

# PERFEXIM

PERFEKT<sup>?</sup> SYSTEM

NEXE  
new line

# CEMENTNIK 2024



[www.perfexim.pl](http://www.perfexim.pl)  
Cennik ważny od 15.03.2024

# PERFEXIM

## LEGENDA



jakość marki  
**PERFEKT**SYSTEM



centralne  
ogrzewanie



lat gwarancji



chłodnictwo



aprobata  
techniczna



glikol



wytrzymałość



powietrze



mosiądz



woda ciepła  
i zimna



atest  
higieniczny



znak  
budowlany



**ZŁOTY LAUR  
KONSUMENTA**  
w kategorii Producent  
i importer branży instalacyjno-  
grzewczej, łazienkowej i sanitarnej

**LAUR  
KONSUMENTA  
- ODKRYCIE ROKU**  
w kategorii Polska jakość  
branży budowlanej. Jakość produktów,  
usług i obecność w świadomości  
konsumentów

# SPIIS TREŚCI

## ARMATURA WODNA

5-30

Kurki kulowe	5
Filtry do wody	11
Zawory zwrotne	12
Zasuwy	13
Zawory antyskażeniowe	13
Zawory przepływowe	13
Zawory zwrotne kulowe różnicowe	14
Zawory żeliwne	14
Kurki i zawory czerpalne	14
Złączki mosiężne wzmocnione	16
Śrubunki mosiężne wzmocnione	19
Złączki mosiężne	20
Śrubunki mosiężne	22
Śrubunki wodomierza	23
Konsole wodomierza	23
Złączki mosiężne chromowane	24
Śrubunki mosiężne chromowane	25
Taśmy teflonowe	26
Kurki i zawory podłączeniowe	26
Przyłącza elastyczne	28

## ARMATURA GAZOWA

32

Kurki kulowe	33
Filtry	33
Przyłącza	33

## ARMATURA CENTRALNEGO OGRZEWANIA

34-54

System antyzamrozeniowy	35
Komplety / głowice termostatyczne	35
Zawory grzejnikowe	39
Zawory bezpieczeństwa	42
Pompy obiegowe	43
Rozdzielacze, osprzęt rozdzielaczy	44
Zawory odpowietrzające	53
Automatyka ogrzewania	54
Uchwyty do bojlerów	54

## SYSTEMY RUROWE WIELOWARSTWOWE

55-67

Rury PERT	56
Rury PEX	56
Złączki zaprasowywane	57
Złączki skręcane	63
System montażowy	66
Narzędzia	67

## RURA MIEDZIANA

72-74

Rury twarde i miękkie	73
-----------------------	----

## GRZEJNIKI PŁYTOWE I ALUMINIOWE

75-80

Grzejniki płytowe C i V	76
Grzejniki aluminiowe	78
Osprzęt grzejników aluminiowych	78
Głowice termostatyczne	78
Osprzęt grzejników stalowych	80

## BATERIE PODTYNKOWE

81-88

Baterie podtynkowe	82
Akcesoria do baterii podtynkowych	86

## ARMATURA KUCHENNA I ŁAZIENKOWA

89-123

Baterie WEGA	90
Baterie RENO	92
Baterie kuchenne i łazienkowe	94
głowica 40	94
głowica 35	98
Baterie ciśnieniowe	108
Syfony	108
Korki zamykające	109
Komplety prysznicowe	114
Słuchawki z deszczownicą	115
Słuchawki	116
Drażki prysznicowe	119
Uchwyty punktowe	120
Wężę prysznicowe	121
Akcesoria łazienkowe z przysawką	122

## AKCESORIA / CZĘŚCI DO BATERII

124-127

Perlatory	125
Przedłużki i pokrętła	126
Głowice do baterii	126
Wylewki do baterii	127
Inne akcesoria	127

## ARMATURA SANITARNA

128-129

Przyłącza	129
Wężę do pralki	129

LAT  
**10**  
GWARANCJI

Pewna, kompletna  
i różnorodna armatura wodna

# PERFEXIM

CENNIK ARMATURA 2024



PERFEKT<sup>2</sup> SYSTEM

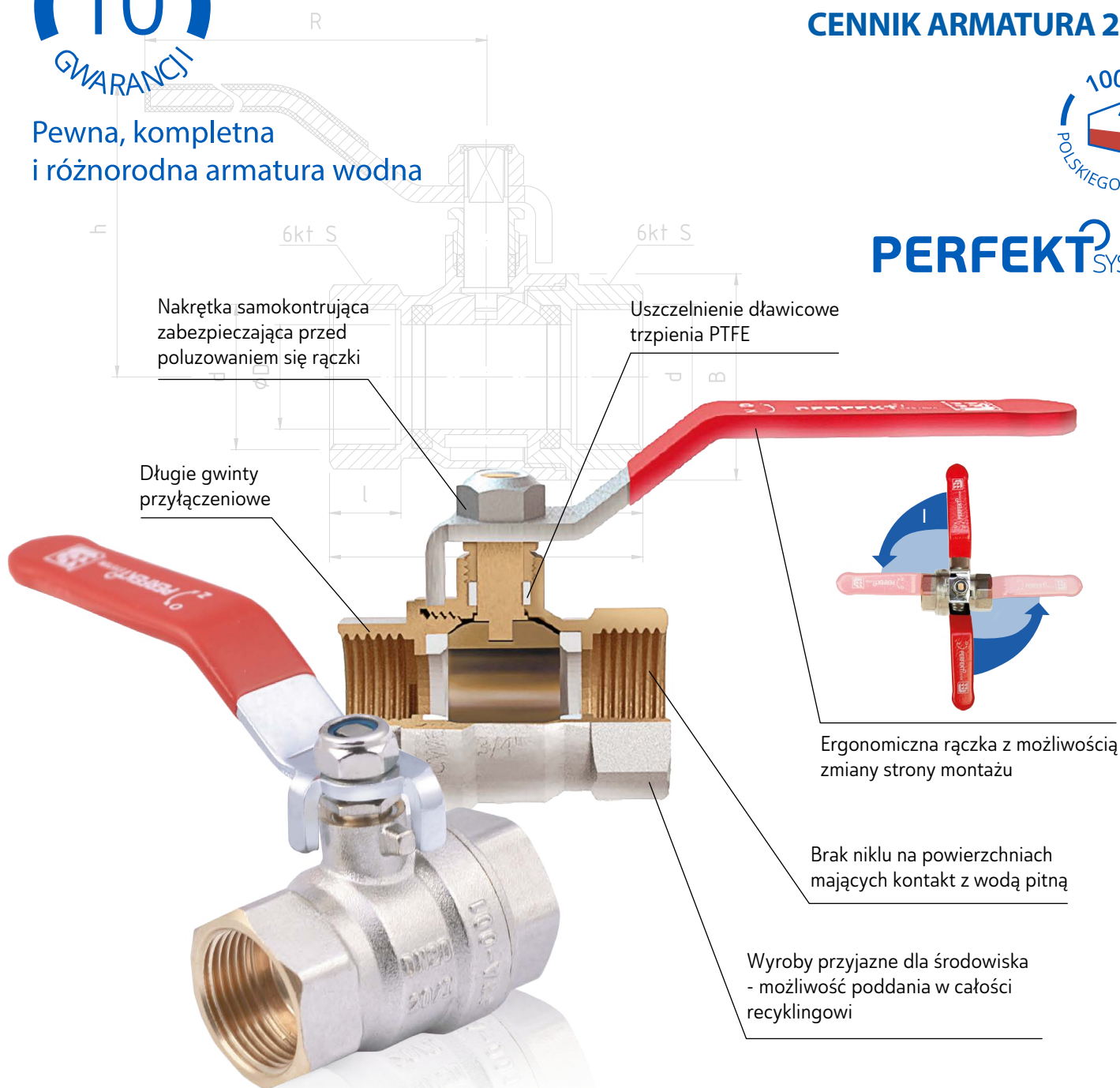

Nakrętka samokontrująca  
zabezpieczająca przed  
poluzowaniem się rączki

Uszczelnienie dławicowe  
trzpienia PTFE

Długie gwinty  
przyłączeniowe

Ergonomiczna rączka z możliwością  
zmiany strony montażu

Brak niklu na powierzchniach  
mających kontakt z wodą pitną

Wyroby przyjazne dla środowiska  
- możliwość poddania w całości  
recyklingowi

# ARMATURA WODNA

## 5-30

Kurki kulowe	5
Filtry do wody	11
Zawory zwrotne	12
Zasuwy	13
Zawory antyskażeniowe	13
Zawory przepływowe	13
Zawory zwrotne kulowe różnicowe	14
Zawory żeliwne	14
Kurki i zawory czerpalne	14
Złączki mosiężne wzmocnione	16
Śrubunki mosiężne wzmocnione	19
Złączki mosiężne	20
Śrubunki mosiężne	22
Śrubunki wodomierza	23
Konsole wodomierza	23
Złączki mosiężne chromowane	24
Śrubunki mosiężne chromowane	25
Taśmy teflonowe	26
Kurki i zawory podłączeniowe	26
Przyłącza elastyczne	28

## PHA-001

PERFEKT SYSTEM  
Kurek kulowy WW

(K) GRUPA RABATOWA

PERFEKT<sup>2</sup> SYSTEM

indeks	wielkość	PN	rodzaj uchwytu	kolor uchwytu	Tmax	pakowanie		cena netto [zł]
00-001-0100-000	3/8"	30	rączka	czerwony	+150°C	10	200	17,67
00-001-0150-000	1/2"	30	rączka	czerwony	+150°C	15	150	23,83
00-001-0200-000	3/4"	30	rączka	czerwony	+150°C	10	100	34,73
00-001-0250-000	1"	30	rączka	czerwony	+150°C	6	60	56,17
00-001-0320-000	1 1/4"	30	rączka	czerwony	+150°C	4	40	88,96
00-001-0400-000	1 1/2"	30	rączka	czerwony	+150°C	4	32	134,15
00-001-0500-000	2"	30	rączka	czerwony	+150°C	2	20	202,13
00-001-0650-000	2 1/2"	30	rączka	czerwony	+150°C	2	10	426,63
00-001-0800-000	3"	30	rączka	czerwony	+150°C	2	4	586,05
00-001-1000-000	4"	30	rączka	czerwony	+150°C	2	4	1032,88

## PHA-001

PERFEKT SYSTEM  
Kurek kulowy WW

(K) GRUPA RABATOWA

PERFEKT<sup>2</sup> SYSTEM

indeks	wielkość	PN	rodzaj uchwytu	kolor uchwytu	Tmax	pakowanie		cena netto [zł]
00-001-0100-001	3/8"	30	rączka	niebieski	+150°C	10	200	17,67
00-001-0150-001	1/2"	30	rączka	niebieski	+150°C	15	150	23,83
00-001-0200-001	3/4"	30	rączka	niebieski	+150°C	10	100	34,73
00-001-0250-001	1"	30	rączka	niebieski	+150°C	6	60	56,17
00-001-0320-001	1 1/4"	30	rączka	niebieski	+150°C	4	40	88,96
00-001-0400-001	1 1/2"	30	rączka	niebieski	+150°C	4	32	134,15
00-001-0500-001	2"	30	rączka	niebieski	+150°C	2	20	202,13
00-001-0650-001	2 1/2"	30	rączka	niebieski	+150°C	2	10	426,63
00-001-0800-001	3"	30	rączka	niebieski	+150°C	2	4	586,05
00-001-1000-001	4"	30	rączka	niebieski	+150°C	2	4	1032,88

## PHA-002

PERFEKT SYSTEM  
Kurek kulowy WW

(K) GRUPA RABATOWA

dostępny w III kwartale 2024

PERFEKT<sup>2</sup> SYSTEM

indeks	wielkość	PN	rodzaj uchwytu	kolor uchwytu	Tmax	pakowanie		cena netto [zł]
00-002-0150-000	1/2"	30	motyl	czerwony	+150°C	15	150	24,70
00-002-0200-000	3/4"	30	motyl	czerwony	+150°C	10	100	33,95
00-002-0250-000	1"	30	motyl	czerwony	+150°C	6	60	55,47
00-002-0320-000	1 1/4"	30	motyl	czerwony	+150°C			87,20

## PHA-002

PERFEKT SYSTEM  
Kurek kulowy WW

(K) GRUPA RABATOWA

PERFEKT<sup>2</sup> SYSTEM

indeks	wielkość	PN	rodzaj uchwytu	kolor uchwytu	Tmax	pakowanie		cena netto [zł]
00-002-0150-001	1/2"	30	motyl	niebieski	+150°C	15	150	24,70
00-002-0200-001	3/4"	30	motyl	niebieski	+150°C	10	100	33,95
00-002-0250-001	1"	30	motyl	niebieski	+150°C	6	60	55,47

## PHA-002C

PERFEKT SYSTEM  
Kurek kulowy z podejściem do czujnika M10x1

(K) GRUPA RABATOWA

PERFEKT<sup>2</sup> SYSTEM

indeks	wielkość	PN	rodzaj uchwytu	kolor uchwytu	Tmax	pakowanie		cena netto [zł]
00-002-0150-003	1/2"	30	motyl	czerwony	+150°C	10	200	32,82
00-002-0200-003	3/4"	30	motyl	czerwony	+150°C	15	150	45,62

## PHA-003

PERFEKT SYSTEM  
Kurek kulowy WZ

(K) GRUPA RABATOWA

dostępny w III kwartale 2024

PERFEKT<sup>2</sup> SYSTEM

indeks	wielkość	PN	rodzaj uchwytu	kolor uchwytu	Tmax	pakowanie		cena netto [zł]
00-003-0150-000	1/2"	30	rączka	czerwony	+150°C	15	150	26,05
00-003-0200-000	3/4"	30	rączka	czerwony	+150°C	10	100	37,88
00-003-0250-000	1"	30	rączka	czerwony	+150°C	6	60	63,54
00-003-0320-000	1 1/4"	30	rączka	czerwony	+150°C			96,10

## PHA-003

PERFEKT SYSTEM  
Kurek kulowy WZ

(K) GRUPA RABATOWA

PERFEKT<sup>2</sup> SYSTEM

indeks	wielkość	PN	rodzaj uchwyty	kolor uchwyty	Tmax	pakowanie		cena netto [zł]
<b>00-003-0150-001</b>	½"	30	rączka	niebieski	+150°C	15	150	<b>26,05</b>
<b>00-003-0200-001</b>	¾"	30	rączka	niebieski	+150°C	10	100	<b>37,88</b>
<b>00-003-0250-001</b>	1"	30	rączka	niebieski	+150°C	6	60	<b>63,54</b>

## PHA-004

PERFEKT SYSTEM  
Kurek kulowy WZ

dostępny w III kwartale 2024

(K) GRUPA RABATOWA

PERFEKT<sup>2</sup> SYSTEM

indeks	wielkość	PN	rodzaj uchwyty	kolor uchwyty	Tmax	pakowanie		cena netto [zł]
<b>00-004-0150-000</b>	½"	30	motyl	czerwony	+150°C	15	150	<b>25,32</b>
<b>00-004-0200-000</b>	¾"	30	motyl	czerwony	+150°C	10	100	<b>35,93</b>
<b>00-004-0250-000</b>	1"	30	motyl	czerwony	+150°C	6	60	<b>59,05</b>
<b>00-004-0320-000</b>	1¼"	30	motyl	czerwony	+150°C			<b>88,40</b>

## PHA-004

PERFEKT SYSTEM  
Kurek kulowy WZ

(K) GRUPA RABATOWA

PERFEKT<sup>2</sup> SYSTEM

indeks	wielkość	PN	rodzaj uchwyty	kolor uchwyty	Tmax	pakowanie		cena netto [zł]
<b>00-004-0150-001</b>	½"	30	motyl	niebieski	+150°C	15	150	<b>25,32</b>
<b>00-004-0200-001</b>	¾"	30	motyl	niebieski	+150°C	10	100	<b>35,93</b>
<b>00-004-0250-001</b>	1"	30	motyl	niebieski	+150°C	6	60	<b>59,05</b>

## PHA-005

PERFEKT SYSTEM  
Kurek kulowy ze śrubunkiem

(K) GRUPA RABATOWA

PERFEKT<sup>2</sup> SYSTEM

indeks	wielkość	PN	rodzaj uchwyty	kolor uchwyty	Tmax	pakowanie		cena netto [zł]
<b>00-005-0150-000</b>	½"	30	motyl	czerwony	+150°C	10	120	<b>28,99</b>
<b>00-005-0200-000</b>	¾"	30	motyl	czerwony	+150°C	10	100	<b>45,40</b>
<b>00-005-0250-000</b>	1"	30	motyl	czerwony	+150°C	6	60	<b>77,62</b>
<b>00-005-0320-000</b>	1¼"	30	motyl	czerwony	+150°C	4	24	<b>113,14</b>

## PHA-005/SM

PERFEKT SYSTEM  
Kurek kulowy ze śrubunkiem

(K) GRUPA RABATOWA

Produkt dostępny do wyczerpania zapasów

PERFEKT<sup>2</sup> SYSTEM

indeks	wielkość	PN	rodzaj uchwyty	kolor uchwyty	Tmax	pakowanie		cena netto [zł]
<b>00-005-0150-200</b>	½"	30	motyl	czerwony	+150°C	10	120	<b>28,99</b>
<b>00-005-0200-200</b>	¾"	30	motyl	czerwony	+150°C	10	100	<b>45,40</b>
<b>00-005-0250-200</b>	1"	30	motyl	czerwony	+150°C	6	60	<b>77,62</b>

## PHA-005/R

PERFEKT SYSTEM  
Kurek kulowy ze śrubunkiem

dostępny w III kwartale 2024

(K) GRUPA RABATOWA

PERFEKT<sup>2</sup> SYSTEM

indeks	wielkość	PN	rodzaj uchwyty	kolor uchwyty	Tmax	pakowanie		cena netto [zł]
<b>00-005-0150-100</b>	½"	30	rączka	czerwony	+150°C	10	120	<b>28,99</b>
<b>00-005-0200-100</b>	¾"	30	rączka	czerwony	+150°C	10	100	<b>45,40</b>
<b>00-005-0250-100</b>	1"	30	rączka	czerwony	+150°C	6	60	<b>77,62</b>
<b>00-005-0320-100</b>	1¼"	30	rączka	czerwony	+150°C	4	24	<b>113,14</b>

## PHA-006

PERFEKT SYSTEM  
Kurek kulowy z filtrem skośnym

(K) GRUPA RABATOWA

PERFEKT<sup>2</sup> SYSTEM

indeks	wielkość	PN	rodzaj uchwyty	kolor uchwyty	Tmax	pakowanie		cena netto [zł]
<b>01-006-0150-000</b>	½"	30	rączka	czerwony	+150°C	8	80	<b>37,89</b>
<b>01-006-0200-000</b>	¾"	30	rączka	czerwony	+150°C	6	60	<b>63,46</b>
<b>01-006-0250-000</b>	1"	30	rączka	czerwony	+150°C	4	40	<b>93,19</b>

## PHA-007

**PERFEKT SYSTEM**  
Kurek kulowy  
ze śrubunkiem

PERFEKT<sup>2</sup>SYSTEM

indeks	wielkość	PN	rodzaj uchwyty	kolor uchwyty	Tmax	pakowanie		cena netto [zł]
<b>00-007-0150-002</b>	½"	30	motylek	czerwony	+140°C	12	120	<b>34,03</b>
<b>00-007-0200-002</b>	¾"	30	motylek	czerwony	+140°C	8	80	<b>52,26</b>
<b>00-007-0250-002</b>	1"	30	motylek	czerwony	+140°C	4	40	<b>88,16</b>

(K) GRUPA RABATOWA

## PHA-007/O

**PERFEKT SYSTEM**  
Kurek kulowy  
z obrotową nakrętką  
z dławikiem



**NOWOŚĆ**

PERFEKT<sup>2</sup>SYSTEM

indeks	wielkość	PN	rodzaj uchwyty	kolor uchwyty	Tmax	pakowanie		cena netto [zł]
<b>00-007-0150-001</b>	½"	30	motylek	czerwony	+140°C	12	144	<b>33,63</b>
<b>00-007-0200-001</b>	¾"	30	motylek	czerwony	+140°C	10	100	<b>49,66</b>
<b>00-007-0250-001</b>	1"	30	motylek	czerwony	+140°C	6	60	<b>80,00</b>
<b>00-007-0320-001</b>	1¼"	30	motylek	czerwony	+140°C	4	32	<b>120,00</b>

(K) GRUPA RABATOWA

Produkt dostępny w II kwartale 2024

## PHA-007/R

**PERFEKT SYSTEM**  
Kurek kulowy  
ze śrubunkiem

PERFEKT<sup>2</sup>SYSTEM

indeks	wielkość	PN	rodzaj uchwyty	kolor uchwyty	Tmax	pakowanie		cena netto [zł]
<b>00-007-0150-102</b>	½"	30	rączka	czerwony	+140°C	10	100	<b>34,03</b>
<b>00-007-0200-102</b>	¾"	30	rączka	czerwony	+140°C	6	60	<b>52,26</b>
<b>00-007-0250-102</b>	1"	30	rączka	czerwony	+140°C	4	40	<b>88,16</b>

(K) GRUPA RABATOWA

## PHA-007A

**PERFEKT SYSTEM**  
Kurek kulowy  
ze śrubunkiem z gwintem  
samoszczelniającym

PERFEKT<sup>2</sup>SYSTEM

indeks	wielkość	PN	rodzaj uchwyty	kolor uchwyty	Tmax	pakowanie		cena netto [zł]
<b>00-007-0250-003</b>	1"	30	motylek	czerwony	+140°C	4	40	<b>89,98</b>

(K) GRUPA RABATOWA

## PHA-008

**PERFEKT SYSTEM**  
Kurek kulowy z zaworem  
spustowym

PERFEKT<sup>2</sup>SYSTEM

indeks	wielkość	PN	rodzaj uchwyty	kolor uchwyty	Tmax	pakowanie		cena netto [zł]
<b>00-008-0150-002</b>	½"	30	rączka	czerwony	+140°C	8	80	<b>38,09</b>
<b>00-008-0200-002</b>	¾"	30	rączka	czerwony	+140°C	6	60	<b>48,39</b>
<b>00-008-0250-002</b>	1"	30	rączka	czerwony	+140°C	4	40	<b>72,06</b>

(K) GRUPA RABATOWA

## PHA-010

**PERFEKT SYSTEM**  
Kurek kulowy kątowy  
ze śrubunkiem

PERFEKT<sup>2</sup>SYSTEM

indeks	wielkość	PN	rodzaj uchwyty	kolor uchwyty	Tmax	pakowanie		cena netto [zł]
<b>00-010-0150-000</b>	½"	30	motyl	czerwony	+140°C	10	80	<b>37,45</b>
<b>00-010-0200-000</b>	¾"	30	motyl	czerwony	+140°C	6	40	<b>54,98</b>
<b>00-010-0250-000</b>	1"	30	motyl	czerwony	+140°C	5	40	<b>90,76</b>
<b>00-010-0320-000</b>	1¼"	30	motyl	czerwony	+140°C			

dostępny w III kwartale 2024

(K) GRUPA RABATOWA

## PHA-010A

**PERFEKT SYSTEM**  
Kurek kulowy kątowy  
ze śrubunkiem z gwintem  
samoszczelniającym

PERFEKT<sup>2</sup>SYSTEM

indeks	wielkość	PN	rodzaj uchwyty	kolor uchwyty	Tmax	pakowanie		cena netto [zł]
<b>00-010-0250-002</b>	1"	30	motyl	czerwony	+140°C	5	40	<b>92,66</b>
<b>00-010-0250-003</b>	1"	30	motyl	niebieski	+140°C	5	40	<b>92,66</b>

(K) GRUPA RABATOWA

**PHA-010/O****PERFEKT SYSTEM**

Kurek kulowy kątowny z obrotową nakrętką

**NOWOŚĆ****PERFEKT SYSTEM**

indeks	wielkość	PN	rodzaj uchwyty	kolor uchwyty	Tmax	pakowanie		cena netto [zł]
<b>00-010-0150-001</b>	½"	30	motyl	czerwony	+140°C	12	120	<b>38,30</b>
<b>00-010-0200-001</b>	¾"	30	motyl	czerwony	+140°C	8	80	<b>60,33</b>
<b>00-010-0250-001</b>	1"	30	motyl	czerwony	+140°C	6	48	<b>92,50</b>
<b>00-010-0320-001</b>	1¼"	30	motyl	czerwony	+140°C	4	24	<b>138,55</b>

**(K)** GRUPA RABATOWA

Produkt dostępny w II kwartale 2024

**RN-PHA**

Rączka do kurków kulowych PHA-001 i PHA-003, z ergonomiczną rączką, z etykietką na kurku

**PERFEKT SYSTEM**

indeks	kolor	indeks	kolor	wielkość	pakowanie		cena netto [zł]
<b>01-900-1001-150</b>	czerwony	<b>01-900-1011-150</b>	niebieski	½"	1	1	<b>2,00</b>
<b>01-900-1001-200</b>	czerwony	<b>01-900-1011-200</b>	niebieski	¾"	1	1	<b>2,42</b>
<b>01-900-1001-250</b>	czerwony	<b>01-900-1011-250</b>	niebieski	1"	1	1	<b>4,11</b>
<b>01-900-1001-320</b>	czerwony	<b>01-900-1011-320</b>	niebieski	1¼"	1	1	<b>6,29</b>
<b>01-900-1001-400</b>	czerwony	<b>01-900-1011-400</b>	niebieski	1½"	1	1	<b>8,56</b>
<b>01-900-1001-500</b>	czerwony	<b>01-900-1011-500</b>	niebieski	2"	1	1	<b>12,85</b>

**(K)** GRUPA RABATOWA**MN-PHA**

Motyl do kurków kulowych PHA-002 i PHA-004 z etykietką na kurku

**PERFEKT SYSTEM**

indeks	kolor	indeks	kolor	wielkość	pakowanie		cena netto [zł]
<b>01-900-1010-150</b>	czerwony	<b>01-900-1012-150</b>	niebieski	½"	1	1	<b>2,00</b>
<b>01-900-1010-200</b>	czerwony	<b>01-900-1012-200</b>	niebieski	¾"	1	1	<b>2,42</b>
<b>01-900-1010-250</b>	czerwony	<b>01-900-1012-250</b>	niebieski	1"	1	1	<b>4,11</b>

**(K)** GRUPA RABATOWA**PHA-200/1****HUZAR**

kurek kulowy WW

**PERFEKT SYSTEM**

indeks	wielkość	PN	rodzaj uchwyty	kolor uchwyty	Tmax	pakowanie		cena netto [zł]
<b>00-006-0150-000</b>	½"	40	rączka	czarny	+180°C	10	90	<b>38,44</b>
<b>00-006-0200-000</b>	¾"	40	rączka	czarny	+180°C	10	60	<b>62,84</b>
<b>00-006-0250-000</b>	1"	40	rączka	czarny	+180°C	6	36	<b>96,34</b>
<b>00-006-0320-000</b>	1¼"	40	rączka	czarny	+180°C	4	24	<b>157,12</b>
<b>00-006-0400-000</b>	1½"	40	rączka	czarny	+180°C	2	18	<b>219,94</b>
<b>00-006-0500-000</b>	2"	40	rączka	czarny	+180°C	2	8	<b>368,64</b>

**(K)** GRUPA RABATOWA**PHA-200/2****HUZAR**

kurek kulowy WZ

**PERFEKT SYSTEM**

indeks	wielkość	PN	rodzaj uchwyty	kolor uchwyty	Tmax	pakowanie		cena netto [zł]
<b>00-007-0150-000</b>	½"	40	rączka	czarny	+180°C	10	90	<b>37,42</b>
<b>00-007-0200-000</b>	¾"	40	rączka	czarny	+180°C	10	60	<b>61,18</b>
<b>00-007-0250-000</b>	1"	40	rączka	czarny	+180°C	6	36	<b>93,79</b>

**(K)** GRUPA RABATOWA**PHA-200/3****HUZAR**

kurek kulowy WW

**PERFEKT SYSTEM**

indeks	wielkość	PN	rodzaj uchwyty	kolor uchwyty	Tmax	pakowanie		cena netto [zł]
<b>00-008-0150-000</b>	½"	40	motyl	czarny	+180°C	10	90	<b>36,71</b>
<b>00-008-0200-000</b>	¾"	40	motyl	czarny	+180°C	10	60	<b>60,27</b>
<b>00-008-0250-000</b>	1"	40	motyl	czarny	+180°C	6	36	<b>93,79</b>

**(K)** GRUPA RABATOWA**PHA-200/4****HUZAR**

kurek kulowy WZ

**PERFEKT SYSTEM**

indeks	wielkość	PN	rodzaj uchwyty	kolor uchwyty	Tmax	pakowanie		cena netto [zł]
<b>00-009-0150-000</b>	½"	40	motyl	czarny	+180°C	10	90	<b>37,42</b>
<b>00-009-0200-000</b>	¾"	40	motyl	czarny	+180°C	10	60	<b>61,18</b>
<b>00-009-0250-000</b>	1"	40	motyl	czarny	+180°C	6	36	<b>93,79</b>

**(K)** GRUPA RABATOWA

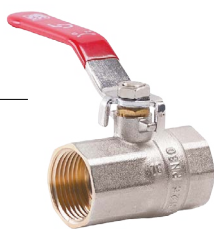

**KX01****KROS**  
kurek kulowy WW

GRUPA RABATOWA

indeks	wielkość	PN	rodzaj uchwytu	kolor uchwytu	Tmax	pakowanie		cena netto [zł]
<b>KX01-0150-000</b>	½"	30	rączka	czerwony	+130°C	15	150	<b>20,18</b>
<b>KX01-0200-000</b>	¾"	30	rączka	czerwony	+130°C	10	100	<b>29,37</b>
<b>KX01-0250-000</b>	1"	30	rączka	czerwony	+130°C	6	60	<b>46,26</b>
<b>KX01-0320-000</b>	1¼"	30	rączka	czerwony	+130°C	4	40	<b>74,17</b>
<b>KX01-0400-000</b>	1½"	30	rączka	czerwony	+130°C	4	32	<b>109,47</b>
<b>KX01-0500-000</b>	2"	30	rączka	czerwony	+130°C	2	20	<b>168,05</b>
<b>KX01-0650-000</b>	2½"	30	rączka	czerwony	+130°C	2	10	<b>342,11</b>

**KX02****KROS**  
kurek kulowy WW

GRUPA RABATOWA

indeks	wielkość	PN	rodzaj uchwytu	kolor uchwytu	Tmax	pakowanie		cena netto [zł]
<b>KX02-0150-000</b>	½"	30	motyl	czerwony	+130°C	15	150	<b>20,38</b>
<b>KX02-0200-000</b>	¾"	30	motyl	czerwony	+130°C	10	100	<b>29,98</b>
<b>KX02-0250-000</b>	1"	30	motyl	czerwony	+130°C	6	60	<b>47,80</b>

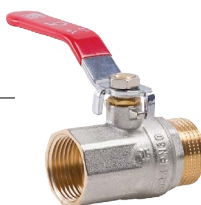
**KX03****KROS**  
kurek kulowy WZ

GRUPA RABATOWA

indeks	wielkość	PN	rodzaj uchwytu	kolor uchwytu	Tmax	pakowanie		cena netto [zł]
<b>KX03-0150-000</b>	½"	30	rączka	czerwony	+130°C	15	150	<b>21,18</b>
<b>KX03-0200-000</b>	¾"	30	rączka	czerwony	+130°C	10	100	<b>31,20</b>
<b>KX03-0250-000</b>	1"	30	rączka	czerwony	+130°C	6	60	<b>49,04</b>

**KX04****KROS**  
kurek kulowy WZ

GRUPA RABATOWA

indeks	wielkość	PN	rodzaj uchwytu	kolor uchwytu	Tmax	pakowanie		cena netto [zł]
<b>KX04-0150-000</b>	½"	30	motyl	czerwony	+130°C	15	150	<b>20,50</b>
<b>KX04-0200-000</b>	¾"	30	motyl	czerwony	+130°C	10	100	<b>31,53</b>
<b>KX04-0250-000</b>	1"	30	motyl	czerwony	+130°C	6	60	<b>52,03</b>

**KX06****KROS**  
kurek kulowy z filtrem skośnym

GRUPA RABATOWA

indeks	wielkość	PN	rodzaj uchwytu	kolor uchwytu	Tmax	pakowanie		cena netto [zł]
<b>KX06-0250-000</b>	1"	10	rączka	czerwony	+120°C	4	40	<b>76,29</b>

**1040WW**

Kurek kulowy WW



GRUPA RABATOWA

indeks	wielkość	PN	rodzaj uchwytu	kolor uchwytu	Tmax	pakowanie		cena netto [zł]
<b>00-200-0150-010</b>	½"	16	rączka	czerwony	+120°C	16	160	<b>19,52</b>
<b>00-200-0200-010</b>	¾"	16	rączka	czerwony	+120°C	12	120	<b>27,05</b>
<b>00-200-0250-010</b>	1"	16	rączka	czerwony	+120°C	6	60	<b>44,07</b>
<b>00-200-0320-010</b>	1¼"	16	rączka	czerwony	+120°C	4	40	<b>67,43</b>
<b>00-200-0400-010</b>	1½"	16	rączka	czerwony	+120°C	4	32	<b>103,26</b>
<b>00-200-0500-010</b>	2"	16	rączka	czerwony	+120°C	2	20	<b>170,89</b>

**1041WW**

Kurek kulowy WW



GRUPA RABATOWA

indeks	wielkość	PN	rodzaj uchwytu	kolor uchwytu	Tmax	pakowanie		cena netto [zł]
<b>00-220-0150-010</b>	½"	16	motyl	czerwony	+120°C	16	160	<b>20,06</b>
<b>00-220-0200-010</b>	¾"	16	motyl	czerwony	+120°C	12	120	<b>27,30</b>
<b>00-220-0250-010</b>	1"	16	motyl	czerwony	+120°C	6	60	<b>46,41</b>



**1040WZ**

Kurek kulowy WZ



**(A)** GRUPA RABATOWA

indeks	wielkość	PN	rodzaj uchwytu	kolor uchwytu	Tmax	pakowanie		cena netto [zł]
<b>00-202-0150-010</b>	½"	16	rączka	czerwony	+120°C	16	160	<b>19,83</b>
<b>00-202-0200-010</b>	¾"	16	rączka	czerwony	+120°C	12	120	<b>28,38</b>
<b>00-202-0250-010</b>	1"	16	rączka	czerwony	+120°C	6	60	<b>47,63</b>

**1041WZ**

Kurek kulowy WZ



**(A)** GRUPA RABATOWA

indeks	wielkość	PN	rodzaj uchwytu	kolor uchwytu	Tmax	pakowanie		cena netto [zł]
<b>00-222-0150-010</b>	½"	16	motyl	czerwony	+120°C	16	160	<b>20,72</b>
<b>00-222-0200-010</b>	¾"	16	motyl	czerwony	+120°C	12	120	<b>28,13</b>
<b>00-222-0250-010</b>	1"	16	motyl	czerwony	+120°C	6	60	<b>48,22</b>

**1410WW**

Kurek kulowy z dławikiem WW

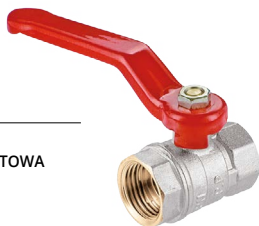

**(A)** GRUPA RABATOWA

indeks	wielkość	PN	rodzaj uchwytu	kolor uchwytu	Tmax	pakowanie		cena netto [zł]
<b>00-200-0650-000</b>	2½"	10	rączka	czerwony	+120°C	2	10	<b>299,30</b>
<b>00-200-0800-000</b>	3"	10	rączka	czerwony	+120°C	2	4	<b>445,16</b>
<b>00-200-1000-000</b>	4"	10	rączka	czerwony	+120°C	2	4	<b>728,84</b>

**1504**

Kurek kulowy do wlotowania



**(E)** GRUPA RABATOWA

Produkt dostępny do wyczerpania zapasów

indeks	wielkość	PN	rodzaj uchwytu	kolor uchwytu	Tmax	pakowanie		cena netto [zł]
<b>01-304-0150-000</b>	15	10	rączka	czerwony	+120°C	16	160	<b>21,74</b>
<b>01-304-0280-000</b>	28	10	rączka	czerwony	+120°C	6	60	<b>57,42</b>

**65RU**

Kurek kulowy z zaworem spustowym WW



**(E)** GRUPA RABATOWA

indeks	wielkość	PN	rodzaj uchwytu	kolor uchwytu	Tmax	pakowanie		cena netto [zł]
<b>01-303-0150-000</b>	½"	30	rączka	czerwony	+120°C	8	80	<b>35,24</b>
<b>01-303-0200-000</b>	¾"	30	rączka	czerwony	+120°C	6	60	<b>44,69</b>
<b>01-303-0250-000</b>	1"	30	rączka	czerwony	+120°C	4	40	<b>65,92</b>
<b>01-303-0320-000</b>	1¼"	25	rączka	czerwony	+120°C	2	32	<b>103,32</b>
<b>01-303-0400-000</b>	1½"	25	rączka	czerwony	+120°C	2	24	<b>149,01</b>
<b>01-303-0500-000</b>	2"	25	rączka	czerwony	+120°C	2	16	<b>218,56</b>

**PHA-019D****PERFEKT SYSTEM**

Kurek kul. z dław. ze złączką do łączenia z rurą PEX lub PERT

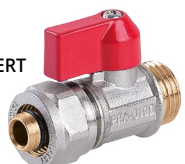

**(K)** GRUPA RABATOWA

**PERFEKT<sup>2</sup>SYSTEM**

indeks	wielkość	PN	rodzaj uchwytu	kolor uchwytu	Tmax	pakowanie		cena netto [zł]
<b>01-019-0000-001</b>	½"	16	rączka	czerwony	+120°C	17	170	<b>20,38</b>
<b>01-019-1000-001</b>	½"	16	rączka	niebieski	+120°C	17	170	<b>20,38</b>

**PHA-019S****PERFEKT SYSTEM**

Kurek kulowy spustowy z dławikiem ze złączką do węży



**(K)** GRUPA RABATOWA

**PERFEKT<sup>2</sup>SYSTEM**

indeks	wielkość	PN	rodzaj uchwytu	kolor uchwytu	Tmax	pakowanie		cena netto [zł]
<b>01-019-0000-002</b>	½"	16	rączka	czerwony	+120°C	25	250	<b>20,97</b>
<b>01-019-1000-002</b>	½"	16	rączka	niebieski	+120°C	25	250	<b>20,97</b>



## 1809

Kurek kulowy spustowy  
ze złączką do węża

indeks	wielkość	PN	rodzaj uchwyty	kolor uchwyty	Tmax	pakowanie		cena netto [zł]
<b>20-205-0150-000</b>	½"	25	rączka	czerwony	+150°C	15	150	<b>28,14</b>
<b>20-205-0200-000</b>	¾"	25	rączka	czerwony	+150°C	15	120	<b>39,34</b>

E GRUPA RABATOWA



## 3021WW

Kurek kulowy  
typ MINI WW

indeks	wielkość	PN	rodzaj uchwyty	kolor uchwyty	Tmax	pakowanie		cena netto [zł]
<b>01-301-0150-000</b>	½"	16	rączka	czerwony	+120°C	20	180	<b>19,76</b>

E GRUPA RABATOWA



## 3021WZ

Kurek kulowy  
typ MINI WZ

indeks	wielkość	PN	rodzaj uchwyty	kolor uchwyty	Tmax	pakowanie		cena netto [zł]
<b>01-302-0150-001</b>	½"	16	rączka	czerwony	+120°C	25	250	<b>19,08</b>

E GRUPA RABATOWA



## 428CH

Kurek kulowy  
podtynkowy

indeks	wielkość	PN	Tmax	pakowanie		cena netto [zł]
<b>01-305-0150-000</b>	½"	30	+120°C	5	50	<b>66,13</b>
<b>01-305-0200-000</b>	¾"	30	+120°C	4	40	<b>76,96</b>

E GRUPA RABATOWA



## PHA-060

PERFEKT SYSTEM  
Filtr skośny do wody

indeks	wielkość	PN	Tmax	pakowanie		cena netto [zł]
<b>03-060-0150-000</b>	½"	25	+150°C	18	180	<b>19,74</b>
<b>03-060-0200-000</b>	¾"	25	+150°C	12	120	<b>31,25</b>
<b>03-060-0250-000</b>	1"	25	+150°C	10	100	<b>42,97</b>
<b>03-060-0320-000</b>	1¼"	25	+150°C	4	40	<b>82,97</b>
<b>03-060-0400-000</b>	1½"	25	+150°C	3	30	<b>109,37</b>
<b>03-060-0500-000</b>	2"	25	+150°C	2	20	<b>178,51</b>
<b>03-060-0650-000</b>	2½"	20	+150°C	1	10	<b>284,27</b>
<b>03-060-0800-000</b>	3"	20	+150°C	1	10	<b>446,36</b>

K GRUPA RABATOWA



## PHA-060M

PERFEKT SYSTEM  
Filtr skośny do wody  
z wkładem magnetycznym

indeks	wielkość	PN	Tmax	pakowanie		cena netto [zł]
<b>03-060-0150-100</b>	½"	25	+150°C	18	180	<b>46,00</b>
<b>03-060-0200-100</b>	¾"	25	+150°C	12	120	<b>56,00</b>
<b>03-060-0250-100</b>	1"	25	+150°C	10	100	<b>65,00</b>
<b>03-060-0320-100</b>	1¼"	25	+150°C	4	10	<b>210,24</b>
<b>03-060-0400-100</b>	1½"	25	+150°C	3	10	<b>239,26</b>
<b>03-060-0500-100</b>	2"	25	+150°C	2	10	<b>368,83</b>

K GRUPA RABATOWA

dostępne w III kwartale 2024



## US-060

Uszczelka i siatka do filtra  
PHA-060

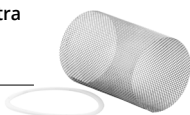

**(K)** GRUPA RABATOWA

PERFEKT<sup>SYSTEM</sup>

indeks	wielkość	pakowanie		cena netto [zł]
<b>03-200-0000-150</b>	½"	1	1	<b>1,80</b>
<b>03-200-0000-200</b>	¾"	1	1	<b>2,76</b>
<b>03-200-0000-250</b>	1"	1	1	<b>3,59</b>
<b>03-200-0000-320</b>	1¼"	1	1	<b>7,15</b>
<b>03-200-0000-400</b>	1½"	1	1	<b>9,49</b>
<b>03-200-0000-500</b>	2"	1	1	<b>13,77</b>
<b>03-200-0000-650</b>	2½"	1	1	<b>16,00</b>
<b>03-200-0000-800</b>	3"	1	1	<b>21,00</b>

## 5503

Zawór zwrotny  
z mosiężnym grzybkiem



**(B)** GRUPA RABATOWA

indeks	wielkość	PN	Tmax	pakowanie		cena netto [zł]
<b>04-100-0150-000</b>	½"	10	+120°C	16	192	<b>19,29</b>
<b>04-100-0200-000</b>	¾"	10	+120°C	10	150	<b>24,78</b>
<b>04-100-0250-000</b>	1"	10	+120°C	9	108	<b>32,52</b>
<b>04-100-0320-000</b>	1¼"	10	+120°C	6	48	<b>58,21</b>
<b>04-100-0400-000</b>	1½"	10	+120°C	2	40	<b>77,67</b>
<b>04-100-0500-000</b>	2"	10	+120°C	2	30	<b>116,55</b>
<b>04-100-0650-000</b>	2½"	8	+120°C	2	10	<b>194,30</b>

## 5503/P

Zawór zwrotny  
z grzybkiem z tworzywa



**(B)** GRUPA RABATOWA

indeks	wielkość	PN	Tmax	pakowanie		cena netto [zł]
<b>04-100-0150-100</b>	½"	10	+120°C	16	192	<b>18,20</b>
<b>04-100-0200-100</b>	¾"	10	+120°C	10	150	<b>23,86</b>
<b>04-100-0250-100</b>	1"	10	+120°C	9	108	<b>31,57</b>
<b>04-100-0320-100</b>	1¼"	10	+120°C	6	48	<b>57,05</b>
<b>04-100-0400-100</b>	1½"	10	+120°C	2	40	<b>76,17</b>
<b>04-100-0500-100</b>	2"	10	+120°C	2	30	<b>114,26</b>

## PHA-020

**PERFEKT SYSTEM**  
Zawór zwrotny  
z mosiężnym grzybkiem

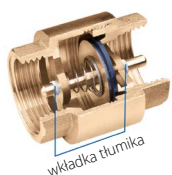

**(K)** GRUPA RABATOWA

PERFEKT<sup>SYSTEM</sup>

indeks	wielkość	PN	Tmax	pakowanie		cena netto [zł]
<b>04-020-0150-000</b>	½"	16	+120°C	19	228	<b>21,36</b>
<b>04-020-0200-000</b>	¾"	16	+120°C	12	144	<b>29,54</b>
<b>04-020-0250-000</b>	1"	16	+120°C	9	108	<b>42,15</b>
<b>04-020-0320-000</b>	1¼"	10	+120°C	6	72	<b>61,53</b>
<b>04-020-0400-000</b>	1½"	10	+120°C	6	36	<b>94,60</b>
<b>04-020-0500-000</b>	2"	10	+120°C	1	30	<b>133,37</b>
<b>04-020-0650-000</b>	2½"	10	+120°C	1	16	<b>283,25</b>
<b>04-020-0800-000</b>	3"	10	+120°C	1	12	<b>387,81</b>
<b>04-020-1000-000</b>	4"	10	+120°C	1	4	<b>652,52</b>

## PHA-KS1

**PERFEKT SYSTEM**  
Kosz ssawny do zaworu  
zwrotnego PHA-020



**(K)** GRUPA RABATOWA

PERFEKT<sup>SYSTEM</sup>

indeks	wielkość	pakowanie		cena netto [zł]
<b>04-901-0150-000</b>	½"	54	648	<b>5,00</b>
<b>04-901-0200-000</b>	¾"	28	336	<b>6,84</b>
<b>04-901-0250-000</b>	1"	30	180	<b>9,09</b>
<b>04-901-0320-000</b>	1¼"	20	120	<b>11,21</b>
<b>04-901-0400-000</b>	1½"	6	72	<b>12,93</b>
<b>04-901-0500-000</b>	2"	4	48	<b>16,79</b>
<b>04-901-0650-000</b>	2½"	1	28	<b>29,56</b>
<b>04-901-0800-000</b>	3"	1	22	<b>34,09</b>
<b>04-901-1000-000</b>	4"	1	12	<b>49,64</b>

## PHA-021

**PERFEKT SYSTEM**  
Zawór zwrotny klapkowy



**(K)** GRUPA RABATOWA

PERFEKT<sup>SYSTEM</sup>

indeks	wielkość	PN	Tmax	pakowanie	cena netto [zł]
<b>04-021-0150-000</b>	½"	16	+120°C	12 144	<b>27,46</b>
<b>04-021-0200-000</b>	¾"	16	+120°C	10 80	<b>37,32</b>
<b>04-021-0250-000</b>	1"	16	+120°C	8 96	<b>53,52</b>
<b>04-021-0320-000</b>	1¼"	10	+120°C	6 36	<b>94,12</b>
<b>04-021-0400-000</b>	1½"	10	+120°C	4 24	<b>118,92</b>
<b>04-021-0500-000</b>	2"	10	+120°C	2 12	<b>164,35</b>
<b>04-021-0650-000</b>	2½"	10	+120°C	1 12	<b>280,49</b>
<b>04-021-0800-000</b>	3"	10	+120°C	1 8	<b>411,37</b>

## PHA-013

**PERFEKT SYSTEM**  
Zawór antyskażeniowy typ "EA"



**(K)** GRUPA RABATOWA

PERFEKT<sup>SYSTEM</sup>

indeks	wielkość	PN	Tmax	pakowanie	cena netto [zł]
<b>01-013-0150-000</b>	½"	10	+65°C	18 180	<b>24,39</b>
<b>01-013-0200-000</b>	¾"	10	+65°C	16 128	<b>32,40</b>
<b>01-013-0250-000</b>	1"	10	+65°C	10 180	<b>49,09</b>

## PHA-022

**PERFEKT SYSTEM**  
Zasuwa mosiężna



**(K)** GRUPA RABATOWA

PERFEKT<sup>SYSTEM</sup>

indeks	wielkość	PN	Tmax	pakowanie	cena netto [zł]
<b>01-022-0150-000</b>	½"	10	+100°C	20 80	<b>30,72</b>
<b>01-022-0200-000</b>	¾"	10	+100°C	15 60	<b>41,22</b>
<b>01-022-0250-000</b>	1"	10	+100°C	8 48	<b>60,96</b>
<b>01-022-0320-000</b>	1¼"	10	+100°C	2 24	<b>90,55</b>
<b>01-022-0400-000</b>	1½"	10	+100°C	2 24	<b>119,37</b>
<b>01-022-0500-000</b>	2"	10	+100°C	3 12	<b>190,34</b>
<b>01-022-0650-000</b>	2½"	10	+100°C	2 12	<b>345,16</b>
<b>01-022-0800-000</b>	3"	10	+100°C	2 8	<b>474,11</b>

## 1620

Zawór antyskażeniowy skośny

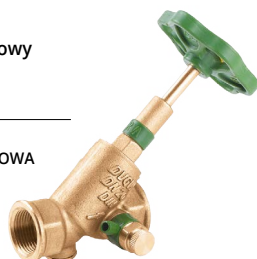

**(C)** GRUPA RABATOWA

indeks	wielkość	PN	Tmax	pakowanie	cena netto [zł]
<b>01-402-0150-000</b>	½"	10	+90°C	1 20	<b>89,13</b>
<b>01-402-0200-000</b>	¾"	10	+90°C	1 10	<b>109,60</b>
<b>01-402-0250-000</b>	1"	10	+90°C	1 5	<b>139,85</b>
<b>01-402-0320-000</b>	1¼"	10	+90°C	1 4	<b>246,13</b>
<b>01-402-0400-000</b>	1½"	10	+90°C	1 1	<b>289,01</b>
<b>01-402-0500-000</b>	2"	10	+90°C	1 1	<b>447,47</b>

## 1505

Zawór przepływowy skośny

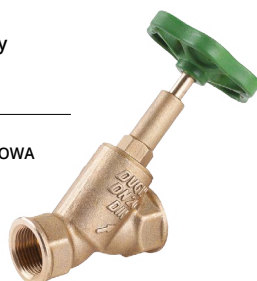

**(C)** GRUPA RABATOWA

indeks	wielkość	PN	Tmax	pakowanie	cena netto [zł]
<b>01-401-0150-000</b>	½"	10	+90°C	1 20	<b>35,82</b>
<b>01-401-0200-000</b>	¾"	10	+90°C	1 10	<b>56,75</b>
<b>01-401-0250-000</b>	1"	10	+90°C	1 5	<b>74,47</b>
<b>01-401-0320-000</b>	1¼"	10	+90°C	1 4	<b>151,17</b>
<b>01-401-0400-000</b>	1½"	10	+90°C	1 1	<b>174,73</b>
<b>01-401-0500-000</b>	2"	10	+90°C	1 1	<b>311,00</b>

## 1105

Zawór przepływowy grzybkowy prosty



**(C)** GRUPA RABATOWA

indeks	wielkość	PN	Tmax	pakowanie	cena netto [zł]
<b>01-400-0150-000</b>	½"	10	+90°C	1 20	<b>42,54</b>
<b>01-400-0200-000</b>	¾"	10	+90°C	1 15	<b>58,01</b>
<b>01-400-0250-000</b>	1"	10	+90°C	1 10	<b>91,63</b>
<b>01-400-0320-000</b>	1¼"	10	+90°C	1 5	<b>155,55</b>
<b>01-400-0400-000</b>	1½"	10	+90°C	1 3	<b>222,69</b>
<b>01-400-0500-000</b>	2"	10	+90°C	1 1	<b>323,94</b>

**ZKR-111**

Zawór zwrotny kulowy różnicowy

**D** GRUPA RABATOWA

indeks	wielkość	PN	Tmax	pakowanie		cena netto [zł]
<b>04-101-0250-000</b>	1"	6	+120°C	1	24	<b>70,34</b>
<b>04-101-0320-000</b>	1¼"	6	+120°C	1	18	<b>78,08</b>
<b>04-101-0400-000</b>	1½"	6	+120°C	1	16	<b>90,36</b>
<b>04-101-0500-000</b>	2"	6	+120°C	1	12	<b>111,54</b>

**G02**

Głowica do zaworów żeliwnych z uszczelką płaską fibrową

**B** GRUPA RABATOWA

indeks	wielkość	PN	Tmax	pakowanie		cena netto [zł]
<b>01-500-0150-000</b>	½"	10	+90°C	20	120	<b>16,07</b>
<b>01-500-0200-000</b>	¾"	10	+90°C	20	120	<b>19,80</b>
<b>01-500-0250-000</b>	1"	10	+90°C	15	60	<b>27,20</b>
<b>01-500-0320-000</b>	1¼"	10	+90°C	10	80	<b>58,47</b>
<b>01-500-0400-000</b>	1½"	10	+90°C	5	60	<b>71,12</b>
<b>01-500-0500-000</b>	2"	10	+90°C	5	30	<b>111,51</b>

**3098**

Zawór żeliwny ocynkowany przelotowy prosty

**B** GRUPA RABATOWA

indeks	wielkość	PN	Tmax	pakowanie		cena netto [zł]
<b>01-400-0150-100</b>	½"	10	+120°C	8	64	<b>24,00</b>
<b>01-400-0200-100</b>	¾"	10	+120°C	8	48	<b>31,00</b>
<b>01-400-0250-100</b>	1"	10	+120°C	4	24	<b>46,50</b>
<b>01-400-0320-100</b>	1¼"	10	+120°C	3	18	<b>92,30</b>
<b>01-400-0400-100</b>	1½"	10	+120°C	4	16	<b>134,34</b>
<b>01-400-0500-100</b>	2"	10	+120°C	2	8	<b>227,33</b>

**3099**

Zawór żeliwny ocynkowany czerpalny z szybkozłączką do węża

**B** GRUPA RABATOWA

indeks	wielkość	PN	Tmax	pakowanie		cena netto [zł]
<b>01-009-0150-005</b>	½"	10	+120°C	8	32	<b>33,43</b>
<b>01-009-0200-005</b>	¾"	10	+120°C	7	28	<b>48,47</b>

**PHA-070**

Kurek kulowy czerpalny mrozoodporny

**K** GRUPA RABATOWA**PERFEKT<sup>SYSTEM</sup>**

indeks	wielkość	PN	Tmax	pakowanie		cena netto [zł]
<b>01-070-0150-000</b>	½"	15	+120°C	12	120	<b>29,36</b>
<b>01-070-0200-000</b>	¾"	20	+120°C	10	100	<b>40,17</b>

**3102**

Kurek kulowy czerpalny ze złączką do węża

**B** GRUPA RABATOWA

indeks	wielkość	PN	Tmax	pakowanie		cena netto [zł]
<b>01-009-0150-002</b>	½"	10	+80°C	10	100	<b>23,92</b>
<b>01-009-0200-002</b>	¾"	10	+80°C	10	100	<b>33,22</b>
<b>01-009-0250-002</b>	1"	10	+80°C	5	40	<b>53,74</b>

**PHA-009****PERFEKT SYSTEM**

Kurek kulowy czerpalny z dławikiem ze złączką do węża

**(K)** GRUPA RABATOWA**PERFEKT SYSTEM**

indeks	wielkość	PN	Tmax	pakowanie		cena netto [zł]
<b>01-009-0150-000</b>	½"	16	+120°C	10	100	<b>26,33</b>
<b>01-009-0200-000</b>	¾"	16	+120°C	10	100	<b>37,14</b>
<b>01-009-0250-000</b>	1"	16	+120°C	5	40	<b>61,56</b>

**PHA-009 DUO****PERFEKT SYSTEM**

Kurek kulowy czerpalny podwójny

**(K)** GRUPA RABATOWA**PERFEKT SYSTEM**

indeks	wielkość	PN	Tmax	pakowanie		cena netto [zł]
<b>01-009-0150-006</b>	½"	16	+120°C			



Produkt dostępny w III kwartale 2024

**PHA-009S****PERFEKT SYSTEM**

Kurek kulowy czerpalny z dławikiem z szybkozłączką do węża

**(K)** GRUPA RABATOWA**PERFEKT SYSTEM**

indeks	wielkość	PN	Tmax	pakowanie		cena netto [zł]
<b>01-009-0150-001</b>	½"	16	+120°C	10	100	<b>26,33</b>
<b>01-009-0200-001</b>	¾"	16	+120°C	10	100	<b>37,14</b>

**PHA-015****PERFEKT SYSTEM**

Zawór czerpalny grzybkowy mosiężny chromowany

**(K)** GRUPA RABATOWA**PERFEKT SYSTEM**

indeks	wielkość	PN	Tmax	pakowanie		cena netto [zł]
<b>01-015-0150-000</b>	½"	10	+90°C	1	48	<b>51,58</b>

**Adapter**

Adapter (redukcja) do zbiornika IBC

**(B)** GRUPA RABATOWA

indeks	wielkość	Tmax	pakowanie		cena netto [zł]
<b>01-009-0150-010</b>	½"	+65°C	1	300	<b>24,10</b>
<b>01-009-0200-010</b>	¾"	+65°C	1	300	<b>24,10</b>
<b>01-009-0250-010</b>	1"	+65°C	1	300	<b>24,10</b>

**Adapter z króćcem**

Adapter(redukcja) do zbiornika IBC z króćcem na wąż

**(B)** GRUPA RABATOWA

indeks	średnica trzpienia	Tmax	pakowanie		cena netto [zł]
<b>01-009-0140-010</b>	Ø14	+65°C	1	170	<b>31,59</b>



**09 - Kurek z adapterem**

Kurek kulowy czerpalny z adapterem (redukcją) do zbiornika IBC

**(K)** GRUPA RABATOWA

indeks	wielkość	Tmax	pakowanie	cena netto [zł]
<b>01-009-0150-011</b>	1/2"	+65°C	1	<b>49,09</b>
<b>01-009-0200-011</b>	3/4"	+65°C	1	<b>53,41</b>

**Końcówka do kurka PHA-009S**

Końcówka do kurka

**(B)** GRUPA RABATOWA

indeks	wielkość	pakowanie	cena netto [zł]
<b>01-900-0150-001</b>	1/2"	10 1000	<b>3,08</b>

**3110**

Końcówka do węża

**(B)** GRUPA RABATOWA

indeks	wielkość	pakowanie	cena netto [zł]
<b>01-900-0150-000</b>	1/2"	10 1200	<b>2,85</b>
<b>01-900-0200-000</b>	3/4"	10 900	<b>4,60</b>
<b>01-900-0250-000</b>	1"	15 450	<b>6,82</b>

**PHA-304**

Nypel mosiężny wzmocniony

**(K)** GRUPA RABATOWA**PERFEKT<sup>2</sup>SYSTEM**

indeks	wielkość	PN	Tmax	pakowanie	cena netto [zł]
<b>07-004-0100-000</b>	3/8"	16	+180°C	20 500	<b>3,40</b>
<b>07-004-0150-000</b>	1/2"	16	+180°C	20 500	<b>5,31</b>
<b>07-004-0200-000</b>	3/4"	16	+180°C	20 400	<b>8,54</b>
<b>07-004-0250-000</b>	1"	16	+180°C	20 100	<b>15,42</b>
<b>07-004-0320-000</b>	1 1/4"	16	+180°C	10 50	<b>25,59</b>
<b>07-004-0400-000</b>	1 1/2"	16	+180°C	10 50	<b>34,31</b>
<b>07-004-0500-000</b>	2"	16	+180°C	5 50	<b>52,22</b>

**PHA-304/S**

Nypel mosiężny wzmocniony pod uszczelkę płaską

**(K)** GRUPA RABATOWA**PERFEKT<sup>2</sup>SYSTEM**

indeks	wielkość	PN	Tmax	pakowanie	cena netto [zł]
<b>07-004-0150-100</b>	1/2"	16	+180°C	20 400	<b>5,97</b>
<b>07-004-0200-100</b>	3/4"	16	+180°C	20 260	<b>9,30</b>
<b>07-004-0250-100</b>	1"	16	+180°C	10 130	<b>17,00</b>

**PHA-305**

Mufa mosiężna wzmocniona

**(K)** GRUPA RABATOWA**PERFEKT<sup>2</sup>SYSTEM**

indeks	wielkość	PN	Tmax	pakowanie	cena netto [zł]
<b>07-005-0100-000</b>	3/8"	16	+180°C	10 200	<b>3,71</b>
<b>07-005-0150-000</b>	1/2"	16	+180°C	20 400	<b>7,88</b>
<b>07-005-0200-000</b>	3/4"	16	+180°C	20 300	<b>10,94</b>
<b>07-005-0250-000</b>	1"	16	+180°C	10 100	<b>20,54</b>
<b>07-005-0320-000</b>	1 1/4"	16	+180°C	10 50	<b>34,51</b>
<b>07-005-0400-000</b>	1 1/2"	16	+180°C	10 50	<b>37,96</b>
<b>07-005-0500-000</b>	2"	16	+180°C	10 30	<b>49,23</b>



**PHA-306**Redukcja mosiężna  
wzmocniona**(K)** GRUPA RABATOWA**PERFEKT<sup>2</sup>**<sub>SYSTEM</sub>

indeks	wielkość	PN	Tmax	pakowanie	cena netto [zł]
<b>07-006-1510-000</b>	½" x ¾"	16	+180°C	20 500	<b>3,27</b>
<b>07-006-2015-000</b>	¾" x ½"	16	+180°C	20 800	<b>5,27</b>
<b>07-006-2515-000</b>	1" x ½"	16	+180°C	20 400	<b>11,77</b>
<b>07-006-2520-000</b>	1" x ¾"	16	+180°C	20 400	<b>9,40</b>
<b>07-006-3220-000</b>	1¼" x ¾"	16	+180°C	10 200	<b>21,98</b>
<b>07-006-3225-000</b>	1¼" x 1"	16	+180°C	10 200	<b>17,01</b>
<b>07-006-4025-000</b>	1½" x 1"	16	+180°C	10 100	<b>32,13</b>
<b>07-006-4032-000</b>	1½" x 1¼"	16	+180°C	10 100	<b>19,33</b>
<b>07-006-5025-000</b>	2" x 1"	16	+180°C	10 50	<b>57,35</b>
<b>07-006-5032-000</b>	2" x 1¼"	16	+180°C	10 50	<b>51,84</b>
<b>07-006-5040-000</b>	2" x 1½"	16	+180°C	10 50	<b>48,83</b>

**PHA-307**Nypel redukcyjny mosiężny  
wzmocniony**(K)** GRUPA RABATOWA**PERFEKT<sup>2</sup>**<sub>SYSTEM</sub>

indeks	wielkość	PN	Tmax	pakowanie	cena netto [zł]
<b>07-007-1510-000</b>	½" x ¾"	16	+180°C	20 500	<b>5,15</b>
<b>07-007-2015-000</b>	¾" x ½"	16	+180°C	20 400	<b>8,37</b>
<b>07-007-2515-000</b>	1" x ½"	16	+180°C	20 200	<b>14,53</b>
<b>07-007-2520-000</b>	1" x ¾"	16	+180°C	20 200	<b>15,16</b>
<b>07-007-3225-000</b>	1¼" x 1"	16	+180°C	10 150	<b>25,85</b>
<b>07-007-4025-000</b>	1½" x 1"	16	+180°C	10 150	<b>35,26</b>
<b>07-007-5025-000</b>	2" x 1"	16	+180°C	10 100	<b>56,45</b>
<b>07-007-5032-000</b>	2" x 1¼"	16	+180°C	10 100	<b>57,56</b>
<b>07-007-5040-000</b>	2" x 1½"	16	+180°C	10 100	<b>55,55</b>

**PHA-308**Redukcja mufowo-nypłowa  
mosiężna wzmocniona**(K)** GRUPA RABATOWA**PERFEKT<sup>2</sup>**<sub>SYSTEM</sub>

indeks	wielkość	PN	Tmax	pakowanie	cena netto [zł]
<b>07-008-1510-000</b>	½" x ¾"	16	+180°C	20 200	<b>5,74</b>
<b>07-008-2015-000</b>	¾" x ½"	16	+180°C	20 400	<b>8,69</b>
<b>07-008-2520-000</b>	1" x ¾"	16	+180°C	10 200	<b>14,64</b>

**PHA-309**Mufa redukcyjna mosiężna  
wzmocniona**(K)** GRUPA RABATOWA**PERFEKT<sup>2</sup>**<sub>SYSTEM</sub>

indeks	wielkość	PN	Tmax	pakowanie	cena netto [zł]
<b>07-009-1510-000</b>	½" x ¾"	16	+180°C	20 200	<b>5,19</b>
<b>07-009-2015-000</b>	¾" x ½"	16	+180°C	20 400	<b>8,62</b>
<b>07-009-2520-000</b>	1" x ¾"	16	+180°C	10 200	<b>16,72</b>

**PHA-310**Kolano mosiężne  
wzmocnione**(K)** GRUPA RABATOWA**PERFEKT<sup>2</sup>**<sub>SYSTEM</sub>

indeks	wielkość	PN	Tmax	pakowanie	cena netto [zł]
<b>07-010-0100-000</b>	¾"	16	+180°C	20 400	<b>6,49</b>
<b>07-010-0150-000</b>	½"	16	+180°C	20 200	<b>9,60</b>
<b>07-010-0200-000</b>	¾"	16	+180°C	20 200	<b>14,85</b>
<b>07-010-0250-000</b>	1"	16	+180°C	20 100	<b>30,81</b>
<b>07-010-0320-000</b>	1¼"	16	+180°C	10 50	<b>46,32</b>
<b>07-010-0400-000</b>	1½"	16	+180°C	10 50	<b>69,69</b>
<b>07-010-0500-000</b>	2"	16	+180°C	10 50	<b>98,60</b>

## PHA-311

Kolano mosiężne  
wzmocnione WZ**(K)** GRUPA RABATOWAPERFEKT<sup>SYSTEM</sup>

indeks	wielkość	PN	Tmax	pakowanie		cena netto [zł]
<b>07-011-0100-000</b>	3/8"	16	+180°C	10	200	<b>6,41</b>
<b>07-011-0150-000</b>	1/2"	16	+180°C	20	400	<b>9,43</b>
<b>07-011-0200-000</b>	3/4"	16	+180°C	20	300	<b>15,74</b>
<b>07-011-0250-000</b>	1"	16	+180°C	20	200	<b>29,30</b>
<b>07-011-0320-000</b>	1 1/4"	16	+180°C	10	50	<b>48,28</b>
<b>07-011-0400-000</b>	1 1/2"	16	+180°C	10	50	<b>68,57</b>
<b>07-011-0500-000</b>	2"	16	+180°C	10	50	<b>100,14</b>

## PHA-312

Trójnik mosiężny  
wzmocniony**(K)** GRUPA RABATOWAPERFEKT<sup>SYSTEM</sup>

indeks	wielkość	PN	Tmax	pakowanie		cena netto [zł]
<b>07-012-0100-000</b>	3/8"	16	+180°C	10	100	<b>7,94</b>
<b>07-012-0150-000</b>	1/2"	16	+180°C	20	200	<b>11,67</b>
<b>07-012-0200-000</b>	3/4"	16	+180°C	20	200	<b>19,61</b>
<b>07-012-0250-000</b>	1"	16	+180°C	20	100	<b>39,87</b>
<b>07-012-0320-000</b>	1 1/4"	16	+180°C	10	50	<b>56,57</b>
<b>07-012-0400-000</b>	1 1/2"	16	+180°C	10	50	<b>85,88</b>
<b>07-012-0500-000</b>	2"	16	+180°C	10	50	<b>122,39</b>

## PHA-313

Trójnik mosiężny  
wzmocniony WZ**(K)** GRUPA RABATOWAPERFEKT<sup>SYSTEM</sup>

indeks	wielkość	PN	Tmax	pakowanie		cena netto [zł]
<b>07-013-0100-000</b>	3/8"	16	+180°C	10	100	<b>6,58</b>
<b>07-013-0150-000</b>	1/2"	16	+180°C	10	100	<b>11,37</b>
<b>07-013-0200-000</b>	3/4"	16	+180°C	10	100	<b>18,54</b>
<b>07-013-0250-000</b>	1"	16	+180°C	10	100	<b>38,13</b>

## PHA-314

Trójnik redukcyjny  
mosiężny wzmocniony**(K)** GRUPA RABATOWAPERFEKT<sup>SYSTEM</sup>

indeks	wielkość	PN	Tmax	pakowanie		cena netto [zł]
<b>07-014-2015-000</b>	3/4" x 1/2"	16	+180°C	10	100	<b>19,33</b>
<b>07-014-2515-000</b>	1" x 1/2"	16	+180°C	10	100	<b>33,54</b>
<b>07-014-2520-000</b>	1" x 3/4"	16	+180°C	10	100	<b>36,52</b>

## PHA-315

Przedłużka mosiężna  
wzmocniona WZ**(K)** GRUPA RABATOWAPERFEKT<sup>SYSTEM</sup>

indeks	wielkość	PN	Tmax	pakowanie		cena netto [zł]
<b>07-015-1015-000</b>	1/2" x 10	16	+180°C	20	540	<b>6,83</b>
<b>07-015-1515-000</b>	1/2" x 15	16	+180°C	20	540	<b>8,21</b>
<b>07-015-2015-000</b>	1/2" x 20	16	+180°C	20	320	<b>10,09</b>
<b>07-015-2515-000</b>	1/2" x 25	16	+180°C	20	320	<b>11,86</b>
<b>07-015-3015-000</b>	1/2" x 30	16	+180°C	20	320	<b>13,52</b>
<b>07-015-4015-000</b>	1/2" x 40	16	+180°C	20	320	<b>17,62</b>
<b>07-015-5015-000</b>	1/2" x 50	16	+180°C	20	240	<b>21,78</b>

## PHA-316

korek wzmocniony



K

GRUPA RABATOWA

PERFEKT<sup>SYSTEM</sup>

indeks	wielkość	PN	Tmax	pakowanie		cena netto [zł]
<b>07-016-0320-000</b>	1¼"	16	+120°C	10	180	<b>17,70</b>
<b>07-016-0400-000</b>	1½"	16	+120°C	5	180	<b>20,95</b>

## PHA-318

Trójnik wzmocniony pod odpowietrznik



K

GRUPA RABATOWA

PERFEKT<sup>SYSTEM</sup>

indeks	wielkość	PN	Tmax	pakowanie		cena netto [zł]
<b>07-018-2515-000</b>	1 x 1 x ½"	16	+120°C	5	60	<b>33,10</b>

## PHA-300

Śrubunek prosty o-ring mosiężny wzmocniony



K

GRUPA RABATOWA

PERFEKT<sup>SYSTEM</sup>

indeks	wielkość	PN	Tmax	pakowanie		cena netto [zł]
<b>07-000-0150-000</b>	½" L-55mm	16	+120°C	20	200	<b>19,16</b>
<b>07-000-0200-000</b>	¾" L-60mm	16	+120°C	12	120	<b>30,45</b>
<b>07-000-0250-000</b>	1" L-65mm	16	+120°C	8	80	<b>55,29</b>

## PHA-301

Śrubunek prosty stożek mosiężny wzmocniony



K

GRUPA RABATOWA

PERFEKT<sup>SYSTEM</sup>

indeks	wielkość	PN	Tmax	pakowanie		cena netto [zł]
<b>07-001-0150-000</b>	½" L-55mm	16	+120°C	20	200	<b>19,51</b>
<b>07-001-0200-000</b>	¾" L-60mm	16	+120°C	12	120	<b>30,45</b>
<b>07-001-0250-000</b>	1" L-65mm	16	+120°C	8	80	<b>55,29</b>

## 502G

Przedłużka mosiężna WZ



D

GRUPA RABATOWA



indeks	wielkość	PN	Tmax	pakowanie		cena netto [zł]
<b>07-220-1510-000</b>	½" x 10	16	+180°C	20	540	<b>4,59</b>
<b>07-220-1515-000</b>	½" x 15	16	+180°C	20	540	<b>5,51</b>
<b>07-220-1520-000</b>	½" x 20	16	+180°C	20	320	<b>6,82</b>
<b>07-220-1525-000</b>	½" x 25	16	+180°C	20	320	<b>8,01</b>
<b>07-220-1530-000</b>	½" x 30	16	+180°C	20	320	<b>9,31</b>
<b>07-220-1540-000</b>	½" x 40	16	+180°C	20	320	<b>10,72</b>
<b>07-220-1550-000</b>	½" x 50	16	+180°C	20	240	<b>14,06</b>
<b>07-220-1560-000</b>	½" x 60	16	+180°C	20	160	<b>17,26</b>
<b>07-220-1580-000</b>	½" x 80	16	+180°C	20	160	<b>21,65</b>
<b>07-220-1599-000</b>	½" x 100	16	+180°C	20	120	<b>26,37</b>
<b>07-220-2010-000</b>	¾" x 10	16	+180°C	10	550	<b>6,43</b>
<b>07-220-2015-000</b>	¾" x 15	16	+180°C	20	320	<b>7,95</b>
<b>07-220-2020-000</b>	¾" x 20	16	+180°C	20	320	<b>9,30</b>
<b>07-220-2030-000</b>	¾" x 30	16	+180°C	10	260	<b>12,77</b>
<b>07-220-2040-000</b>	¾" x 40	16	+180°C	20	180	<b>15,67</b>
<b>07-220-2050-000</b>	¾" x 50	16	+180°C	20	180	<b>18,10</b>

## 5101

Korek mosiężny GZ



**D** GRUPA RABATOWA

indeks	wielkość	PN	Tmax	pakowanie	cena netto [zł]
<b>07-201-0100-000</b>	3/8"	16	+180°C	50 1000	<b>3,84</b>
<b>07-201-0150-000</b>	1/2"	16	+180°C	50 1000	<b>3,58</b>
<b>07-201-0200-000</b>	3/4"	16	+180°C	50 500	<b>5,85</b>
<b>07-201-0250-000</b>	1"	16	+180°C	5 250	<b>10,54</b>

## 5102

Zaślepka mosiężna GW



**D** GRUPA RABATOWA

indeks	wielkość	PN	Tmax	pakowanie	cena netto [zł]
<b>07-202-0100-000</b>	3/8"	16	+180°C	50 800	<b>3,84</b>
<b>07-202-0150-000</b>	1/2"	16	+180°C	50 800	<b>3,58</b>
<b>07-202-0200-000</b>	3/4"	16	+180°C	130 520	<b>5,85</b>
<b>07-202-0250-000</b>	1"	16	+180°C	50 400	<b>12,78</b>
<b>07-202-0320-000</b>	1 1/4"	16	+180°C	1 1	<b>17,01</b>

## 5105

Nypel mosiężny



**D** GRUPA RABATOWA

indeks	wielkość	PN	Tmax	pakowanie	cena netto [zł]
<b>07-205-0100-000</b>	3/8"	16	+180°C	100 1200	<b>2,79</b>
<b>07-205-0150-000</b>	1/2"	16	+180°C	100 600	<b>4,23</b>
<b>07-205-0200-000</b>	3/4"	16	+180°C	50 400	<b>7,51</b>
<b>07-205-0250-000</b>	1"	16	+180°C	20 160	<b>13,79</b>
<b>07-205-0320-000</b>	1 1/4"	16	+180°C	10 120	<b>18,34</b>

## 5108

Mufa mosiężna



**D** GRUPA RABATOWA

indeks	wielkość	PN	Tmax	pakowanie	cena netto [zł]
<b>07-208-0150-000</b>	1/2"	16	+180°C	100 600	<b>6,32</b>
<b>07-208-0200-000</b>	3/4"	16	+180°C	50 400	<b>8,79</b>
<b>07-208-0250-000</b>	1"	16	+180°C	20 240	<b>15,18</b>
<b>07-208-0320-000</b>	1 1/4"	16	+180°C	10 120	<b>24,56</b>

## 5109

Nypel redukcyjny mosiężny



**D** GRUPA RABATOWA

indeks	wielkość	PN	Tmax	pakowanie	cena netto [zł]
<b>07-209-1510-000</b>	3/8" x 1/2"	16	+180°C	100 800	<b>4,03</b>
<b>07-209-1520-000</b>	1/2" x 3/4"	16	+180°C	50 400	<b>6,27</b>
<b>07-209-2025-000</b>	3/4" x 1"	16	+180°C	50 300	<b>11,36</b>

## 5110

Redukcja mosiężna



**D** GRUPA RABATOWA

indeks	wielkość	PN	Tmax	pakowanie	cena netto [zł]
<b>07-210-1008-000</b>	3/8" x 1/4"	16	+180°C	100 1200	<b>3,36</b>
<b>07-210-1508-000</b>	1/2" x 1/4"	16	+180°C	50 500	<b>4,42</b>
<b>07-210-1510-000</b>	1/2" x 3/8"	16	+180°C	100 1200	<b>2,53</b>
<b>07-210-1525-000</b>	1/2" x 1"	16	+180°C	50 400	<b>9,82</b>
<b>07-210-2015-000</b>	3/4" x 1/2"	16	+180°C	50 600	<b>4,46</b>
<b>07-210-2025-000</b>	3/4" x 1"	16	+180°C	50 400	<b>7,09</b>
<b>07-210-2532-000</b>	1" x 1 1/4"	16	+180°C	20 160	<b>16,26</b>

## 5111

Redukcja mufowo-nyplowa mosiężna



**D** GRUPA RABATOWA

indeks	wielkość	PN	Tmax	pakowanie	cena netto [zł]
<b>07-211-1510-000</b>	3/8" x 1/2"	16	+180°C	50 800	<b>4,49</b>
<b>07-211-1525-000</b>	1/2" x 1"	16	+180°C	50 200	<b>11,17</b>
<b>07-211-2015-000</b>	1/2" x 3/4"	16	+180°C	50 400	<b>6,46</b>
<b>07-211-2025-000</b>	3/4" x 1"	16	+180°C	50 200	<b>10,91</b>
<b>07-211-3225-000</b>	1" x 1 1/4"	16	+180°C	50 150	<b>19,91</b>

## 5112

Mufa redukcyjna  
mosiężna

indeks	wielkość	PN	Tmax	pakowanie		cena netto [zł]
<b>07-212-1510-000</b>	3/8" x 1/2"	16	+180°C	50	500	<b>4,77</b>
<b>07-212-2015-000</b>	1/2" x 3/4"	16	+180°C	50	400	<b>6,82</b>
<b>07-212-2515-000</b>	1/2" x 1"	16	+180°C	50	200	<b>10,96</b>
<b>07-212-2520-000</b>	3/4" x 1"	16	+180°C	50	200	<b>12,08</b>

D GRUPA RABATOWA



## 5113

Kolano mosiężne



indeks	wielkość	PN	Tmax	pakowanie		cena netto [zł]
<b>07-213-0100-000</b>	3/8"	16	+180°C	60	600	<b>5,29</b>
<b>07-213-0150-000</b>	1/2"	16	+180°C	50	500	<b>8,91</b>
<b>07-213-0200-000</b>	3/4"	16	+180°C	50	200	<b>13,79</b>
<b>07-213-0250-000</b>	1"	16	+180°C	20	120	<b>24,94</b>

D GRUPA RABATOWA



## 5114

Kolano mosiężne WZ



indeks	wielkość	PN	Tmax	pakowanie		cena netto [zł]
<b>07-214-0100-000</b>	3/8"	16	+180°C	60	600	<b>5,29</b>
<b>07-214-0150-000</b>	1/2"	16	+180°C	10	220	<b>8,98</b>
<b>07-214-0200-000</b>	3/4"	16	+180°C	50	200	<b>14,75</b>
<b>07-214-0250-000</b>	1"	16	+180°C	20	120	<b>26,93</b>

D GRUPA RABATOWA



## 5115

Kolano mosiężne  
redukcyjne WZ

indeks	wielkość	PN	Tmax	pakowanie		cena netto [zł]
<b>07-215-2015-000</b>	3/4" x 1/2"	16	+180°C	10	150	<b>12,42</b>
<b>07-215-2520-000</b>	1" x 3/4"	16	+180°C	10	100	<b>20,16</b>

D GRUPA RABATOWA



## 5116

Trójnik mosiężny



indeks	wielkość	PN	Tmax	pakowanie		cena netto [zł]
<b>07-216-0150-000</b>	1/2"	16	+180°C	10	180	<b>11,30</b>
<b>07-216-0200-000</b>	3/4"	16	+180°C	10	90	<b>17,89</b>
<b>07-216-0250-000</b>	1"	16	+180°C	5	50	<b>33,05</b>

D GRUPA RABATOWA



<b>07-216-1510-000</b>	1/2" x M10	16	+180°C	50	300	<b>19,83</b>
------------------------	------------	----	--------	----	-----	--------------



## 5118

Kolano mosiężne  
z mocowaniem WW

indeks	wielkość	PN	Tmax	pakowanie		cena netto [zł]
<b>07-218-0150-000</b>	1/2"	16	+180°C	10	150	<b>12,27</b>

D GRUPA RABATOWA



## 5119

Listwa montażowa  
pod baterię

indeks	wielkość	PN	Tmax	pakowanie		cena netto [zł]
<b>07-221-0100-000</b>	15 x 1/2 x 100	16	+110°C	1	60	<b>23,12</b>
<b>07-221-0150-000</b>	15 x 1/2 x 150	16	+110°C	1	20	<b>23,51</b>

D GRUPA RABATOWA



## 1046

Śrubunek prosty o-ring mosiężny



indeks	wielkość	PN	Tmax	pakowanie		cena netto [zł]
<b>07-146-0100-000</b>	3/8"	16	+120°C	20	200	<b>10,40</b>
<b>07-146-0150-000</b>	1/2"	16	+120°C	18	270	<b>13,32</b>
<b>07-146-0200-000</b>	3/4"	16	+120°C	10	140	<b>21,86</b>
<b>07-146-0250-000</b>	1"	16	+120°C	8	80	<b>40,21</b>
<b>07-146-0320-000</b>	1 1/4"	16	+120°C	10	40	<b>59,17</b>
<b>07-146-0400-000</b>	1 1/2"	16	+120°C	2	20	<b>102,83</b>
<b>07-146-0500-000</b>	2"	16	+120°C	2	20	<b>170,05</b>

B GRUPA RABATOWA

## 1046S

Śrubunek prosty o-ring mosiężny



indeks	wielkość	PN	Tmax	pakowanie		cena netto [zł]
<b>07-146-0150-002</b>	1/2"	16	+120°C	18	270	<b>13,58</b>
<b>07-146-0200-002</b>	3/4"	16	+120°C	10	120	<b>22,34</b>
<b>07-146-0250-002</b>	1"	16	+120°C	8	80	<b>41,59</b>

B GRUPA RABATOWA

## 1046A

Śrubunek prosty o-ring z gwintem samouszczel. mosiężny



indeks	wielkość	PN	Tmax	pakowanie		cena netto [zł]
<b>07-146-0150-001</b>	1/2"	16	+120°C	20	200	<b>14,65</b>
<b>07-146-0200-001</b>	3/4"	16	+120°C	18	270	<b>22,85</b>
<b>07-146-0250-001</b>	1"	16	+120°C	10	140	<b>41,61</b>

B GRUPA RABATOWA

Produkt dostępny do wyczerpania zapasów

## 1047

Śrubunek prosty stożek mosiężny



indeks	wielkość	PN	Tmax	pakowanie		cena netto [zł]
<b>07-147-0100-000</b>	3/8"	16	+120°C	20	200	<b>10,40</b>
<b>07-147-0150-000</b>	1/2"	16	+120°C	18	270	<b>13,32</b>
<b>07-147-0200-000</b>	3/4"	16	+120°C	10	140	<b>21,86</b>
<b>07-147-0250-000</b>	1"	16	+120°C	8	80	<b>40,21</b>
<b>07-147-0320-000</b>	1 1/4"	16	+120°C	10	40	<b>59,17</b>
<b>07-147-0400-000</b>	1 1/2"	16	+120°C	5	25	<b>102,83</b>
<b>07-147-0500-000</b>	2"	16	+120°C	2	12	<b>170,05</b>

B GRUPA RABATOWA

## 1048

Śrubunek kątowy o-ring mosiężny



indeks	wielkość	PN	Tmax	pakowanie		cena netto [zł]
<b>07-148-0100-000</b>	3/8"	16	+120°C	20	200	<b>11,66</b>
<b>07-148-0150-000</b>	1/2"	16	+120°C	15	150	<b>19,54</b>
<b>07-148-0200-000</b>	3/4"	16	+120°C	10	60	<b>30,22</b>
<b>07-148-0250-000</b>	1"	16	+120°C	10	60	<b>51,93</b>
<b>07-148-0320-000</b>	1 1/4"	16	+120°C	10	40	<b>84,97</b>

B GRUPA RABATOWA

## 1049

Śrubunek kątowy stożek mosiężny



indeks	wielkość	PN	Tmax	pakowanie		cena netto [zł]
<b>07-149-0150-000</b>	1/2"	16	+120°C	15	180	<b>19,54</b>
<b>07-149-0200-000</b>	3/4"	16	+120°C	10	100	<b>30,22</b>
<b>07-149-0250-000</b>	1"	16	+120°C	10	60	<b>51,93</b>

B GRUPA RABATOWA

## 5120

Śrubunek wodomierza mosiężny



indeks	wielkość	PN	Tmax	pakowanie		cena netto [zł]
<b>07-190-0150-000</b>	1/2"	16	+90°C	30	150	<b>11,51</b>
<b>07-190-0200-000</b>	3/4"	16	+90°C	20	200	<b>16,20</b>
<b>07-190-0250-000</b>	1"	16	+90°C	10	100	<b>31,84</b>

D GRUPA RABATOWA

**5120S**

Śrubunek wodomierza mosiężny



indeks	wielkość	PN	Tmax	pakowanie		cena netto [zł]
<b>07-190-0151-000</b>	½" L-36 mm	16	+90°C	2	200	<b>9,61</b>

**D** GRUPA RABATOWA**5122**

Śrubunek prosty z obrotową nakrętką



indeks	wielkość	PN	Tmax	pakowanie		cena netto [zł]
<b>07-150-0150-000</b>	½"	16	+90°C	1	200	<b>9,65</b>
<b>07-150-0200-000</b>	¾"	16	+90°C	1	150	<b>14,16</b>
<b>07-150-0250-000</b>	1"	16	+90°C	5	100	<b>22,63</b>

**B** GRUPA RABATOWA**U51**

Uszczelka płaska fibrowa do śrubunków wodomierza 5120 i 5120S



indeks	wielkość	pakowanie		cena netto [zł]
<b>28-001-0150-000</b>	½"	1	luz	<b>0,33</b>
<b>28-001-0200-000</b>	¾"	1	luz	<b>0,37</b>
<b>28-001-0250-000</b>	1"	1	luz	<b>0,44</b>

**D** GRUPA RABATOWA**5000**

Konsola wodomierza ze stali węglowej z powłoką malarską



indeks	wielkość	PN	Tmax	pakowanie		cena netto [zł]
<b>07-195-0150-000</b>	½"	16	+90°C	1	10	<b>128,36</b>
<b>07-195-0200-000</b>	¾"	16	+90°C	1	10	<b>157,94</b>

**D** GRUPA RABATOWA**5000N**

Konsola wodomierza ze stali nierdzewnej



indeks	wielkość	PN	Tmax	pakowanie		cena netto [zł]
<b>07-195-0150-001</b>	½"	16	+90°C	1	10	<b>166,87</b>
<b>07-195-0200-001</b>	¾"	16	+90°C	1	10	<b>196,43</b>

**D** GRUPA RABATOWA**5000N/A**

Konsola wodomierza ze stali nierdzewnej



indeks	wielkość	PN	Tmax	pakowanie		cena netto [zł]
<b>07-195-0200-002</b>	¾"	16	+90°C	1	10	<b>196,43</b>

**D** GRUPA RABATOWA**U46**

Uszczelka do śrubunków samuszczelniających 1046A



indeks	wielkość	pakowanie		cena netto [zł]
<b>28-000-0150-000</b>	½"	1	luz	<b>0,33</b>
<b>28-000-0200-000</b>	¾"	1	luz	<b>0,35</b>
<b>28-000-0250-000</b>	1"	1	luz	<b>0,58</b>

**B** GRUPA RABATOWA**U60**

Pierścień uszczelniający do śrubunków 1046 i 1046S oraz 1048



indeks	wielkość	pakowanie		cena netto [zł]
<b>28-002-0010-000</b>	¾"	1	luz	<b>0,22</b>
<b>28-002-0150-000</b>	½"	1	luz	<b>0,27</b>
<b>28-002-0200-000</b>	¾"	1	luz	<b>0,31</b>
<b>28-002-0250-000</b>	1"	1	luz	<b>0,33</b>

**B** GRUPA RABATOWA

## 502

Przedłużka mosiężna chromowana WZ



indeks	wielkość	PN	Tmax	pakowanie	cena netto [zł]
<b>07-521-1510-000</b>	1/2" x 10	16	+180°C	20 540	<b>5,21</b>
<b>07-521-1515-000</b>	1/2" x 15	16	+180°C	20 540	<b>6,23</b>
<b>07-521-1520-000</b>	1/2" x 20	16	+180°C	20 320	<b>7,24</b>
<b>07-521-1525-000</b>	1/2" x 25	16	+180°C	20 320	<b>8,78</b>
<b>07-521-1530-000</b>	1/2" x 30	16	+180°C	20 320	<b>10,01</b>
<b>07-521-1540-000</b>	1/2" x 40	16	+180°C	20 320	<b>12,77</b>
<b>07-521-1550-000</b>	1/2" x 50	16	+180°C	20 240	<b>15,55</b>
<b>07-521-1560-000</b>	1/2" x 60	16	+180°C	20 160	<b>18,68</b>
<b>07-521-1580-000</b>	1/2" x 80	16	+180°C	20 160	<b>24,12</b>
<b>07-521-1599-000</b>	1/2" x 100	16	+180°C	20 120	<b>30,03</b>
<b>07-521-2010-000</b>	3/4" x 10	16	+180°C	20 320	<b>8,40</b>
<b>07-521-2020-000</b>	3/4" x 20	16	+180°C	20 320	<b>12,75</b>
<b>07-521-2030-000</b>	3/4" x 30	16	+180°C	20 320	<b>16,95</b>
<b>07-521-2040-000</b>	3/4" x 40	16	+180°C	20 180	<b>21,32</b>
<b>07-521-2050-000</b>	3/4" x 50	16	+180°C	20 180	<b>24,90</b>

D GRUPA RABATOWA

## 520

Nypel mosiężny chromowany



indeks	wielkość	PN	Tmax	pakowanie	cena netto [zł]
<b>07-520-0100-000</b>	3/8"	16	+180°C	20 1000	<b>3,44</b>
<b>07-520-0150-000</b>	1/2"	16	+180°C	20 1000	<b>5,08</b>
<b>07-520-0200-000</b>	3/4"	16	+180°C	20 240	<b>7,89</b>

D GRUPA RABATOWA

## 454

Mufa mosiężna chromowana



indeks	wielkość	PN	Tmax	pakowanie	cena netto [zł]
<b>07-454-0100-000</b>	3/8"	16	+180°C	20 600	<b>6,35</b>
<b>07-454-0150-000</b>	1/2"	16	+180°C	20 240	<b>7,66</b>
<b>07-454-0200-000</b>	3/4"	16	+180°C	20 240	<b>11,73</b>

D GRUPA RABATOWA

## 511

Redukcja mosiężna chromowana



indeks	wielkość	PN	Tmax	pakowanie	cena netto [zł]
<b>07-511-1015-000</b>	3/8" x 1/2"	16	+180°C	20 1000	<b>2,98</b>
<b>07-511-1520-000</b>	1/2" x 3/4"	16	+180°C	20 600	<b>5,26</b>

D GRUPA RABATOWA

## 512

Redukcja mosiężna chromowana z uszczelką



indeks	wielkość	PN	Tmax	pakowanie	cena netto [zł]
<b>07-512-1015-000</b>	3/8" x 1/2"	16	+180°C	50 800	<b>4,22</b>

D GRUPA RABATOWA

## 515

Nypel redukcyjny mosiężny chromowany



indeks	wielkość	PN	Tmax	pakowanie	cena netto [zł]
<b>07-515-1015-000</b>	3/8" x 1/2"	16	+180°C	20 320	<b>4,41</b>
<b>07-515-1520-000</b>	1/2" x 3/4"	16	+180°C	20 240	<b>7,36</b>

D GRUPA RABATOWA

## 506

Redukcja mufowo-nypłowa mosiężna chromowana



indeks	wielkość	PN	Tmax	pakowanie	cena netto [zł]
<b>07-506-1015-000</b>	3/8" x 1/2"	16	+180°C	20 800	<b>5,48</b>
<b>07-506-1520-000</b>	1/2" x 3/4"	16	+180°C	20 480	<b>8,50</b>

D GRUPA RABATOWA



**510**Redukcja mufowa  
mosiężna chromowana

indeks	wielkość	PN	Tmax	pakowanie	cena netto [zł]
<b>07-510-1015-000</b>	3/8" x 1/2"	16	+180°C	20 280	<b>6,59</b>
<b>07-510-1520-000</b>	1/2" x 3/4"	16	+180°C	20 480	<b>9,61</b>

**D** GRUPA RABATOWA**451**Kolano mosiężne  
chromowane WZ

indeks	wielkość	PN	Tmax	pakowanie	cena netto [zł]
<b>07-451-0100-000</b>	3/8"	16	+180°C	20 320	<b>8,09</b>
<b>07-451-0150-000</b>	1/2"	16	+180°C	20 360	<b>10,83</b>
<b>07-451-0200-000</b>	3/4"	16	+180°C	20 200	<b>17,86</b>

**D** GRUPA RABATOWA**452**Kolano mosiężne  
chromowane WW

indeks	wielkość	PN	Tmax	pakowanie	cena netto [zł]
<b>07-452-0100-000</b>	3/8"	16	+180°C	20 360	<b>8,13</b>
<b>07-452-0150-000</b>	1/2"	16	+180°C	20 480	<b>10,35</b>
<b>07-452-0200-000</b>	3/4"	16	+180°C	20 240	<b>17,69</b>

**D** GRUPA RABATOWA**453**Trójnik mosiężny  
chromowany

indeks	wielkość	PN	Tmax	pakowanie	cena netto [zł]
<b>07-453-0100-000</b>	3/8"	16	+180°C	20 480	<b>8,68</b>
<b>07-453-0150-000</b>	1/2"	16	+180°C	20 480	<b>12,38</b>
<b>07-453-0200-000</b>	3/4"	16	+180°C	20 280	<b>18,92</b>

**D** GRUPA RABATOWA**453WWZ**Trójnik mosiężny  
chromowany WWZ

indeks	wielkość	PN	Tmax	pakowanie	cena netto [zł]
<b>07-453-0150-001</b>	1/2"	16	+180°C	20 480	<b>17,78</b>

**D** GRUPA RABATOWA**1046CH**Śrubunek prosty o-ring  
mosiężny chromowany

indeks	wielkość	PN	Tmax	pakowanie	cena netto [zł]
<b>07-450-0100-000</b>	3/8"	16	+120°C	20 200	<b>11,40</b>
<b>07-450-0150-000</b>	1/2"	16	+120°C	18 280	<b>15,03</b>

**D** GRUPA RABATOWA**1048CH**Śrubunek kątowy o-ring  
mosiężny chromowany

indeks	wielkość	PN	Tmax	pakowanie	cena netto [zł]
<b>07-449-0150-000</b>	1/2"	16	+120°C	18 180	<b>15,24</b>
<b>07-449-0200-000</b>	3/4"	16	+120°C	10 100	<b>24,58</b>

**D** GRUPA RABATOWA**5101CH**Korek mosiężny  
chromowany GZ

indeks	wielkość	PN	Tmax	pakowanie	cena netto [zł]
<b>07-456-0150-000</b>	1/2"	16	+180°C	50 1000	<b>3,94</b>
<b>07-456-0200-000</b>	3/4"	16	+180°C	50 500	<b>6,32</b>

**D** GRUPA RABATOWA

**5102CH**

Zaślepka mosiężna chromowana



indeks	wielkość	PN	Tmax	pakowanie	cena netto [zł]
<b>07-457-0150-000</b>	1/2"	16	+180°C	50 800	<b>4,30</b>
<b>07-457-0200-000</b>	3/4"	16	+180°C	130 520	<b>6,18</b>

**D** GRUPA RABATOWA**PHA-351**

Przedłużka pod baterię naścienną mosiężna chromowana WZ



indeks	wielkość	PN	Tmax	pakowanie	cena netto [zł]
<b>07-351-0200-000</b>	3/4"	16	+180°C	20 180	<b>17,71</b>

**D** GRUPA RABATOWA**PHA-352**

Trójnik typu "Y" mosiężny chromowany WZ



indeks	wielkość	PN	Tmax	pakowanie	cena netto [zł]
<b>07-352-0150-000</b>	1/2"	16	+180°C	20 200	<b>20,44</b>

**D** GRUPA RABATOWA**TT**

Taśma teflonowa



indeks	wielkość	kolor taśmy	pakowanie	cena netto [zł]
<b>29-002-0000-000</b>	0,2 mm x 12 mm x 15 mb	niebieska	5 50	<b>11,42</b>
<b>29-003-0000-000</b>	0,2 mm x 19 mm x 15 mb	żółta	5 50	<b>10,37</b>
<b>29-004-0000-000</b>	0,2 mm x 25 mm x 15 mb	czerwona	5 50	<b>13,90</b>
<b>29-001-0002-000</b>	0,075 mm x 12mm x 10 mb	biała	10 250	<b>1,85</b>

**E** GRUPA RABATOWA**PHA-011**

Kurek kulowy z filtrem podłączeniowy, metalowe pokrętko



indeks	wielkość	PN	Tmax	pakowanie	cena netto [zł]
<b>02-011-1510-000</b>	1/2" x 3/8"	16	+120°C	1 100	<b>26,43</b>
<b>02-011-1515-000</b>	1/2" x 1/2"	16	+120°C	1 100	<b>26,79</b>
<b>02-011-1520-000</b>	1/2" x 3/4"	16	+120°C	1 100	<b>28,25</b>

**K** GRUPA RABATOWA**PHA-012**

Kurek kulowy z filtrem podłączeniowy krótki, metalowe pokrętko



indeks	wielkość	PN	Tmax	pakowanie	cena netto [zł]
<b>02-012-1510-000</b>	1/2" x 3/8"	16	+120°C	1 100	<b>23,71</b>
<b>02-012-1515-000</b>	1/2" x 1/2"	16	+120°C	1 100	<b>24,09</b>
<b>02-012-1520-000</b>	1/2" x 3/4"	16	+120°C	1 100	<b>25,69</b>

**K** GRUPA RABATOWA**PHA-0140**

Prolunga zawór grzybkowy podłączeniowy z obrotową nakrętką i przedłużką



indeks	wielkość	PN	Tmax	pakowanie	cena netto [zł]
<b>02-014-0200-001</b>	3/4" x 3/4" x 3/4"	10	+90°C	1 150	<b>51,85</b>

**E** GRUPA RABATOWA**PHA-018**

Zawór grzybkowy podłączeniowy



indeks	wielkość	PN	Tmax	pakowanie	cena netto [zł]
<b>02-018-1510-000</b>	1/2" x 3/8"	16	+120°C	20 200	<b>22,02</b>
<b>02-018-1515-000</b>	1/2" x 1/2"	16	+120°C	20 200	<b>22,33</b>
<b>02-018-1520-000</b>	1/2" x 3/4"	16	+120°C	20 200	<b>23,38</b>

**K** GRUPA RABATOWA

**PHA-050**Zawór kombinowany  
podłączeniowyPERFEKT<sup>SYSTEM</sup>

indeks	wielkość	PN	Tmax	pakowanie		cena netto [2]
<b>02-050-1520-000</b>	1/2" x 3/8" x 3/4"	10	+90°C	1	80	<b>54,54</b>

**(K)** GRUPA RABATOWA**PHA-051**Zawór podłączeniowy  
kątowy z ceramiczną  
głowicąPERFEKT<sup>SYSTEM</sup>

indeks	wielkość	PN	Tmax	pakowanie		cena netto [2]
<b>02-051-1510-000</b>	1/2" x 3/8"	10	+90°C	1	100	<b>33,14</b>
<b>02-051-1515-000</b>	1/2" x 1/2"	10	+90°C	1	100	<b>33,43</b>
<b>02-051-1520-000</b>	1/2" x 3/4"	10	+90°C	1	100	<b>34,42</b>

**(K)** GRUPA RABATOWA**PHA-052**Zawór podłączeniowy  
kątowy z ceramiczną  
głowicąPERFEKT<sup>SYSTEM</sup>

indeks	wielkość	PN	Tmax	pakowanie		cena netto [2]
<b>02-052-1510-000</b>	1/2" x 3/8"	10	+90°C	1	100	<b>30,59</b>
<b>02-052-1515-000</b>	1/2" x 1/2"	10	+90°C	1	100	<b>31,22</b>
<b>02-052-1520-000</b>	1/2" x 3/4"	10	+90°C	1	100	<b>32,76</b>

**(K)** GRUPA RABATOWA**PHA-055**Zawór kulowy antykamieny  
podłączeniowy,  
metalowe pokrętkoPERFEKT<sup>SYSTEM</sup>

indeks	wielkość	PN	Tmax	pakowanie		cena netto [2]
<b>02-055-1510-000</b>	1/2" x 3/8"	10	+90°C	1	100	<b>22,64</b>
<b>02-055-1515-000</b>	1/2" x 1/2"	10	+90°C	1	100	<b>23,08</b>
<b>02-055-1520-000</b>	1/2" x 3/4"	10	+90°C	1	100	<b>23,32</b>

**(K)** GRUPA RABATOWA**PHA-056**Zawór grzybkowy z filtrem  
podłączeniowyPERFEKT<sup>SYSTEM</sup>

indeks	wielkość	PN	Tmax	pakowanie		cena netto [2]
<b>02-056-1510-000</b>	1/2" x 3/8"	10	+90°C	1	100	<b>20,58</b>
<b>02-056-1515-000</b>	1/2" x 1/2"	10	+90°C	1	100	<b>20,87</b>

**(K)** GRUPA RABATOWA**3003**Zawór kulowy  
podłączeniowy

indeks	wielkość	PN	Tmax	pakowanie		cena netto [2]
<b>02-200-1510-000</b>	1/2" x 3/8"	16	+120°C	1	100	<b>15,90</b>
<b>02-200-1515-000</b>	1/2" x 1/2"	16	+120°C	1	100	<b>16,39</b>
<b>02-200-1520-000</b>	1/2" x 3/4"	16	+120°C	1	100	<b>16,89</b>

**(B)** GRUPA RABATOWA**3003S**Zawór kulowy  
podłączeniowy krótki

indeks	wielkość	PN	Tmax	pakowanie		cena netto [2]
<b>02-204-1510-000</b>	1/2" x 3/8"	10	+90°C	25	100	<b>14,49</b>

**(B)** GRUPA RABATOWA**3026**Kurek kulowy trójdrogowy  
podłączeniowy

indeks	wielkość	PN	Tmax	pakowanie		cena netto [2]
<b>02-302-1515-000</b>	1/2" x 1/2" x 3/4"	10	+90°C	1	200	<b>23,75</b>

**(E)** GRUPA RABATOWA

## PHA-9105

Przyłącze elastyczne w oplocie ze stali nierdzewnej WZ

**E** GRUPA RABATOWA

PERFEKT<sup>2</sup> SYSTEM

indeks	wielkość	DN	PN	Tmax	pakowanie		cena netto [zł]
<b>06-000-1010-030</b>	3/8" x 3/8" x 30	8	10	+70°C	10	200	<b>11,32</b>
<b>06-000-1010-040</b>	3/8" x 3/8" x 40	8	10	+70°C	10	150	<b>11,70</b>
<b>06-000-1010-050</b>	3/8" x 3/8" x 50	8	10	+70°C	10	100	<b>12,62</b>
<b>06-000-1515-020</b>	1/2" x 1/2" x 20	8	10	+70°C	10	200	<b>11,15</b>
<b>06-000-1515-025</b>	1/2" x 1/2" x 25	8	10	+70°C	10	260	<b>11,52</b>
<b>06-000-1515-030</b>	1/2" x 1/2" x 30	8	10	+70°C	10	200	<b>11,98</b>
<b>06-000-1515-040</b>	1/2" x 1/2" x 40	8	10	+70°C	10	150	<b>12,99</b>
<b>06-000-1515-045</b>	1/2" x 1/2" x 45	8	10	+70°C	10	150	<b>13,52</b>
<b>06-000-1515-050</b>	1/2" x 1/2" x 50	8	10	+70°C	10	150	<b>14,10</b>
<b>06-000-1515-060</b>	1/2" x 1/2" x 60	8	10	+70°C	10	100	<b>15,10</b>
<b>06-000-1515-070</b>	1/2" x 1/2" x 70	8	10	+70°C	10	100	<b>16,89</b>
<b>06-000-1515-080</b>	1/2" x 1/2" x 80	8	10	+70°C	10	100	<b>17,75</b>
<b>06-000-1515-090</b>	1/2" x 1/2" x 90	8	10	+70°C	10	90	<b>19,55</b>
<b>06-000-1515-100</b>	1/2" x 1/2" x 100	8	10	+70°C	10	100	<b>20,66</b>
<b>06-000-1515-120</b>	1/2" x 1/2" x 120	8	10	+70°C	10	70	<b>21,92</b>
<b>06-000-1515-150</b>	1/2" x 1/2" x 150	8	10	+70°C	10	50	<b>24,85</b>

## PHA-9110

Przyłącze elastyczne w oplocie ze stali nierdzewnej WW

**E** GRUPA RABATOWA

PERFEKT<sup>2</sup> SYSTEM

indeks	wielkość	DN	PN	Tmax	pakowanie		cena netto [zł]
<b>06-001-1010-020</b>	3/8" x 3/8" x 20	8	10	+70°C	10	200	<b>10,14</b>
<b>06-001-1010-030</b>	3/8" x 3/8" x 30	8	10	+70°C	10	200	<b>10,96</b>
<b>06-001-1010-040</b>	3/8" x 3/8" x 40	8	10	+70°C	10	150	<b>12,14</b>
<b>06-001-1010-050</b>	3/8" x 3/8" x 50	8	10	+70°C	10	150	<b>13,17</b>
<b>06-001-1010-060</b>	3/8" x 3/8" x 60	8	10	+70°C	10	100	<b>14,43</b>
<b>06-001-1510-020</b>	1/2" x 3/8" x 20	8	10	+70°C	10	200	<b>10,87</b>
<b>06-001-1510-030</b>	1/2" x 3/8" x 30	8	10	+70°C	10	200	<b>11,52</b>
<b>06-001-1510-040</b>	1/2" x 3/8" x 40	8	10	+70°C	10	150	<b>12,81</b>
<b>06-001-1510-050</b>	1/2" x 3/8" x 50	8	10	+70°C	10	150	<b>14,10</b>
<b>06-001-1510-060</b>	1/2" x 3/8" x 60	8	10	+70°C	10	100	<b>14,98</b>
<b>06-001-1515-020</b>	1/2" x 1/2" x 20	8	10	+70°C	10	200	<b>10,58</b>
<b>06-001-1515-025</b>	1/2" x 1/2" x 25	8	10	+70°C	10	200	<b>11,15</b>
<b>06-001-1515-030</b>	1/2" x 1/2" x 30	8	10	+70°C	10	200	<b>11,90</b>
<b>06-001-1515-035</b>	1/2" x 1/2" x 35	8	10	+70°C	10	200	<b>12,43</b>
<b>06-001-1515-040</b>	1/2" x 1/2" x 40	8	10	+70°C	10	150	<b>12,81</b>
<b>06-001-1515-045</b>	1/2" x 1/2" x 45	8	10	+70°C	10	150	<b>13,24</b>
<b>06-001-1515-050</b>	1/2" x 1/2" x 50	8	10	+70°C	10	150	<b>13,72</b>
<b>06-001-1515-055</b>	1/2" x 1/2" x 55	8	10	+70°C	10	140	<b>14,16</b>
<b>06-001-1515-060</b>	1/2" x 1/2" x 60	8	10	+70°C	10	100	<b>14,62</b>
<b>06-001-1515-070</b>	1/2" x 1/2" x 70	8	10	+70°C	10	100	<b>16,08</b>
<b>06-001-1515-080</b>	1/2" x 1/2" x 80	8	10	+70°C	10	100	<b>16,65</b>
<b>06-001-1515-090</b>	1/2" x 1/2" x 90	8	10	+70°C	10	100	<b>18,29</b>
<b>06-001-1515-100</b>	1/2" x 1/2" x 100	8	10	+70°C	10	80	<b>19,47</b>
<b>06-001-1515-120</b>	1/2" x 1/2" x 120	8	10	+70°C	10	50	<b>21,55</b>
<b>06-001-1515-150</b>	1/2" x 1/2" x 150	8	10	+70°C	10	50	<b>25,58</b>

## PHA-9125

Przyłącze elastyczne w oplocie ze stali nierdzewnej WW

**E** GRUPA RABATOWA

PERFEKT<sup>2</sup> SYSTEM

indeks	wielkość	DN	PN	Tmax	pakowanie		cena netto [zł]
<b>06-002-1520-030</b>	1/2" x 3/4" x 30	8	10	+70°C	10	270	<b>14,55</b>
<b>06-002-1520-040</b>	1/2" x 3/4" x 40	8	10	+70°C	10	160	<b>15,77</b>
<b>06-002-1520-050</b>	1/2" x 3/4" x 50	8	10	+70°C	10	140	<b>17,55</b>
<b>06-002-2020-030</b>	3/4" x 3/4" x 30	8	10	+70°C	10	220	<b>22,81</b>
<b>06-002-2020-040</b>	3/4" x 3/4" x 40	8	10	+70°C	10	160	<b>24,91</b>
<b>06-002-2020-050</b>	3/4" x 3/4" x 50	8	10	+70°C	10	140	<b>28,12</b>

**PHA-9126**Przyłącze elastyczne z kolankiem  
w oplocie ze stali nierdzewnej WW**E** GRUPA RABATOWA**PERFEKT<sup>2</sup>SYSTEM**

indeks	wielkość	DN	PN	Tmax	pakowanie		cena netto [zł]
<b>06-005-1515-040</b>	½" x ½" x 40	8	10	+70°C	1	120	<b>30,61</b>
<b>06-005-1515-050</b>	½" x ½" x 50	8	10	+70°C	1	100	<b>32,68</b>
<b>06-005-1515-060</b>	½" x ½" x 60	8	10	+70°C	1	100	<b>34,74</b>
<b>06-005-1515-080</b>	½" x ½" x 80	8	10	+70°C	1	70	<b>38,90</b>
<b>06-005-1515-100</b>	½" x ½" x 100	8	10	+70°C	1	60	<b>42,88</b>
<b>06-005-1515-120</b>	½" x ½" x 120	8	10	+70°C	1	50	<b>47,02</b>
<b>06-005-1515-150</b>	½" x ½" x 150	8	10	+70°C	1	40	<b>51,16</b>

**PHA-9145/C**Przyłącze elastyczne do baterii  
w oplocie ze stali nierdzewnej, krótkie**E** GRUPA RABATOWA**PERFEKT<sup>2</sup>SYSTEM**

indeks	wielkość	DN	PN	Tmax	pakowanie		cena netto [zł]
<b>06-003-1010-030</b>	M10x1 x ¾" x 30	8	10	+70°C	10	200	<b>10,24</b>
<b>06-003-1010-040</b>	M10x1 x ¾" x 40	8	10	+70°C	10	150	<b>11,08</b>
<b>06-003-1010-050</b>	M10x1 x ¾" x 50	8	10	+70°C	10	240	<b>12,08</b>
<b>06-003-1010-060</b>	M10x1 x ¾" x 60	8	10	+70°C	10	100	<b>13,08</b>
<b>06-003-1010-080</b>	M10x1 x ¾" x 80	8	10	+70°C	10	100	<b>13,74</b>
<b>06-003-1510-030</b>	M10x1 x ½" x 30	8	10	+70°C	10	300	<b>10,33</b>
<b>06-003-1510-035</b>	M10x1 x ½" x 35	8	10	+70°C	10	150	<b>10,87</b>
<b>06-003-1510-040</b>	M10x1 x ½" x 40	8	10	+70°C	10	150	<b>11,41</b>
<b>06-003-1510-050</b>	M10x1 x ½" x 50	8	10	+70°C	10	100	<b>12,47</b>
<b>06-003-1510-060</b>	M10x1 x ½" x 60	8	10	+70°C	10	100	<b>13,59</b>
<b>06-003-1510-070</b>	M10x1 x ½" x 70	8	10	+70°C	10	200	<b>14,64</b>
<b>06-003-1510-080</b>	M10x1 x ½" x 80	8	10	+70°C	10	130	<b>15,75</b>

**PHA-9155 wąż antywibracyjny**Przyłącze w oplocie ze stali  
nierdzewnej WW**K** GRUPA RABATOWA**PERFEKT<sup>2</sup>SYSTEM**

indeks	wielkość	DN	PN	Tmax	pakowanie		cena netto [zł]
<b>06-011-0150-030</b>	½" x 30	13	12	+110°C	1	1	<b>30,74</b>
<b>06-011-0150-040</b>	½" x 40	13	12	+110°C	1	1	<b>33,15</b>
<b>06-011-0150-050</b>	½" x 50	13	12	+110°C	1	1	<b>35,58</b>
<b>06-011-0150-060</b>	½" x 60	13	12	+110°C	1	1	<b>37,96</b>
<b>06-011-0200-030</b>	¾" x 30	18	12	+110°C	1	1	<b>50,93</b>
<b>06-011-0200-040</b>	¾" x 40	18	12	+110°C	1	1	<b>54,80</b>
<b>06-011-0200-050</b>	¾" x 50	18	12	+110°C	1	1	<b>58,64</b>
<b>06-011-0200-060</b>	¾" x 60	18	12	+110°C	1	1	<b>62,52</b>
<b>06-011-0200-070</b>	¾" x 70	18	12	+110°C	1	1	<b>66,40</b>
<b>06-011-0200-080</b>	¾" x 80	18	12	+110°C	1	1	<b>70,25</b>
<b>06-011-0200-090</b>	¾" x 90	18	12	+110°C	1	1	<b>74,13</b>
<b>06-011-0200-100</b>	¾" x 100	18	12	+110°C	1	1	<b>77,98</b>
<b>06-011-0200-120</b>	¾" x 120	18	12	+110°C	1	1	<b>85,65</b>
<b>06-011-0200-150</b>	¾" x 150	18	12	+110°C	1	1	<b>97,27</b>
<b>06-011-0250-030</b>	1" x 30	25	10	+110°C	1	1	<b>69,49</b>
<b>06-011-0250-040</b>	1" x 40	25	10	+110°C	1	1	<b>74,09</b>
<b>06-011-0250-050</b>	1" x 50	25	10	+110°C	1	1	<b>78,59</b>
<b>06-011-0250-060</b>	1" x 60	25	10	+110°C	1	1	<b>83,16</b>
<b>06-011-0250-070</b>	1" x 70	25	10	+110°C	1	1	<b>87,76</b>
<b>06-011-0250-080</b>	1" x 80	25	10	+110°C	1	1	<b>92,31</b>
<b>06-011-0250-090</b>	1" x 90	25	10	+110°C	1	1	<b>96,82</b>
<b>06-011-0250-100</b>	1" x 100	25	10	+110°C	1	1	<b>101,40</b>
<b>06-011-0250-120</b>	1" x 120	25	10	+110°C	1	1	<b>116,97</b>
<b>06-011-0250-150</b>	1" x 150	25	10	+110°C	1	1	<b>131,46</b>
<b>06-011-0320-030</b>	1¼" x 30	32	10	+110°C	1	1	<b>236,59</b>
<b>06-011-0320-040</b>	1¼" x 40	32	10	+110°C	1	1	<b>259,02</b>
<b>06-011-0320-050</b>	1¼" x 50	32	10	+110°C	1	1	<b>281,45</b>
<b>06-011-0320-060</b>	1¼" x 60	32	10	+110°C	1	1	<b>303,83</b>
<b>06-011-0320-070</b>	1¼" x 70	32	10	+110°C	1	1	<b>326,25</b>
<b>06-011-0320-080</b>	1¼" x 80	32	10	+110°C	1	1	<b>348,67</b>

**PHA-9150 wąż antywibracyjny**

Przyłącze elastyczne w oplocie ze stali nierdzewnej WZ

**(K)** GRUPA RABATOWA**PERFEKT<sup>2</sup>SYSTEM**

indeks	wielkość	DN	PN	Tmax	pakowanie	cena netto [zł]
<b>06-010-0150-030</b>	½" x 30	13	12	+110°C	1 1	<b>32,15</b>
<b>06-010-0150-040</b>	½" x 40	13	12	+110°C	1 1	<b>34,80</b>
<b>06-010-0150-050</b>	½" x 50	13	12	+110°C	1 1	<b>37,32</b>
<b>06-010-0150-060</b>	½" x 60	13	12	+110°C	1 1	<b>39,83</b>
<b>06-010-0200-030</b>	¾" x 30	18	12	+110°C	1 1	<b>53,48</b>
<b>06-010-0200-040</b>	¾" x 40	18	12	+110°C	1 1	<b>57,54</b>
<b>06-010-0200-050</b>	¾" x 50	18	12	+110°C	1 1	<b>61,58</b>
<b>06-010-0200-060</b>	¾" x 60	18	12	+110°C	1 1	<b>65,66</b>
<b>06-010-0200-070</b>	¾" x 70	18	12	+110°C	1 1	<b>69,72</b>
<b>06-010-0200-080</b>	¾" x 80	18	12	+110°C	1 1	<b>73,76</b>
<b>06-010-0200-090</b>	¾" x 90	18	12	+110°C	1 1	<b>77,83</b>
<b>06-010-0200-100</b>	¾" x 100	18	12	+110°C	1 1	<b>81,87</b>
<b>06-010-0200-120</b>	¾" x 120	18	12	+110°C	1 1	<b>90,00</b>
<b>06-010-0200-150</b>	¾" x 150	18	12	+110°C	1 1	<b>102,18</b>
<b>06-010-0250-030</b>	1" x 30	25	10	+110°C	1 1	<b>73,00</b>
<b>06-010-0250-040</b>	1" x 40	25	10	+110°C	1 1	<b>77,81</b>
<b>06-010-0250-050</b>	1" x 50	25	10	+110°C	1 1	<b>82,52</b>
<b>06-010-0250-060</b>	1" x 60	25	10	+110°C	1 1	<b>87,33</b>
<b>06-010-0250-070</b>	1" x 70	25	10	+110°C	1 1	<b>92,15</b>
<b>06-010-0250-080</b>	1" x 80	25	10	+110°C	1 1	<b>96,93</b>
<b>06-010-0250-090</b>	1" x 90	25	10	+110°C	1 1	<b>101,65</b>
<b>06-010-0250-100</b>	1" x 100	25	10	+110°C	1 1	<b>106,46</b>
<b>06-010-0250-120</b>	1" x 120	25	10	+110°C	1 1	<b>122,84</b>
<b>06-010-0250-150</b>	1" x 150	25	10	+110°C	1 1	<b>138,01</b>
<b>06-010-0320-030</b>	1¼" x 30	32	10	+110°C	1 1	<b>248,45</b>
<b>06-010-0320-040</b>	1¼" x 40	32	10	+110°C	1 1	<b>272,00</b>
<b>06-010-0320-050</b>	1¼" x 50	32	10	+110°C	1 1	<b>295,51</b>
<b>06-010-0320-060</b>	1¼" x 60	32	10	+110°C	1 1	<b>319,02</b>
<b>06-010-0320-070</b>	1¼" x 70	32	10	+110°C	1 1	<b>342,58</b>
<b>06-010-0320-080</b>	1¼" x 80	32	10	+110°C	1 1	<b>366,10</b>

**PHA-9156 wąż antywibracyjny**

Przyłącze w oplocie ze stali nierdzewnej z kolankiem WZ

**(K)** GRUPA RABATOWA**PERFEKT<sup>2</sup>SYSTEM**

indeks	wielkość	DN	PN	Tmax	pakowanie	cena netto [zł]
<b>06-012-0250-040</b>	1" x 40	25	10	+110°C	1 1	<b>77,02</b>
<b>06-012-0250-050</b>	1" x 50	25	10	+110°C	1 1	<b>81,66</b>
<b>06-012-0250-060</b>	1" x 60	25	10	+110°C	1 1	<b>86,38</b>
<b>06-012-0250-070</b>	1" x 70	25	10	+110°C	1 1	<b>91,08</b>
<b>06-012-0250-080</b>	1" x 80	25	10	+110°C	1 1	<b>95,70</b>
<b>06-012-0250-090</b>	1" x 90	25	10	+110°C	1 1	<b>100,41</b>
<b>06-012-0250-100</b>	1" x 100	25	10	+110°C	1 1	<b>105,11</b>
<b>06-012-0250-120</b>	1" x 120	25	10	+110°C	1 1	<b>114,47</b>
<b>06-012-0250-150</b>	1" x 150	25	10	+110°C	1 1	<b>128,52</b>

**PHA-9145/L**

Przyłącze elastyczne do baterii w oplocie ze stali nierdzewnej, długie

**(E)** GRUPA RABATOWA**PERFEKT<sup>2</sup>SYSTEM**

indeks	wielkość	DN	PN	Tmax	pakowanie	cena netto [zł]
<b>06-004-1010-030</b>	M10x1 x ¾" x 30	8	10	+70°C	10 200	<b>11,15</b>
<b>06-004-1010-040</b>	M10x1 x ¾" x 40	8	10	+70°C	10 150	<b>12,18</b>
<b>06-004-1010-050</b>	M10x1 x ¾" x 50	8	10	+70°C	10 150	<b>13,21</b>
<b>06-004-1010-060</b>	M10x1 x ¾" x 60	8	10	+70°C	10 100	<b>14,22</b>
<b>06-004-1010-080</b>	M10x1 x ¾" x 80	8	10	+70°C	10 100	<b>16,22</b>
<b>06-004-1510-030</b>	M10x1 x ½" x 30	8	10	+70°C	10 200	<b>11,63</b>
<b>06-004-1510-040</b>	M10x1 x ½" x 40	8	10	+70°C	10 150	<b>12,74</b>
<b>06-004-1510-050</b>	M10x1 x ½" x 50	8	10	+70°C	10 150	<b>13,80</b>
<b>06-004-1510-060</b>	M10x1 x ½" x 60	8	10	+70°C	10 100	<b>14,91</b>
<b>06-004-1510-070</b>	M10x1 x ½" x 70	8	10	+70°C	10 100	<b>16,00</b>
<b>06-004-1510-080</b>	M10x1 x ½" x 80	8	10	+70°C	10 100	<b>17,09</b>





# PERFEXIM

## CENNIK ARMATURA 2024



Produkty spełniające surowe wymagania wyrobów przeznaczonych do instalacji gazowych

### PERFEKT<sup>2</sup> SYSTEM

Gwarancja bezpieczeństwa  
- 100% kontrola szczelności

Wysoki poziom szczelności  
dzięki zastosowaniu dwóch  
niezależnych pierścieni typu „O”

Mosiądz CW617N  
w europejskim standardzie

# ARMATURA GAZOWA

## 32

Kurki kulowe	33
Filtry	33
Przyłącza	33



**PHA-255****PERFEKT SYSTEM**Kurek kulowy do gazu WW,  
MOP5 T2

C GRUPA RABATOWA

**PERFEKT<sup>2</sup>SYSTEM**

indeks	wielkość	pakowanie		cena netto [zł]
		☞	☞	
<b>10-255-0150-000</b>	½"	16	144	<b>29,46</b>
<b>10-255-0200-000</b>	¾"	10	90	<b>46,91</b>
<b>10-255-0250-000</b>	1"	8	64	<b>74,00</b>
<b>10-255-0320-000</b>	1¼"	4	32	<b>121,49</b>
<b>10-255-0400-000</b>	1½"	2	18	<b>166,80</b>
<b>10-255-0500-000</b>	2"	2	16	<b>284,18</b>

**PHA-260****PERFEKT SYSTEM**Filtr skośny do gazu,  
MOP5 T2

C GRUPA RABATOWA

**PERFEKT<sup>2</sup>SYSTEM**

indeks	wielkość	pakowanie		cena netto [zł]
		☞	☞	
<b>10-260-0150-000</b>	½"	12	168	<b>27,04</b>
<b>10-260-0200-000</b>	¾"	8	96	<b>44,53</b>
<b>10-260-0250-000</b>	1"	7	63	<b>59,98</b>
<b>10-260-0320-000</b>	1¼"	4	32	<b>119,21</b>
<b>10-260-0400-000</b>	1½"	2	18	<b>150,23</b>
<b>10-260-0500-000</b>	2"	2	16	<b>240,32</b>

**PHA-250/2****PERFEKT SYSTEM**Bezpieczny metalowy  
przewód przyłączeniowy  
WW Typ 1

K GRUPA RABATOWA

**PERFEKT<sup>2</sup>SYSTEM**

indeks	rozmiar	pakowanie		cena netto [zł]
		☞	☞	
<b>11-016-0500-000</b>	500	1	200	<b>63,73</b>
<b>11-016-0750-000</b>	750	1	200	<b>68,32</b>
<b>11-016-1000-000</b>	1000	1	175	<b>71,49</b>
<b>11-016-1250-000</b>	1250	1	150	<b>83,45</b>
<b>11-016-1500-000</b>	1500	1	125	<b>94,61</b>
<b>11-016-2000-000</b>	2000	1	100	<b>113,00</b>

**PHA-251/2****PERFEKT SYSTEM**Bezpieczny metalowy  
przewód przyłączeniowy  
WZ do gazu Typ1

K GRUPA RABATOWA

**PERFEKT<sup>2</sup>SYSTEM**

indeks	rozmiar	pakowanie		cena netto [zł]
		☞	☞	
<b>11-017-0500-000</b>	500	1	200	<b>63,73</b>
<b>11-017-0750-000</b>	750	1	200	<b>68,32</b>
<b>11-017-1000-000</b>	1000	1	175	<b>71,49</b>
<b>11-017-1250-000</b>	1250	1	150	<b>83,45</b>
<b>11-017-1500-000</b>	1500	1	125	<b>94,61</b>
<b>11-017-2000-000</b>	2000	1	100	<b>113,00</b>

**Przewód rozciągliwy**Przewód rozciągliwy  
do gazu WZ

K GRUPA RABATOWA

indeks	rozmiar	zakres długości	PN	DN	Tmax	pakowanie		cena netto [zł]
						☞	☞	
<b>11-012-0130-000</b>	½" x ½"	130-220mm	5	16	+120°C	1	50	<b>40,57</b>
<b>11-012-0220-000</b>	½" x ½"	220-420mm	5	16	+120°C	1	40	<b>47,34</b>
<b>11-012-0300-000</b>	½" x ½"	300-600mm	5	16	+120°C	1	50	<b>58,15</b>
<b>11-012-0500-000</b>	½" x ½"	500-1000mm	5	16	+120°C	1	40	<b>75,72</b>
<b>11-012-0750-000</b>	½" x ½"	750-1500mm	5	16	+120°C	1	50	<b>87,89</b>
<b>11-013-0130-000</b>	¾" x ¾"	130-220mm	5	20	+120°C	1	50	<b>63,55</b>
<b>11-013-0220-000</b>	¾" x ¾"	220-420mm	5	20	+120°C	1	50	<b>74,37</b>
<b>11-013-0300-000</b>	¾" x ¾"	300-600mm	5	20	+120°C	1	40	<b>87,89</b>
<b>11-013-0500-000</b>	¾" x ¾"	500-1000mm	5	20	+120°C	1	30	<b>112,23</b>
<b>11-013-0750-000</b>	¾" x ¾"	750-1500mm	5	20	+120°C	1	30	<b>120,35</b>
<b>11-013-1000-000</b>	¾" x ¾"	1000-2000mm	5	20	+120°C	1	30	<b>129,82</b>



Profesjonalne  
rozdzielenie ciepła

# PERFEXIM

CENNIK ARMATURA 2024



93.5

PERFEKT<sup>2</sup> SYSTEM

Ochrona zdrowotna i antyalergiczna  
- brak niklu na powierzchniach  
mających kontakt z wodą pitną

Ułatwienie prac instalatorskich  
przez różne konfiguracje  
spełniające oczekiwania

Stal nierdzewna gatunku 1.4301  
o europejskim standardzie

# ARMATURA CENTRALNEGO OGRZEWANIA

34-54

System antyzamroziowy	35
Komplety / głowice termostatyczne	35
Zawory grzejnikowe	39
Zawory bezpieczeństwa	42
Pompy obiegowe	43
Rozdzielacze, osprzęt rozdzielaczy	44
Zawory odpowietrzające	53
Automatyka ogrzewania	54
Uchwyty do bojlerów	54

**PHA-SAZ/2**

System antyzamrozienny do pomp ciepła typu monoblok

**PERFEKT<sup>2</sup>SYSTEM**

indeks	pakowanie	cena netto [zł]
<b>58-000-0000-000</b>	1 1	<b>1900,00</b>
<b>58-000-0000-100</b>	1 1	<b>2100,00</b>

(K) GRUPA RABATOWA

**PHA-024**

Komplet termostatyczny prosty

**PERFEKT<sup>2</sup>SYSTEM**

indeks	wielkość	PN	kolor	Tmax	pakowanie	cena netto [zł]
<b>20-024-0000-000</b>	½"	10	chrom	+120°C	1 30	<b>107,61</b>

(K) GRUPA RABATOWA

**PHA-024W**

Komplet termostatyczny prosty

**PERFEKT<sup>2</sup>SYSTEM**

indeks	wielkość	PN	kolor	Tmax	pakowanie	cena netto [zł]
<b>20-024-0000-001</b>	½"	10	biały	+120°C	1 30	<b>118,25</b>

(K) GRUPA RABATOWA

**PHA-025**

Komplet termostatyczny kątowy

**PERFEKT<sup>2</sup>SYSTEM**

indeks	wielkość	PN	kolor	Tmax	pakowanie	cena netto [zł]
<b>20-025-0000-000</b>	½"	10	chrom	+120°C	1 30	<b>113,00</b>

(K) GRUPA RABATOWA

**PHA-025W**

Komplet termostatyczny kątowy

**PERFEKT<sup>2</sup>SYSTEM**

indeks	wielkość	PN	kolor	Tmax	pakowanie	cena netto [zł]
<b>20-025-0000-001</b>	½"	10	biały	+120°C	1 30	<b>118,25</b>

(K) GRUPA RABATOWA

**PHA-026**

Komplet termostatyczny z nastawą wstępną, prosty

**PERFEKT<sup>2</sup>SYSTEM**

indeks	wielkość	PN	Tmax	pakowanie	cena netto [zł]
<b>20-026-0000-000</b>	½"	10	+120°C	1 1	<b>109,08</b>

(K) GRUPA RABATOWA

**PHA-027**

Komplet termostatyczny z nastawą wstępną, kątowy

**PERFEKT<sup>2</sup>SYSTEM**

indeks	wielkość	PN	Tmax	pakowanie	cena netto [zł]
<b>20-027-0000-000</b>	½"	10	+120°C	1 1	<b>109,08</b>

(K) GRUPA RABATOWA

## PHA-036

Zintegrowany zestaw termostatyczny z nastawą wstępną, kątowy



**(K)** GRUPA RABATOWA



chromowany



biały



grafit



czarny mat



czarny struktura

PERFEKT<sup>SYSTEM</sup>

indeks	wielkość	PN	kolor	Tmax	pakowanie		cena netto [zł]
<b>20-036-0000-000</b>	½"	10	chrom	+120°C	1	20	<b>202,15</b>
<b>20-036-0000-001</b>	½"	10	biały	+120°C	1	20	<b>207,20</b>
<b>20-036-0000-002</b>	½"	10	grafit	+120°C	1	20	<b>224,89</b>
<b>20-036-0000-003</b>	½"	10	czarny mat	+120°C	1	20	<b>224,89</b>
<b>20-036-0000-004</b>	½"	10	czarny struktura	+120°C	1	20	<b>224,89</b>

## PHA-037

Komplet termostatyczny z nastawą wstępną "lewy"



**(K)** GRUPA RABATOWA



chromowany



biały



grafit



czarny mat



czarny struktura

PERFEKT<sup>SYSTEM</sup>

indeks	wielkość	PN	kolor	Tmax	pakowanie		cena netto [zł]
<b>20-037-0000-000</b>	½"	10	chrom	+120°C	1	20	<b>199,62</b>
<b>20-037-0000-001</b>	½"	10	biały	+120°C	1	20	<b>202,15</b>
<b>20-037-0000-002</b>	½"	10	grafit	+120°C	1	20	<b>214,79</b>
<b>20-037-0000-003</b>	½"	10	czarny mat	+120°C	1	20	<b>214,79</b>
<b>20-037-0000-004</b>	½"	10	czarny struktura	+120°C	1	20	<b>214,79</b>

## PHA-038

Komplet termostatyczny z nastawą wstępną "prawy"



**(K)** GRUPA RABATOWA



chromowany



biały



grafit



czarny mat



czarny struktura

PERFEKT<sup>SYSTEM</sup>

indeks	wielkość	PN	kolor	Tmax	pakowanie		cena netto [zł]
<b>20-038-0000-000</b>	½"	10	chrom	+120°C	1	20	<b>199,62</b>
<b>20-038-0000-001</b>	½"	10	biały	+120°C	1	20	<b>202,15</b>
<b>20-038-0000-002</b>	½"	10	grafit	+120°C	1	20	<b>214,79</b>
<b>20-038-0000-003</b>	½"	10	czarny mat	+120°C	1	20	<b>214,79</b>
<b>20-038-0000-004</b>	½"	10	czarny struktura	+120°C	1	20	<b>214,79</b>

## 7024

Komplet termostatyczny prosty z głowicą z blokadą nastawy



**(E)** GRUPA RABATOWA

indeks	PN	Tmax	pakowanie		cena netto [zł]
<b>20-107-0200-000</b>	10	+120°C	1	40	<b>94,74</b>

## 7025

Komplet termostatyczny kątowy z głowicą z blokadą nastawy



**(E)** GRUPA RABATOWA

indeks	PN	Tmax	pakowanie		cena netto [zł]
<b>20-107-0200-010</b>	10	+120°C	1	40	<b>94,74</b>

## 7030

Komplet kątowy do podłączenia grzejnika, chromowany



**(E)** GRUPA RABATOWA

indeks	wielkość	PN	Tmax	pakowanie		cena netto [zł]
<b>20-108-0100-000</b>	½"	10	+120°C	1	55	<b>100,15</b>

## 7031

Komplet kątowy do podłączenia grzejnika, biały, wypukłe pokrętko



indeks	wielkość	PN	Tmax	pakowanie	cena netto [zł]
<b>20-108-0100-001</b>	½"	10	+120°C	1 55	<b>100,15</b>

**E** GRUPA RABATOWA

## 7032

Komplet kątowy do podłączenia grzejnika, wypukłe pokrętko



indeks	wielkość	PN	kolor	Tmax	pakowanie	cena netto [zł]
<b>20-108-0100-002</b>	½"	10	grafit	+120°C	1 55	<b>103,53</b>
<b>20-108-0100-003</b>	½"	10	czarny mat	+120°C	1 55	<b>103,53</b>
<b>20-108-0100-004</b>	½"	10	czarny struktura	+120°C	1 55	<b>103,53</b>

**E** GRUPA RABATOWA

## ZM02

Zestaw maskujący do grzejników z dwiema rozetami okrągłymi i tulejami



indeks	kolor	pakowanie	cena netto [zł]
<b>20-040-1000-200</b>	chrom	1 48	<b>38,85</b>
<b>20-040-1000-201</b>	biały	1 48	<b>38,85</b>
<b>20-040-1000-203</b>	czarny mat	1 48	<b>38,85</b>

**K** GRUPA RABATOWA



chrom



biały



czarny mat

## ZMK2

Zestaw maskujący do grzejników z dwiema rozetami kwadratowymi i tulejami



indeks	kolor	pakowanie	cena netto [zł]
<b>20-040-1020-200</b>	chrom	1 48	<b>57,75</b>
<b>20-040-1020-201</b>	biały	1 48	<b>57,75</b>
<b>20-040-1020-203</b>	czarny mat	1 48	<b>57,75</b>

**K** GRUPA RABATOWA



chrom



biały



czarny mat

## ZM01

Zestaw maskujący do grzejników z rozetą owalną i tulejami



indeks	kolor	pakowanie	cena netto [zł]
<b>20-040-1040-100</b>	chrom	1 48	<b>38,85</b>
<b>20-040-1040-101</b>	biały	1 48	<b>38,85</b>
<b>20-040-1040-103</b>	czarny mat	1 48	<b>38,85</b>

**K** GRUPA RABATOWA



chrom



biały



czarny mat

## ZMK1

Zestaw maskujący do grzejników z rozetą prostokątną i tulejami



indeks	kolor	pakowanie	cena netto [zł]
<b>20-040-1030-100</b>	chrom	1 48	<b>57,75</b>
<b>20-040-1030-101</b>	biały	1 48	<b>57,75</b>
<b>20-040-1030-103</b>	czarny mat	1 48	<b>57,75</b>

**K** GRUPA RABATOWA



chrom



biały



czarny mat

**TRCD10C**

Głowica termostatyczna cieczowa M30x1.5, chromowana



indeks	Tmax	pakowanie		cena netto [zł]
<b>20-107-0400-000</b>	+50°C	1	100	<b>38,23</b>

**E** GRUPA RABATOWA

**TRCD10**

Głowica termostatyczna cieczowa M30x1.5, biała



indeks	kolor	Tmax	pakowanie		cena netto [zł]
<b>20-107-0400-100</b>	biały	+50°C	1	100	<b>39,74</b>
<b>20-107-0400-003</b>	czarny mat	+50°C	1	100	<b>37,49</b>

**E** GRUPA RABATOWA



biały



czarny mat

**TRCD15**

Głowica termostatyczna cieczowa M30x1.5 z blokadą nastawy



indeks	Tmax	pakowanie		cena netto [zł]
<b>20-107-0300-000</b>	+50°C	1	100	<b>33,46</b>

**E** GRUPA RABATOWA

**GT01RA**

Głowica termostatyczna cieczowa z przyłączem RA z blokadą nastawy temperatury



dostępne w III kwartale 2024

indeks	Tmax	pakowanie		cena netto [zł]
<b>20-300-0009-000</b>	+50°C	1	100	

**E** GRUPA RABATOWA

**GT02RA**

Głowica termostatyczna cieczowa z przyłączem RA



dostępne w III kwartale 2024

indeks	Tmax	pakowanie		cena netto [zł]
<b>20-300-0010-000</b>	+50°C	1	100	

**E** GRUPA RABATOWA

**GT01**

Głowica termostatyczna cieczowa M30x1.5 z blokadą nastawy



dostępne w III kwartale 2024

indeks	Tmax	pakowanie		cena netto [zł]
<b>20-107-0300-003</b>	+50°C	1	100	<b>25,30</b>

**E** GRUPA RABATOWA

**GT03**

Głowica termostatyczna cieczowa M30x1.5 z blokadą nastawy



dostępne w III kwartale 2024

indeks	Tmax	pakowanie		cena netto [zł]
<b>20-107-0300-004</b>	+50°C	1	100	<b>25,30</b>

**E** GRUPA RABATOWA

**GT04****▶ NOWOŚĆ**

Głowica termostaticzna cieczowa M30x1.5 z blokadą nastawy



indeks	Tmax	pakowanie	cena netto [zł]
<b>20-107-0300-005</b>	+50°C	1 100	<b>25,30</b>

**(E)** GRUPA RABATOWA

dostępne w III kwartale 2024

**PHA-028**

Termostaticzny zawór grzejnikowy z nastawą wstępną, prosty



PERFEKT <sup>Q</sup> SYSTEM		indeks	wielkość	PN	Tmax	pakowanie	cena netto [zł]
<b>20-028-0000-000</b>			½"	10	+120°C	10 100	<b>50,44</b>

**(K)** GRUPA RABATOWA

**PHA-029**

Termostaticzny zawór grzejnikowy z nastawą wstępną, kątowy



PERFEKT <sup>Q</sup> SYSTEM		indeks	wielkość	PN	Tmax	pakowanie	cena netto [zł]
<b>20-029-0000-000</b>			½"	10	+120°C	10 100	<b>47,25</b>

**(K)** GRUPA RABATOWA

**PHA-030**

Zawór grzejnikowy prosty



PERFEKT <sup>Q</sup> SYSTEM		indeks	wielkość	PN	Tmax	pakowanie	cena netto [zł]
<b>20-030-0000-300</b>			¾"	10	+120°C	10 100	<b>32,68</b>
<b>20-030-0000-000</b>			½"	10	+120°C	10 100	<b>32,68</b>

**(K)** GRUPA RABATOWA

**PHA-031**

Zawór grzejnikowy odcinający prosty



PERFEKT <sup>Q</sup> SYSTEM		indeks	wielkość	PN	Tmax	pakowanie	cena netto [zł]
<b>20-031-0001-300</b>			¾"	10	+120°C	10 100	<b>29,63</b>
<b>20-031-0001-000</b>			½"	10	+120°C	12 120	<b>29,63</b>

**(K)** GRUPA RABATOWA

**PHA-032**

Zawór grzejnikowy kątowy



PERFEKT <sup>Q</sup> SYSTEM		indeks	wielkość	PN	Tmax	pakowanie	cena netto [zł]
<b>20-032-0100-300</b>			¾"	10	+120°C	10 100	<b>32,68</b>
<b>20-032-0100-000</b>			½"	10	+120°C	10 100	<b>32,68</b>

**(K)** GRUPA RABATOWA

**TRV02**

Zawór grzejnikowy odcinający prosty



indeks	wielkość	PN	Tmax	pakowanie	cena netto [zł]
<b>20-107-0300-001</b>	½"	10	+120°C	10 100	<b>25,38</b>

**(E)** GRUPA RABATOWA

**TRV04**

Zawór grzejnikowy odcinający kątowy



indeks	wielkość	PN	Tmax	pakowanie	cena netto [zł]
<b>20-107-0300-002</b>	½"	10	+120°C	10 100	<b>23,86</b>

**(E)** GRUPA RABATOWA

**PHA-030A**

Zawór grzejnikowy z gwintem samouszczelniającym, prosty

**(K)** GRUPA RABATOWA

**PERFEKT<sup>2</sup>SYSTEM**

indeks	wielkość	PN	Tmax	pakowanie		cena netto [zł]
<b>20-030-0000-100</b>	½"	10	+120°C	10	100	<b>33,02</b>

**PHA-031A**

Zawór grzejnikowy odcinający z gwintem samouszczelniającym, prosty

**(K)** GRUPA RABATOWA

**PERFEKT<sup>2</sup>SYSTEM**

indeks	wielkość	PN	Tmax	pakowanie		cena netto [zł]
<b>20-031-0001-100</b>	½"	10	+120°C	10	100	<b>30,33</b>

**PHA-032A**

Zawór grzejnikowy z gwintem samouszczelniającym, kątowy

**(K)** GRUPA RABATOWA

**PERFEKT<sup>2</sup>SYSTEM**

indeks	wielkość	PN	Tmax	pakowanie		cena netto [zł]
<b>20-032-0100-100</b>	½"	10	+120°C	10	100	<b>32,71</b>

**PHA-033A**

Zawór grzejnikowy odcinający z gwintem samouszczelniającym, kątowy

**(K)** GRUPA RABATOWA

**PERFEKT<sup>2</sup>SYSTEM**

indeks	wielkość	PN	Tmax	pakowanie		cena netto [zł]
<b>20-033-0101-100</b>	½"	10	+120°C	10	100	<b>29,97</b>

**PHA-030/L**

Zawór grzejnikowy do wlotowania, prosty

**(K)** GRUPA RABATOWA

Produkt dostępny do wyczerpania zapasów

**PERFEKT<sup>2</sup>SYSTEM**

indeks	wielkość	PN	Tmax	pakowanie		cena netto [zł]
<b>20-030-0000-200</b>	½" x 15	10	+120°C	10	100	<b>24,68</b>

**PHA-033**

Zawór grzejnikowy odcinający kątowy

**(K)** GRUPA RABATOWA

**PERFEKT<sup>2</sup>SYSTEM**

indeks	wielkość	PN	Tmax	pakowanie		cena netto [zł]
<b>20-033-0101-300</b>	¾"	10	+120°C	10	100	<b>29,63</b>
<b>20-033-0101-000</b>	½"	10	+120°C	12	120	<b>29,63</b>

**PHA-032/L**

Zawór grzejnikowy do wlotowania, kątowy

**(K)** GRUPA RABATOWA

Produkt dostępny do wyczerpania zapasów

**PERFEKT<sup>2</sup>SYSTEM**

indeks	wielkość	PN	Tmax	pakowanie		cena netto [zł]
<b>20-032-0100-200</b>	½" x 15	10	+120°C	10	100	<b>24,68</b>





**PHA-033/L**

Zawór grzejnikowy odcinający do wlotowania, kątowy

PERFEKT<sup>SYSTEM</sup>

indeks	wielkość	PN	Tmax	pakowanie		cena netto [zł]
<b>20-033-0101-200</b>	½" x 15	10	+120°C	10	100	<b>21,08</b>

(K) GRUPA RABATOWA

Produkt dostępny do wyczerpania zapasów

**PHA-030/PEX**

Zawór grzejnikowy ze złączką do rury PEX lub PERT prosty

PERFEKT<sup>SYSTEM</sup>

indeks	wielkość	PN	Tmax	pakowanie		cena netto [zł]
<b>20-030-0000-003</b>	½"	10	+120°C	10	100	<b>28,46</b>

(K) GRUPA RABATOWA

**PHA-031/PEX**

Zawór grzejnikowy odcinający ze złączką do rury PEX lub PERT prosty

PERFEKT<sup>SYSTEM</sup>

indeks	wielkość	PN	Tmax	pakowanie		cena netto [zł]
<b>20-031-0001-003</b>	½"	10	+120°C	10	100	<b>24,92</b>

(K) GRUPA RABATOWA

**PHA-032/PEX**

Zawór grzejnikowy ze złączką do rury PEX lub PERT kątowy

PERFEKT<sup>SYSTEM</sup>

indeks	wielkość	PN	Tmax	pakowanie		cena netto [zł]
<b>20-032-0100-003</b>	½"	10	+120°C	10	100	<b>27,53</b>

(K) GRUPA RABATOWA

**PHA-033/PEX**

Zawór grzejnikowy odcinający ze złączką do rury PEX lub PERT kątowy

PERFEKT<sup>SYSTEM</sup>

indeks	wielkość	PN	Tmax	pakowanie		cena netto [zł]
<b>20-033-0101-003</b>	½"	10	+120°C	10	100	<b>24,92</b>

(K) GRUPA RABATOWA

**PHA-034**

Zawór grzejnikowy podwójny grzybkowy odcinający prosty z nyplami

PERFEKT<sup>SYSTEM</sup>

indeks	wielkość	PN	Tmax	pakowanie		cena netto [zł]
<b>20-034-0000-000</b>	½" x ¾"	10	+120°C	8	80	<b>65,16</b>

(K) GRUPA RABATOWA

**PHA-035**

Zawór grzejnikowy podwójny grzybkowy odcinający kątowy z nyplami

PERFEKT<sup>SYSTEM</sup>

indeks	wielkość	PN	Tmax	pakowanie		cena netto [zł]
<b>20-035-0000-000</b>	½" x ¾"	10	+120°C	8	80	<b>56,18</b>

(K) GRUPA RABATOWA

**PHA-035/1**

Zawór grzejnikowy podwójny  
grzybkowy odcinający  
kątowy bez nypli

PERFEKT<sup>2</sup> SYSTEM

indeks	wielkość	PN	Tmax	pakowanie		cena netto [zł]
<b>20-035-0000-001</b>	½" x ¾"	10	+120°C	8	80	<b>47,40</b>

**(K)** GRUPA RABATOWA

**7006+8021**

Zawór grzejnikowy podwójny  
kulowy odcinający prosty  
z nyplami



indeks	wielkość	PN	Tmax	pakowanie		cena netto [zł]
<b>20-104-0002-000</b>	½" x ¾"	10	+120°C	10	100	<b>63,54</b>

**(E)** GRUPA RABATOWA

**7005+8021**

Zawór grzejnikowy podwójny  
kulowy odcinający kątowy  
z nyplami



indeks	wielkość	PN	Tmax	pakowanie		cena netto [zł]
<b>20-104-0001-000</b>	½" x ¾"	10	+120°C	10	100	<b>60,64</b>

**(E)** GRUPA RABATOWA

**8021/S**

Nypel do zaworu  
grzejnikowego  
(PHA-034 i PHA-035)



indeks	wielkość	PN	Tmax	pakowanie		cena netto [zł]
<b>20-104-2001-000</b>	½" x ¾"	10	+120°C	10	700	<b>8,69</b>

**(K)** GRUPA RABATOWA

**8021**

Nypel do zaworu  
grzejnikowego kulowego  
podwójnego  
(a.7005 i a.7006)



indeks	wielkość	PN	Tmax	pakowanie		cena netto [zł]
<b>20-104-2000-000</b>	½" x ¾"	10	+110°C	10	1000	<b>8,44</b>

**(E)** GRUPA RABATOWA

**111-1(110/L)  
111-3(110/L)**

Zawór bezpieczeństwa  
z zaworem zwrotnym  
i spustem



indeks	DN	ciśnienie nastawne [bar]	Tmax	pakowanie		cena netto [zł]
<b>20-201-0150-000</b>	15	7	+100°C	1	150	<b>31,57</b>
<b>20-201-0200-000</b>	20	7	+100°C	1	125	<b>40,73</b>

**(C)** GRUPA RABATOWA

**7036B**

Zawór bezpieczeństwa  
z zaworem zwrotnym  
i spustem



indeks	DN	ciśnienie nastawne [bar]	Tmax	pakowanie		cena netto [zł]
<b>20-202-0150-000</b>	15	7	+95°C	20	200	<b>17,55</b>
<b>20-202-0200-000</b>	20	7	+95°C	10	100	<b>33,94</b>

**(E)** GRUPA RABATOWA

**PHA-402**

Pompa obiegowa PERFEKT do instalacji c.o. sterowana elektronicznie

PERFEKT<sup>SYSTEM</sup>

indeks	wielkość	wysokość podnoszenia [m]	pakowanie	cena netto [zł]
<b>31-402-0000-000</b>	180 mm	4	1 8	<b>632,18</b>

**P** GRUPA RABATOWA

**PHA-602**

Pompa obiegowa PERFEKT do instalacji c.o. sterowana elektronicznie

PERFEKT<sup>SYSTEM</sup>

indeks	wielkość	wysokość podnoszenia [m]	pakowanie	cena netto [zł]
<b>31-602-0000-000</b>	180 mm	6	1 8	<b>653,67</b>

**P** GRUPA RABATOWA

**PHA-602/P**

Pompa obiegowa PERFEKT do instalacji c.o. ogrzewania podłogowego sterowana elektronicznie

PERFEKT<sup>SYSTEM</sup>

indeks	wielkość	wysokość podnoszenia [m]	pakowanie	cena netto [zł]
<b>31-602-0001-000</b>	130 mm	6	1 8	<b>653,67</b>

**P** GRUPA RABATOWA

**CRS25/40**

Pompa obiegowa do wody pitnej



indeks	wielkość	wysokość podnoszenia [m]	pakowanie	cena netto [zł]
<b>31-254-0000-000</b>	180 mm	4	1 8	<b>226,50</b>

**P** GRUPA RABATOWA

**CRS25/60**

Pompa obiegowa do wody pitnej



indeks	wielkość	wysokość podnoszenia [m]	pakowanie	cena netto [zł]
<b>31-256-0000-000</b>	180 mm	6	1 8	<b>230,79</b>

**P** GRUPA RABATOWA

**SP**

Śrubunek z uszczelką do pompy



indeks	wielkość	PN	Tmax	pakowanie	cena netto [zł]
<b>31-900-0002-000</b>	1" x 1½"	10	+100°C	1 100	<b>7,80</b>

**P** GRUPA RABATOWA

**PHA-100**Rozdzielacz mosiężny  
grzejnikowy prosty**(K1)** GRUPA RABATOWA**PERFEKT<sup>Q</sup>**  
SYSTEM

indeks	ilość obwodów	PN	Tmax	pakowanie		cena netto [zł]
<b>30-100-0202-000</b>	2	10	+95°C	1	1	<b>153,26</b>
<b>30-100-0302-000</b>	3	10	+95°C	1	1	<b>210,48</b>
<b>30-100-0402-000</b>	4	10	+95°C	1	1	<b>271,37</b>
<b>30-100-0502-000</b>	5	10	+95°C	1	1	<b>330,07</b>
<b>30-100-0602-000</b>	6	10	+95°C	1	1	<b>386,38</b>
<b>30-100-0702-000</b>	7	10	+95°C	1	1	<b>447,17</b>
<b>30-100-0802-000</b>	8	10	+95°C	1	1	<b>497,52</b>
<b>30-100-0902-000</b>	9	10	+95°C	1	1	<b>550,29</b>
<b>30-100-1002-000</b>	10	10	+95°C	1	1	<b>600,53</b>
<b>30-100-1102-000</b>	11	10	+95°C	1	1	<b>658,33</b>
<b>30-100-1202-000</b>	12	10	+95°C	1	1	<b>711,11</b>

**PHA-102**Rozdzielacz mosiężny  
grzejnikowy prosty  
z nyplami**(K1)** GRUPA RABATOWA**PERFEKT<sup>Q</sup>**  
SYSTEM

indeks	ilość obwodów	PN	Tmax	pakowanie		cena netto [zł]
<b>30-102-0202-000</b>	2	10	+95°C	1	1	<b>206,00</b>
<b>30-102-0302-000</b>	3	10	+95°C	1	1	<b>291,10</b>
<b>30-102-0402-000</b>	4	10	+95°C	1	1	<b>362,77</b>
<b>30-102-0502-000</b>	5	10	+95°C	1	1	<b>459,07</b>
<b>30-102-0602-000</b>	6	10	+95°C	1	1	<b>535,21</b>
<b>30-102-0702-000</b>	7	10	+95°C	1	1	<b>606,86</b>
<b>30-102-0802-000</b>	8	10	+95°C	1	1	<b>703,15</b>
<b>30-102-0902-000</b>	9	10	+95°C	1	1	<b>779,30</b>
<b>30-102-1002-000</b>	10	10	+95°C	1	1	<b>868,86</b>
<b>30-102-1102-000</b>	11	10	+95°C	1	1	<b>951,73</b>
<b>30-102-1202-000</b>	12	10	+95°C	1	1	<b>1034,97</b>

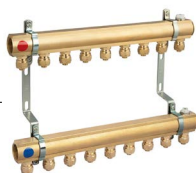
**PHA-102/Z**Rozdzielacz mosiężny  
ze złączkami do rur PEX**(K1)** GRUPA RABATOWA**PERFEKT<sup>Q</sup>**  
SYSTEM

indeks	ilość obwodów	PN	Tmax	pakowanie		cena netto [zł]
<b>30-102-0200-004</b>	2	10	+95°C	1	1	<b>234,26</b>
<b>30-102-0300-004</b>	3	10	+95°C	1	1	<b>332,76</b>
<b>30-102-0400-004</b>	4	10	+95°C	1	1	<b>417,28</b>
<b>30-102-0500-004</b>	5	10	+95°C	1	1	<b>527,42</b>
<b>30-102-0600-004</b>	6	10	+95°C	1	1	<b>616,63</b>
<b>30-102-0700-004</b>	7	10	+95°C	1	1	<b>701,16</b>
<b>30-102-0800-004</b>	8	10	+95°C	1	1	<b>811,29</b>
<b>30-102-0900-004</b>	9	10	+95°C	1	1	<b>900,48</b>
<b>30-102-1000-004</b>	10	10	+95°C	1	1	<b>1003,66</b>
<b>30-102-1100-004</b>	11	10	+95°C	1	1	<b>1099,81</b>
<b>30-102-1200-004</b>	12	10	+95°C	1	1	<b>1196,41</b>

## PHA-107

Rozdzielacz mosiężny z rotametrem 0-5l do ogrzewania podłogowego

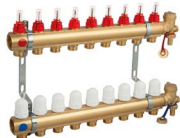

 GRUPA RABATOWA

Możliwość podłączenia zespołu mieszającego - rozstaw 210mm.



 **NOWOŚĆ**

PERFEKT<sup>SYSTEM</sup>

indeks	ilość obwodów	PN	Tmax	pakowanie		cena netto [zł]
						
30-107-0200-000	2	6	+70°C	1	1	340,00
30-107-0300-000	3	6	+70°C	1	1	440,00
30-107-0400-000	4	6	+70°C	1	1	540,00
30-107-0500-000	5	6	+70°C	1	1	640,00
30-107-0600-000	6	6	+70°C	1	1	730,00
30-107-0700-000	7	6	+70°C	1	1	830,00
30-107-0800-000	8	6	+70°C	1	1	920,00
30-107-0900-000	9	6	+70°C	1	1	1020,00
30-107-1000-000	10	6	+70°C	1	1	1120,00
30-107-1100-000	11	6	+70°C	1	1	1220,00
30-107-1200-000	12	6	+70°C	1	1	1310,00
30-107-1300-000	13	6	+70°C	1	1	1480,00
30-107-1400-000	14	6	+70°C	1	1	1580,00
30-107-1500-000	15	6	+70°C	1	1	1680,00
30-107-1600-000	16	6	+70°C	1	1	1780,00

## PHA-107/Z

Rozdzielacz mosiężny z rotametrem 0-5l, ze złączkami do rur PEX - do ogrzewania podłogowego

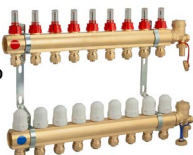

 GRUPA RABATOWA

Możliwość podłączenia zespołu mieszającego - rozstaw 210mm.



 **NOWOŚĆ**

PERFEKT<sup>SYSTEM</sup>

indeks	ilość obwodów	PN	Tmax	pakowanie		cena netto [zł]
						
30-107-0200-004	2	6	+70°C	1	1	388,00
30-107-0300-004	3	6	+70°C	1	1	512,00
30-107-0400-004	4	6	+70°C	1	1	636,00
30-107-0500-004	5	6	+70°C	1	1	760,00
30-107-0600-004	6	6	+70°C	1	1	874,00
30-107-0700-004	7	6	+70°C	1	1	998,00
30-107-0800-004	8	6	+70°C	1	1	1112,00
30-107-0900-004	9	6	+70°C	1	1	1236,00
30-107-1000-004	10	6	+70°C	1	1	1360,00
30-107-1100-004	11	6	+70°C	1	1	1484,00
30-107-1200-004	12	6	+70°C	1	1	1598,00
30-107-1300-004	13	6	+70°C	1	1	1792,00
30-107-1400-004	14	6	+70°C	1	1	1916,00
30-107-1500-004	15	6	+70°C	1	1	2040,00
30-107-1600-004	16	6	+70°C	1	1	2164,00



## PHA-107/1/S

Rozdzielacz mosiężny z rotametrem 0-5l do ogrzewania podłogowego

 GRUPA RABATOWA

Możliwość podłączenia zespołu mieszającego - rozstaw 210mm.

PERFEKT<sup>SYSTEM</sup>

indeks	ilość obwodów	PN	Tmax	pakowanie		cena netto [zł]
						
30-107-0200-011	2	6	+70°C	1	1	310,00
30-107-0300-011	3	6	+70°C	1	1	410,00
30-107-0400-011	4	6	+70°C	1	1	510,00
30-107-0500-011	5	6	+70°C	1	1	610,00
30-107-0600-011	6	6	+70°C	1	1	700,00
30-107-0700-011	7	6	+70°C	1	1	800,00
30-107-0800-011	8	6	+70°C	1	1	890,00
30-107-0900-011	9	6	+70°C	1	1	990,00
30-107-1000-011	10	6	+70°C	1	1	1090,00
30-107-1100-011	11	6	+70°C	1	1	1190,00
30-107-1200-011	12	6	+70°C	1	1	1280,00
30-107-1300-011	13	6	+70°C	1	1	1420,00
30-107-1400-011	14	6	+70°C	1	1	1520,00
30-107-1500-011	15	6	+70°C	1	1	1620,00
30-107-1600-011	16	6	+70°C	1	1	1720,00

**PHA-107/1/S/Z****NOWOŚĆ**Rozdzielacz mosiężny  
ze złączkami do rur  
warstwowych**K3** GRUPA RABATOWAMożliwość podłączenia zespołu  
mieszającego - rozstaw 210mm.PERFEKT<sup>SYSTEM</sup>

indeks	ilość obwodów	PN	Tmax	pakowanie		cena netto [zł]
<b>30-107-0200-014</b>	2	6	+70°C	1	1	<b>358,00</b>
<b>30-107-0300-014</b>	3	6	+70°C	1	1	<b>482,00</b>
<b>30-107-0400-014</b>	4	6	+70°C	1	1	<b>606,00</b>
<b>30-107-0500-014</b>	5	6	+70°C	1	1	<b>730,00</b>
<b>30-107-0600-014</b>	6	6	+70°C	1	1	<b>844,00</b>
<b>30-107-0700-014</b>	7	6	+70°C	1	1	<b>968,00</b>
<b>30-107-0800-014</b>	8	6	+70°C	1	1	<b>1082,00</b>
<b>30-107-0900-014</b>	9	6	+70°C	1	1	<b>1206,00</b>
<b>30-107-1000-014</b>	10	6	+70°C	1	1	<b>1330,00</b>
<b>30-107-1100-014</b>	11	6	+70°C	1	1	<b>1454,00</b>
<b>30-107-1200-014</b>	12	6	+70°C	1	1	<b>1568,00</b>
<b>30-107-1300-014</b>	13	6	+70°C	1	1	<b>1732,00</b>
<b>30-107-1400-014</b>	14	6	+70°C	1	1	<b>1856,00</b>
<b>30-107-1500-014</b>	15	6	+70°C	1	1	<b>1980,00</b>
<b>30-107-1600-014</b>	16	6	+70°C	1	1	<b>2104,00</b>

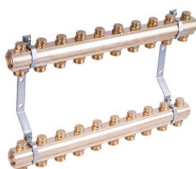
**PHA-109**Rozdzielacz mosiężny  
z wkładkami zaworowymi  
odcinającymi**K2** GRUPA RABATOWAPERFEKT<sup>SYSTEM</sup>

indeks	ilość obwodów	PN	Tmax	pakowanie		cena netto [zł]
<b>30-109-0200-000</b>	2	10	+95°C	1	1	<b>224,08</b>
<b>30-109-0300-000</b>	3	10	+95°C	1	1	<b>311,21</b>
<b>30-109-0400-000</b>	4	10	+95°C	1	1	<b>404,58</b>
<b>30-109-0500-000</b>	5	10	+95°C	1	1	<b>506,27</b>
<b>30-109-0600-000</b>	6	10	+95°C	1	1	<b>587,16</b>
<b>30-109-0700-000</b>	7	10	+95°C	1	1	<b>676,40</b>
<b>30-109-0800-000</b>	8	10	+95°C	1	1	<b>746,94</b>
<b>30-109-0900-000</b>	9	10	+95°C	1	1	<b>840,29</b>
<b>30-109-1000-000</b>	10	10	+95°C	1	1	<b>910,85</b>
<b>30-109-1100-000</b>	11	10	+95°C	1	1	<b>995,92</b>
<b>30-109-1200-000</b>	12	10	+95°C	1	1	<b>1089,28</b>

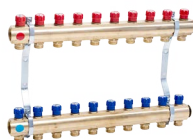
**PHA-109A**Rozdzielacz mosiężny  
- komplet**K2** GRUPA RABATOWAPERFEKT<sup>SYSTEM</sup>

indeks	ilość obwodów	PN	Tmax	pakowanie		cena netto [zł]
<b>30-109-0200-002</b>	2	10	+95°C	1	1	<b>232,55</b>
<b>30-109-0300-002</b>	3	10	+95°C	1	1	<b>322,97</b>
<b>30-109-0400-002</b>	4	10	+95°C	1	1	<b>419,86</b>
<b>30-109-0500-002</b>	5	10	+95°C	1	1	<b>525,35</b>
<b>30-109-0600-002</b>	6	10	+95°C	1	1	<b>609,33</b>
<b>30-109-0700-002</b>	7	10	+95°C	1	1	<b>701,92</b>
<b>30-109-0800-002</b>	8	10	+95°C	1	1	<b>775,12</b>
<b>30-109-0900-002</b>	9	10	+95°C	1	1	<b>872,00</b>
<b>30-109-1000-002</b>	10	10	+95°C	1	1	<b>945,57</b>
<b>30-109-1100-002</b>	11	10	+95°C	1	1	<b>1033,36</b>
<b>30-109-1200-002</b>	12	10	+95°C	1	1	<b>1130,38</b>

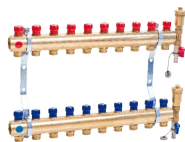
**PHA-109A/1**Rozdzielacz mosiężny  
- komplet

GRUPA RABATOWA

**PERFEKT<sup>Q</sup>SYSTEM**

indeks	ilość obwodów	PN	Tmax	pakowanie	cena netto [zł]
<b>30-109-0200-001</b>	2	10	+95°C	1 1	<b>340,26</b>
<b>30-109-0300-001</b>	3	10	+95°C	1 1	<b>428,46</b>
<b>30-109-0400-001</b>	4	10	+95°C	1 1	<b>516,67</b>
<b>30-109-0500-001</b>	5	10	+95°C	1 1	<b>608,46</b>
<b>30-109-0600-001</b>	6	10	+95°C	1 1	<b>693,10</b>
<b>30-109-0700-001</b>	7	10	+95°C	1 1	<b>777,71</b>
<b>30-109-0800-001</b>	8	10	+95°C	1 1	<b>864,13</b>
<b>30-109-0900-001</b>	9	10	+95°C	1 1	<b>955,93</b>
<b>30-109-1000-001</b>	10	10	+95°C	1 1	<b>1040,55</b>
<b>30-109-1100-001</b>	11	10	+95°C	1 1	<b>1128,77</b>
<b>30-109-1200-001</b>	12	10	+95°C	1 1	<b>1216,98</b>

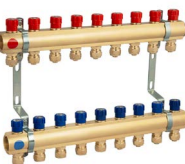
**PHA-109A/Z**Rozdzielacz mosiężny  
z wkładkami zaworowymi  
odcinającymi ze złączkami  
do rur PEX - komplet

GRUPA RABATOWA

**PERFEKT<sup>Q</sup>SYSTEM**

indeks	ilość obwodów	PN	Tmax	pakowanie	cena netto [zł]
<b>30-109-0200-004</b>	2	10	+95°C	1 1	<b>230,49</b>
<b>30-109-0300-004</b>	3	10	+95°C	1 1	<b>350,70</b>
<b>30-109-0400-004</b>	4	10	+95°C	1 1	<b>456,87</b>
<b>30-109-0500-004</b>	5	10	+95°C	1 1	<b>571,61</b>
<b>30-109-0600-004</b>	6	10	+95°C	1 1	<b>664,82</b>
<b>30-109-0700-004</b>	7	10	+95°C	1 1	<b>766,66</b>
<b>30-109-0800-004</b>	8	10	+95°C	1 1	<b>849,10</b>
<b>30-109-0900-004</b>	9	10	+95°C	1 1	<b>955,24</b>
<b>30-109-1000-004</b>	10	10	+95°C	1 1	<b>1038,04</b>
<b>30-109-1100-004</b>	11	10	+95°C	1 1	<b>1135,08</b>
<b>30-109-1200-004</b>	12	10	+95°C	1 1	<b>1241,36</b>

**PHA-120**Rozdzielacz ze stali  
nierdzewnej

GRUPA RABATOWA

**PERFEKT<sup>Q</sup>SYSTEM**

indeks	ilość obwodów	PN	Tmax	pakowanie	cena netto [zł]
<b>30-120-0200-001</b>	2	10	+95°C	1 1	<b>138,28</b>
<b>30-120-0300-001</b>	3	10	+95°C	1 1	<b>191,07</b>
<b>30-120-0400-001</b>	4	10	+95°C	1 1	<b>235,14</b>
<b>30-120-0500-001</b>	5	10	+95°C	1 1	<b>279,25</b>
<b>30-120-0600-001</b>	6	10	+95°C	1 1	<b>320,39</b>
<b>30-120-0700-001</b>	7	10	+95°C	1 1	<b>363,02</b>
<b>30-120-0800-001</b>	8	10	+95°C	1 1	<b>404,16</b>
<b>30-120-0900-001</b>	9	10	+95°C	1 1	<b>442,40</b>
<b>30-120-1000-001</b>	10	10	+95°C	1 1	<b>479,14</b>
<b>30-120-1100-001</b>	11	10	+95°C	1 1	<b>529,11</b>
<b>30-120-1200-001</b>	12	10	+95°C	1 1	<b>571,72</b>

**PHA-122**Rozdzielacz ze stali  
nierdzewnej z nypłami

GRUPA RABATOWA

**PERFEKT<sup>Q</sup>SYSTEM**

indeks	ilość obwodów	PN	Tmax	pakowanie	cena netto [zł]
<b>30-122-0200-001</b>	2	10	+95°C	1 1	<b>177,11</b>
<b>30-122-0300-001</b>	3	10	+95°C	1 1	<b>242,19</b>
<b>30-122-0400-001</b>	4	10	+95°C	1 1	<b>302,77</b>
<b>30-122-0500-001</b>	5	10	+95°C	1 1	<b>363,32</b>
<b>30-122-0600-001</b>	6	10	+95°C	1 1	<b>420,83</b>
<b>30-122-0700-001</b>	7	10	+95°C	1 1	<b>479,89</b>
<b>30-122-0800-001</b>	8	10	+95°C	1 1	<b>537,40</b>
<b>30-122-0900-001</b>	9	10	+95°C	1 1	<b>591,88</b>
<b>30-122-1000-001</b>	10	10	+95°C	1 1	<b>644,88</b>
<b>30-122-1100-001</b>	11	10	+95°C	1 1	<b>711,49</b>
<b>30-122-1200-001</b>	12	10	+95°C	1 1	<b>770,52</b>

## PHA-127

Rozdzielacz ze stali nierdzewnej z rotametrem 0-5l do ogrzewania podłogowego

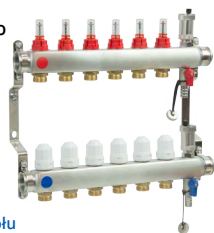

 GRUPA RABATOWA



Możliwość podłączenia zespołu mieszającego - rozstaw 210mm.

 **NOWOŚĆ**

PERFEKT<sup>2</sup>SYSTEM

indeks	ilość obwodów	PN	Tmax	pakowanie		cena netto [zł]
						
30-127-0200-001	2	6	+70°C	1	1	378,00
30-127-0300-001	3	6	+70°C	1	1	473,00
30-127-0400-001	4	6	+70°C	1	1	574,00
30-127-0500-001	5	6	+70°C	1	1	670,00
30-127-0600-001	6	6	+70°C	1	1	770,00
30-127-0700-001	7	6	+70°C	1	1	868,00
30-127-0800-001	8	6	+70°C	1	1	963,00
30-127-0900-001	9	6	+70°C	1	1	1062,00
30-127-1000-001	10	6	+70°C	1	1	1160,00
30-127-1100-001	11	6	+70°C	1	1	1244,00
30-127-1200-001	12	6	+70°C	1	1	1347,00
30-127-1300-001	13	6	+70°C	1	1	1469,00
30-127-1400-001	14	6	+70°C	1	1	1571,00
30-127-1500-001	15	6	+70°C	1	1	1671,00
30-127-1600-001	16	6	+70°C	1	1	1775,00

## PHA-127/Z

 **NOWOŚĆ**



Rozdzielacz ze stali nierdzewnej ze złączkami do rur wielowarstwowych

 GRUPA RABATOWA



Możliwość podłączenia zespołu mieszającego - rozstaw 210mm.

PERFEKT<sup>2</sup>SYSTEM

indeks	ilość obwodów	PN	Tmax	pakowanie		cena netto [zł]
						
30-127-0200-004	2	6	+70°C	1	1	426,00
30-127-0300-004	3	6	+70°C	1	1	545,00
30-127-0400-004	4	6	+70°C	1	1	670,00
30-127-0500-004	5	6	+70°C	1	1	790,00
30-127-0600-004	6	6	+70°C	1	1	914,00
30-127-0700-004	7	6	+70°C	1	1	1036,00
30-127-0800-004	8	6	+70°C	1	1	1155,00
30-127-0900-004	9	6	+70°C	1	1	1278,00
30-127-1000-004	10	6	+70°C	1	1	1400,00
30-127-1100-004	11	6	+70°C	1	1	1508,00
30-127-1200-004	12	6	+70°C	1	1	1635,00
30-127-1300-004	13	6	+70°C	1	1	1781,00
30-127-1400-004	14	6	+70°C	1	1	1907,00
30-127-1500-004	15	6	+70°C	1	1	2031,00
30-127-1600-004	16	6	+70°C	1	1	2159,00

## PHA-127/1/S

 **NOWOŚĆ**

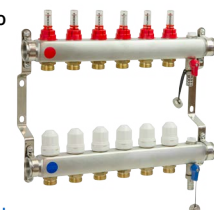

Rozdzielacz ze stali nierdzewnej z rotametrem 0-5l do ogrzewania podłogowego

 GRUPA RABATOWA



Możliwość podłączenia zespołu mieszającego - rozstaw 210mm.

PERFEKT<sup>2</sup>SYSTEM

indeks	ilość obwodów	PN	Tmax	pakowanie		cena netto [zł]
						
30-127-0200-011	2	6	+70°C	1	1	348,00
30-127-0300-011	3	6	+70°C	1	1	443,00
30-127-0400-011	4	6	+70°C	1	1	544,00
30-127-0500-011	5	6	+70°C	1	1	640,00
30-127-0600-011	6	6	+70°C	1	1	740,00
30-127-0700-011	7	6	+70°C	1	1	838,00
30-127-0800-011	8	6	+70°C	1	1	933,00
30-127-0900-011	9	6	+70°C	1	1	1032,00
30-127-1000-011	10	6	+70°C	1	1	1130,00
30-127-1100-011	11	6	+70°C	1	1	1214,00
30-127-1200-011	12	6	+70°C	1	1	1317,00
30-127-1300-011	13	6	+70°C	1	1	1439,00
30-127-1400-011	14	6	+70°C	1	1	1541,00
30-127-1500-011	15	6	+70°C	1	1	1641,00
30-127-1600-011	16	6	+70°C	1	1	1745,00



## PHA-127/1/S/Z

NOWOŚĆ

PERFEKT<sup>2</sup> SYSTEM

Rozdzielacz ze stali nierdzewnej  
ze złączkami do rur  
wielowarstwowych

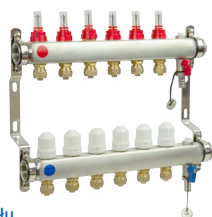

**K3** GRUPA RABATOWA

Możliwość podłączenia zespołu  
mieszającego - rozstaw 210mm.

indeks	ilość obwodów	PN	Tmax	pakowanie		cena netto [zł]
<b>30-127-0200-014</b>	2	6	+70°C	1	1	<b>396,00</b>
<b>30-127-0300-014</b>	3	6	+70°C	1	1	<b>515,00</b>
<b>30-127-0400-014</b>	4	6	+70°C	1	1	<b>640,00</b>
<b>30-127-0500-014</b>	5	6	+70°C	1	1	<b>760,00</b>
<b>30-127-0600-014</b>	6	6	+70°C	1	1	<b>884,00</b>
<b>30-127-0700-014</b>	7	6	+70°C	1	1	<b>1006,00</b>
<b>30-127-0800-014</b>	8	6	+70°C	1	1	<b>1125,00</b>
<b>30-127-0900-014</b>	9	6	+70°C	1	1	<b>1248,00</b>
<b>30-127-1000-014</b>	10	6	+70°C	1	1	<b>1370,00</b>
<b>30-127-1100-014</b>	11	6	+70°C	1	1	<b>1478,00</b>
<b>30-127-1200-014</b>	12	6	+70°C	1	1	<b>1605,00</b>
<b>30-127-1300-014</b>	13	6	+70°C	1	1	<b>1751,00</b>
<b>30-127-1400-014</b>	14	6	+70°C	1	1	<b>1877,00</b>
<b>30-127-1500-014</b>	15	6	+70°C	1	1	<b>2001,00</b>
<b>30-127-1600-014</b>	16	6	+70°C	1	1	<b>2129,00</b>

## PHA-129A/1

PERFEKT<sup>2</sup> SYSTEM

Rozdzielacz ze stali  
nierdzewnej - komplet



**K2** GRUPA RABATOWA

indeks	ilość obwodów	PN	Tmax	pakowanie		cena netto [zł]
<b>30-129-0200-001</b>	2	10	+95°C	1	1	<b>360,98</b>
<b>30-129-0300-001</b>	3	10	+95°C	1	1	<b>461,73</b>
<b>30-129-0400-001</b>	4	10	+95°C	1	1	<b>554,07</b>
<b>30-129-0500-001</b>	5	10	+95°C	1	1	<b>654,82</b>
<b>30-129-0600-001</b>	6	10	+95°C	1	1	<b>738,75</b>
<b>30-129-0700-001</b>	7	10	+95°C	1	1	<b>822,71</b>
<b>30-129-0800-001</b>	8	10	+95°C	1	1	<b>898,28</b>
<b>30-129-0900-001</b>	9	10	+95°C	1	1	<b>990,61</b>
<b>30-129-1000-001</b>	10	10	+95°C	1	1	<b>1082,96</b>
<b>30-129-1100-001</b>	11	10	+95°C	1	1	<b>1175,30</b>
<b>30-129-1200-001</b>	12	10	+95°C	1	1	<b>1259,28</b>

**PHA-131**

Zespół mieszający do ogrzewania podłogowego z pompą Grundfos i zaworem trójdrożnym termost. temp. 20-43°C kv2.5



**K2** GRUPA RABATOWA

**PERFEKT<sup>2</sup>SYSTEM**

indeks	PN	Tmax	pakowanie	cena netto [zł]
<b>30-600-0000-003</b>	10	+75°C	1 4	<b>2317,79</b>

**PHA-131/1**

Zespół mieszający do ogrzewania podłogowego z pompą Grundfos i z-rem trójdrożnym termost.temp.20-43°C, kv 2,5 i uchwytem 555/1

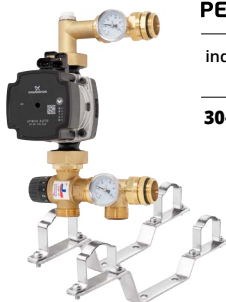

**K2** GRUPA RABATOWA

**PERFEKT<sup>2</sup>SYSTEM**

indeks	PN	Tmax	pakowanie	cena netto [zł]
<b>30-600-0000-006</b>	10	+75°C	1 8	<b>2350,80</b>

**PHA-132**

**NOWOŚĆ**

Trójdrożny termostatyczny zawór mieszający



**K** GRUPA RABATOWA

**PERFEKT<sup>2</sup>SYSTEM**

indeks	wielkość	PN	Tmax	pakowanie	cena netto [zł]
<b>30-601-0250-000</b>	1"	10	+70°C	1 40	<b>185,00</b>

**PHA-061M**

Separator magnetyczny



**K** GRUPA RABATOWA

**PERFEKT<sup>2</sup>SYSTEM**

indeks	wielkość	Magnes neodymowy	Tmax	pakowanie	cena netto [zł]
<b>03-061-0200-000</b>	¾"	9000 Gs	+90°C	1 10	<b>240,00</b>

**PHA-063M**

Separator magnetyczny



**K** GRUPA RABATOWA

**PERFEKT<sup>2</sup>SYSTEM**

indeks	wielkość	Magnes neodymowy	Tmax	pakowanie	cena netto [zł]
<b>03-063-0250-000</b>	1"	12000 Gs	+90°C	1 6	<b>510,00</b>
<b>03-063-0320-000</b>	1¼"	12000 Gs	+90°C	1 6	<b>600,00</b>

**PHA-064M**

**NOWOŚĆ**

Separator magnetyczny MAX FLOW z filtrem i odpowietrznikiem



**K** GRUPA RABATOWA

**PERFEKT<sup>2</sup>SYSTEM**

indeks	wielkość	Przepływ Qm³/h	Magnes neodymowy	Tmax	pakowanie	cena netto [zł]
<b>03-064-0250-000</b>	1"	4,37	9000 Gs	+90°C	1 6	<b>535,00</b>
<b>03-064-0320-000</b>	1¼"	4,95	9000 Gs	+90°C	1 6	<b>635,00</b>

**PHA-090**

Zacisk do rur PEX lub PERT

PERFEKT<sup>2</sup> SYSTEM

indeks	wielkość	PN	Tmax	pakowanie	cena netto [zł]
<b>20-090-0000-000</b>	16 x 2	10	+90°C	10 280	<b>8,00</b>

(K) GRUPA RABATOWA

**PHA-090/1**

Zacisk do rur wielowarstwowych

PERFEKT<sup>2</sup> SYSTEM

indeks	wielkość	PN	Tmax	pakowanie	cena netto [zł]
<b>20-090-0160-001</b>	16 x 2	10	+90°C	10 280	
<b>20-090-0170-001</b>	17 x 2	10	+90°C		<b>8,65</b>
<b>20-090-0180-001</b>	18 x 2	10	+90°C		<b>8,85</b>
<b>20-090-0200-001</b>	20 x 2	10	+90°C		<b>10,62</b>

(K) GRUPA RABATOWA  
dostępne w III kwartale 2024**215E**

Zacisk do rur miedzianych

PERFEKT<sup>2</sup> SYSTEM

indeks	wielkość	PN	Tmax	pakowanie	cena netto [zł]
<b>20-104-9001-000</b>	ø15	10	+100°C	30 240	<b>10,57</b>

(E) GRUPA RABATOWA

**PHA-098**

Zespół odpowietrzająco spustowy do rozdzielacza

PERFEKT<sup>2</sup> SYSTEM

indeks	kolor	PN	Tmax	pakowanie	cena netto [zł]
<b>30-200-0980-000</b>	czzerwony	10	+120°C	10 40	<b>68,69</b>
<b>30-200-0980-010</b>	niebieski	10	+120°C	10 40	<b>68,69</b>

(K) GRUPA RABATOWA

**SS555/1**

Uchwyt do rozdzielacza ze stali nierdzewnej



indeks	rozstaw [mm]	pakowanie	cena netto [zł]
<b>30-200-5551-200</b>	210	1 60	<b>25,09</b>

(D) GRUPA RABATOWA

**555/1**

Uchwyt do rozdzielaczy mosiężnych serii PHA-107



<b>30-200-5551-000</b>	210	1 60	<b>15,61</b>
------------------------	-----	------	--------------

(D) GRUPA RABATOWA

**748U**

Nypel do belki rozdzielacza mosiężnego uniwersalny



indeks	wielkość	PN	Tmax	pakowanie	cena netto [zł]
<b>30-200-7480-002</b>	½" x ¾"	10	+95°C	125 500	<b>9,66</b>

(K2) GRUPA RABATOWA

**749**

Korek do belki rozdzielacza mosiężnego



indeks	PN	Tmax	pakowanie	cena netto [zł]
<b>30-200-7490-000</b>	10	+95°C	100 400	<b>10,15</b>

(D) GRUPA RABATOWA

762

Złączka wkrętna-nypel z wymiową końcówką do wkładek zaworowych do rozdzielaczy



indeks	PN	Tmax	pakowanie		cena netto [zł]
<b>30-200-7550-020</b>	10	+95°C	10	200	<b>16,27</b>

**D** GRUPA RABATOWA

763

Złączka wkrętna-nypel z wymiową końcówką do wkładek zaworowych do rozdzielaczy



indeks	PN	Tmax	pakowanie		cena netto [zł]
<b>30-200-7550-021</b>	10	+95°C	100	400	<b>8,50</b>

**D** GRUPA RABATOWA

750

Wkładka zaworowa regulacyjna do belki rozdzielacza mosiężnego



indeks	PN	Tmax	pakowanie		cena netto [zł]
<b>30-200-7500-000</b>	10	+95°C	10	100	<b>42,21</b>

**D** GRUPA RABATOWA

751

Wkładka zaworowa odcinająca do belki rozdzielacza mosiężnego



indeks	PN	Tmax	pakowanie		cena netto [zł]
<b>30-200-7510-000</b>	10	+95°C	1	10	<b>34,47</b>

**D** GRUPA RABATOWA

757

Wkładka zaworowa odcinająco-regulacyjna do belki rozdzielacza mosiężnego



indeks	PN	Tmax	pakowanie		cena netto [zł]
<b>30-200-7570-000</b>	10	+95°C	10	100	<b>40,10</b>
<b>30-200-7570-010</b>	10	+95°C	10	100	<b>40,10</b>

**D** GRUPA RABATOWA

753

Przepływomierz P1/2" 0-5l/min z nypem do belki rozdzielacza mosiężnego



indeks	PN	Tmax	pakowanie		cena netto [zł]
<b>30-200-7530-000</b>	6	+70°C	1	1	<b>22,29</b>

**D** GRUPA RABATOWA

752

Głowica termostatyczna M30x1.5 z kapilarą



indeks	wielkość	pakowanie		cena netto [zł]
<b>30-200-7520-000</b>	M30x1.5	1	50	<b>154,57</b>

**D** GRUPA RABATOWA

**747**

Trójnik do belki rozdzielacza mosiężnego



indeks	wielkość	pakowanie		cena netto [zł]
<b>30-200-7470-000</b>	½" x 1" x ½"	10	200	<b>20,83</b>

**D** GRUPA RABATOWA**9003+S**

Odpowietrznik automatyczny z zaworem stopowym, mosiężny



indeks	wielkość	PN	Tmax	pakowanie		cena netto [zł]
<b>20-400-0003-000</b>	½"	10	+110°C	1	100	<b>27,58</b>

**B** GRUPA RABATOWA**9003C+S**

Odpowietrznik automatyczny z zaworem stopowym, chromowany



indeks	wielkość	PN	Tmax	pakowanie		cena netto [zł]
<b>20-400-0003-001</b>	½"	10	+110°C	1	100	<b>28,43</b>

**B** GRUPA RABATOWA**418**

Odpowietrznik ręczny



indeks	wielkość	PN	Tmax	pakowanie		cena netto [zł]
<b>20-401-0150-001</b>	½"	10	+120°C	100	500	<b>6,55</b>

**E** GRUPA RABATOWA**417**

Odpowietrznik ręczny o-ring



indeks	wielkość	PN	Tmax	pakowanie		cena netto [zł]
<b>20-401-0150-000</b>	½"	10	+120°C	10	600	<b>4,26</b>

**E** GRUPA RABATOWA**4220**

Kluczyk do odpowietrznika ręcznego o-ring



indeks	pakowanie		cena netto [zł]
<b>20-402-0001-000</b>	500	2500	<b>1,46</b>

**E** GRUPA RABATOWA**4216**

Korek zaślepiający o-ring



indeks	wielkość	PN	Tmax	pakowanie		cena netto [zł]
<b>20-402-0000-000</b>	½"	10	+120°C	100	1000	<b>3,15</b>

**E** GRUPA RABATOWA

**TS+5.11/230**

Siłownik termiczny  
beźprądowo zamknięty  
M30x1,5

PERFEKT<sup>2</sup> SYSTEM

indeks	wielkość	pakowanie		cena netto [zł]
<b>32-000-0000-000</b>	M30x1,5	1	40	<b>112,64</b>

**K2** GRUPA RABATOWA

**E200**

Regulator temperatury  
cyfrowy tygodniowy

PERFEKT<sup>2</sup> SYSTEM

indeks	pakowanie		cena netto [zł]
<b>32-000-1000-000</b>	1	48	<b>332,38</b>

**K2** GRUPA RABATOWA

**RTR3520**

Termostat pokojowy

PERFEKT<sup>2</sup> SYSTEM

indeks	pakowanie		cena netto [zł]
<b>32-000-3000-000</b>	1	25	<b>64,75</b>

**K2** GRUPA RABATOWA

**INSTAT868A1A**

Odbiornik radiowy  
do siłowników i pomp

PERFEKT<sup>2</sup> SYSTEM

indeks	pakowanie		cena netto [zł]
<b>32-000-0001-000</b>	1	1	<b>304,11</b>

**K2** GRUPA RABATOWA

**B-002**

Komplet uchwyty  
do bojlera



indeks	pakowanie		cena netto [zł]
<b>20-900-0001-000</b>	1	5	<b>69,61</b>

**E** GRUPA RABATOWA

**B-003**

Komplet uchwyty  
do zbiornika  
wyrównawczego



indeks	pakowanie		cena netto [zł]
<b>20-900-0002-000</b>	1	5	<b>50,60</b>

**E** GRUPA RABATOWA



Pełny kompletny system  
- gwarancja jakości  
i zadowolenia

# PERFEXIM

CENNIK ARMATURA 2024



## PERFEKT<sup>?</sup>SYSTEM<sup>+</sup>

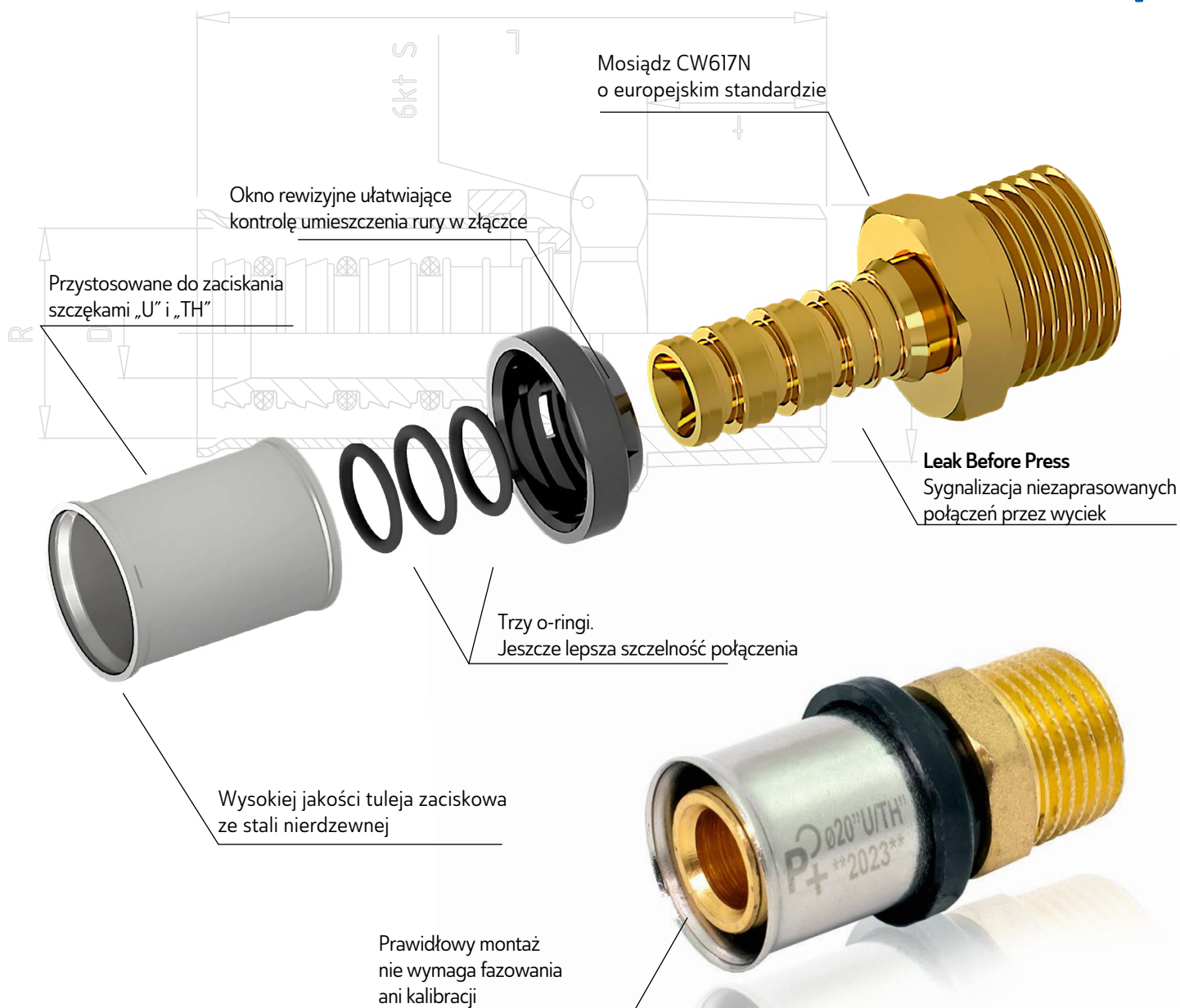

## SYSTEMY RUROWE WIELOWARSTWOWE 55-67

Rury PERT		56
Rury PEX		56
Złączki zaprasowywane	PERFEKT <sup>?</sup> SYSTEM <sup>+</sup>	57
Złączki zaprasowywane	PERFEKT <sup>?</sup> SYSTEM	60
Złączki skręcane		63
System montażowy		66
Narzędzia		67

## PARAMETRY

Parametry pracy rur wielowarstwowych PERT/AL/PERT, PEX/AL/PE oraz złączek skręcanych i zaprasowywanych są determinowane normą EN21003, która obecnie obowiązuje w Polsce.

Klasa	Pmax	Tmax
1	1,0 MPa	+60°C
5	0,6 MPa	+90°C

Parametry pracy rur wielowarstwowych PERT/EVOH/PERT

Klasa	Pmax	Tmax
4	1,0 MPa	+70°C

## 700EV

 **NOWOŚĆ**
PERFEKT<sup>2</sup> SYSTEM

**PERFEKT SYSTEM**  
Rura pert/evoh/pert



indeks	wielkość	pakowanie [mb]		cena netto [zł]
		krag	paleta	
<b>60-300-1600-600</b>	16 x 2,0	600	3600	<b>3,70</b>
<b>60-300-1720-500</b>	17 x 2,0	500		<b>3,70</b>
<b>60-300-1820-600</b>	18 x 2,0			



GRUPA RABATOWA

dostępne w II kwartale 2024  
dostępne w III kwartale 2024

## 700PER

PERFEKT<sup>2</sup> SYSTEM

**PERFEKT SYSTEM**  
Rura pert/al./pert



indeks	wielkość	pakowanie [mb]		cena netto [zł]
		krag	paleta	
<b>60-200-1620-200</b>	16 x 2,0	200	4000	<b>5,65</b>
<b>60-200-1620-500</b>	16 x 2,0	500	4000	<b>5,65</b>
<b>60-200-1820-200</b>	18 x 2,0	200		
<b>60-200-2000-100</b>	20 x 2,0	100	2000	<b>7,59</b>
<b>60-200-2500-050</b>	25 x 2,5	50	1000	<b>12,81</b>
<b>60-200-3200-025</b>	32 x 3,0	25	600	<b>21,53</b>
<b>60-200-4040-005</b>	40 x 4,0	5	25	<b>58,33</b>
<b>60-200-5045-005</b>	50 x 4,5	5	15	<b>87,50</b>
<b>60-200-6360-005</b>	63 x 6,0	5	15	<b>141,67</b>



GRUPA RABATOWA

## 700PER-IZO

PERFEKT<sup>2</sup> SYSTEM

**PERFEKT SYSTEM**  
Rura pert/al./pert w otulinie polietylenowej



indeks	wielkość	otulina [mm]	kolor otuliny	pakowanie [mb]		cena netto [zł]
				krag	paleta	
<b>60-200-1623-100</b>	16 x 2,0	9	niebieska	100	1400	<b>7,37</b>
<b>60-200-1624-100</b>	16 x 2,0	9	czerwona	100	1400	<b>7,37</b>
<b>60-200-2001-050</b>	20 x 2,0	9	niebieska	50	750	<b>10,61</b>
<b>60-200-2002-050</b>	20 x 2,0	9	czerwona	50	750	<b>10,61</b>
<b>60-200-2501-025</b>	25 x 2,5	9	niebieska	25	450	<b>16,87</b>
<b>60-200-2502-025</b>	25 x 2,5	9	czerwona	25	450	<b>16,87</b>
<b>60-200-3201-025</b>	32 x 3,0	9	niebieska	25	450	<b>27,16</b>
<b>60-200-3202-025</b>	32 x 3,0	9	czerwona	25	450	<b>27,16</b>



GRUPA RABATOWA

## 700PE

PERFEKT<sup>2</sup> SYSTEM

**PERFEKT SYSTEM**  
Rura pex/al./pe



indeks	wielkość	pakowanie [mb]		cena netto [zł]
		krag	paleta	
<b>60-100-1610-100</b>	16 x 2,0	100	4000	<b>5,35</b>
<b>60-100-1620-200</b>	16 x 2,0	200	4000	<b>5,35</b>
<b>60-100-1620-500</b>	16 x 2,0	500	4000	<b>5,35</b>
<b>60-100-2000-100</b>	20 x 2,0	100	1800	<b>6,89</b>
<b>60-100-2500-050</b>	25 x 2,5	50	1000	<b>11,06</b>
<b>60-100-3200-025</b>	32 x 3,0	25	600	<b>17,95</b>



GRUPA RABATOWA

700PE  
w odcinkach 5mPERFEKT<sup>2</sup> SYSTEM

**PERFEKT SYSTEM**  
Rura pex/al./pe



indeks	wielkość	pakowanie [mb]		cena netto [zł]
		odcinki	paleta	
<b>60-100-1620-005</b>	16 x 2,0	5	300	<b>5,35</b>
<b>60-100-2000-005</b>	20 x 2,0	5	225	<b>6,94</b>
<b>60-100-2500-005</b>	25 x 2,5	5	125	<b>11,39</b>
<b>60-100-3200-005</b>	32 x 3,0	5	75	<b>17,95</b>



GRUPA RABATOWA



## 901

**PERFEKT SYSTEM PLUS**  
Nypel zaprasowywany GZ

**G** GRUPA RABATOWA

\*) dostępny w III kwartale 2024

PERFEKT<sub>SYSTEM</sub>

indeks	wielkość	PN	Tmax	pakowanie		cena netto [zł]
<b>62-901-1615-000</b>	16 x 1/2"	10	+90°C	5	280	<b>17,36</b>
<b>62-901-1620-000</b>	16 x 3/4"	10	+90°C	5	200	<b>22,40</b>
<b>62-901-1815-000</b>	18 x 1/2"	10	+90°C	III kw.*	5 200	<b>19,60</b>
<b>62-901-1820-000</b>	18 x 3/4"	10	+90°C	III kw.*	5 200	<b>23,90</b>
<b>62-901-2015-000</b>	20 x 1/2"	10	+90°C	5	200	<b>24,89</b>
<b>62-901-2020-000</b>	20 x 3/4"	10	+90°C	5	200	<b>22,95</b>
<b>62-901-2025-000</b>	20 x 1"	10	+90°C	5	160	<b>25,35</b>
<b>62-901-2515-000</b>	25 x 1/2"	10	+90°C	5	120	<b>41,30</b>
<b>62-901-2520-000</b>	25 x 3/4"	10	+90°C	5	120	<b>46,35</b>
<b>62-901-2525-000</b>	25 x 1"	10	+90°C	6	144	<b>42,97</b>
<b>62-901-3225-000</b>	32 x 1"	10	+90°C	5	120	<b>69,60</b>
<b>62-901-3232-000</b>	32 x 1 1/4"	10	+90°C	5	90	<b>78,95</b>
<b>62-901-4032-000</b>	40 x 1 1/4"	10	+90°C	1	60	<b>110,53</b>
<b>62-901-4040-000</b>	40 x 1 1/2"	10	+90°C	1	56	<b>131,58</b>
<b>62-901-5040-000</b>	50 x 1 1/2"	10	+90°C	1	48	<b>144,74</b>
<b>62-901-5050-000</b>	50 x 2"	10	+90°C	1	30	<b>178,95</b>
<b>62-901-6340-000</b>	63 x 1 1/2"	10	+90°C	1	20	<b>300,00</b>
<b>62-901-6350-000</b>	63 x 2"	10	+90°C	1	20	<b>302,63</b>

## 902

**PERFEKT SYSTEM PLUS**  
Mufa zaprasowywana GW

**G** GRUPA RABATOWA

\*) dostępny w III kwartale 2024

PERFEKT<sub>SYSTEM</sub>

indeks	wielkość	PN	Tmax	pakowanie		cena netto [zł]
<b>62-902-1615-000</b>	16 x 1/2"	10	+90°C	3	240	<b>21,38</b>
<b>62-902-1620-000</b>	16 x 3/4"	10	+90°C	5	160	<b>26,95</b>
<b>62-902-1815-000</b>	18 x 1/2"	10	+90°C	III kw.*	3 240	<b>24,00</b>
<b>62-902-1820-000</b>	18 x 3/4"	10	+90°C	III kw.*	5 160	<b>27,50</b>
<b>62-902-2015-000</b>	20 x 1/2"	10	+90°C	3	240	<b>23,43</b>
<b>62-902-2020-000</b>	20 x 3/4"	10	+90°C	5	160	<b>26,40</b>
<b>62-902-2520-000</b>	25 x 3/4"	10	+90°C	5	120	<b>36,40</b>
<b>62-902-2525-000</b>	25 x 1"	10	+90°C	5	135	<b>49,12</b>
<b>62-902-3225-000</b>	32 x 1"	10	+90°C	5	135	<b>74,00</b>
<b>62-902-4032-000</b>	40 x 1 1/4"	10	+90°C	1	63	<b>115,79</b>
<b>62-902-4040-000</b>	40 x 1 1/2"	10	+90°C	1	48	<b>118,42</b>
<b>62-902-5040-000</b>	50 x 1 1/2"	10	+90°C	1	48	<b>142,11</b>
<b>62-902-6350-000</b>	63 x 2"	10	+90°C	1	20	<b>284,21</b>

## 902/O

**PERFEKT SYSTEM PLUS**  
Półśrubunek  
zaprasowywany GW

**G** GRUPA RABATOWA

\*) dostępny w III kwartale 2024

PERFEKT<sub>SYSTEM</sub>

indeks	wielkość	PN	Tmax	pakowanie		cena netto [zł]
<b>62-902-1615-001</b>	16 x 1/2"	10	+90°C	5	240	<b>32,80</b>
<b>62-902-1820-001</b>	18 x 3/4"	10	+90°C	III kw.*	4 220	<b>33,00</b>
<b>62-902-2015-001</b>	20 x 1/2"	10	+90°C	5	240	<b>39,47</b>
<b>62-902-2020-001</b>	20 x 3/4"	10	+90°C	5	160	<b>46,55</b>

## 903

**PERFEKT SYSTEM PLUS**  
 Złączka zaprasowywana

GRUPA RABATOWA

\*) dostępny w III kwartale 2024

**PERFEKT** SYSTEM<sup>+</sup>

indeks	wielkość	PN	Tmax	pakowanie		cena netto [zł]
<b>62-903-0160-000</b>	16	10	+90°C	5	240	<b>16,61</b>
<b>62-903-0180-000</b>	18	10	+90°C	5	200	<b>16,80</b>
<b>62-903-0200-000</b>	20	10	+90°C	5	200	<b>20,82</b>
<b>62-903-0250-000</b>	25	10	+90°C	5	120	<b>38,13</b>
<b>62-903-0320-000</b>	32	10	+90°C	5	100	<b>69,58</b>
<b>62-903-0400-000</b>	40	10	+90°C	1	42	<b>113,16</b>
<b>62-903-0500-000</b>	50	10	+90°C	1	33	<b>167,11</b>
<b>62-903-0630-000</b>	63	10	+90°C	1	15	<b>344,74</b>
<b>62-903-1816-000</b>	18 x 16	10	+90°C	5	200	<b>16,80</b>
<b>62-903-2016-000</b>	20 x 16	10	+90°C	5	200	<b>19,95</b>
<b>62-903-2018-000</b>	20 x 18	10	+90°C	5	200	<b>22,00</b>
<b>62-903-2516-000</b>	25 x 16	10	+90°C	5	120	<b>31,05</b>
<b>62-903-2518-000</b>	25 x 18	10	+90°C	5	120	<b>27,82</b>
<b>62-903-2520-000</b>	25 x 20	10	+90°C	5	120	<b>43,70</b>
<b>62-903-3216-000</b>	32 x 16	10	+90°C	5	120	<b>39,80</b>
<b>62-903-3218-000</b>	32 x 18	10	+90°C	5	120	<b>42,31</b>
<b>62-903-3220-000</b>	32 x 20	10	+90°C	5	80	<b>47,37</b>
<b>62-903-3225-000</b>	32 x 25	10	+90°C	1	100	<b>56,50</b>
<b>62-903-4025-000</b>	40 x 25	10	+90°C	1	42	<b>107,89</b>
<b>62-903-4032-000</b>	40 x 32	10	+90°C	1	42	<b>115,79</b>
<b>62-903-5032-000</b>	50 x 32	10	+90°C	1	40	<b>118,42</b>
<b>62-903-5040-000</b>	50 x 40	10	+90°C	1	40	<b>144,74</b>
<b>62-903-6340-000</b>	63 x 40	10	+90°C	1	18	<b>244,74</b>
<b>62-903-6350-000</b>	63 x 50	10	+90°C	1	18	<b>300,00</b>

## 904

**PERFEKT SYSTEM PLUS**  
 Kolano zaprasowywane GZ

GRUPA RABATOWA

\*) dostępny w III kwartale 2024

**PERFEKT** SYSTEM<sup>+</sup>

indeks	wielkość	PN	Tmax	pakowanie		cena netto [zł]
<b>62-904-1615-000</b>	16 x 1/2"	10	+90°C	5	200	<b>25,76</b>
<b>62-904-1620-000</b>	16 x 3/4"	10	+90°C	5	120	<b>35,80</b>
<b>62-904-1815-000</b>	18 x 1/2"	10	+90°C	5	120	<b>28,50</b>
<b>62-904-2015-000</b>	20 x 1/2"	10	+90°C	2	190	<b>30,45</b>
<b>62-904-2020-000</b>	20 x 3/4"	10	+90°C	2	160	<b>37,60</b>
<b>62-904-2520-000</b>	25 x 3/4"	10	+90°C	5	80	<b>47,88</b>
<b>62-904-2525-000</b>	25 x 1"	10	+90°C	5	80	<b>57,24</b>
<b>62-904-3225-000</b>	32 x 1"	10	+90°C	2	80	<b>89,90</b>

## 905

**PERFEKT SYSTEM PLUS**  
 Kolano zaprasowywane GW

GRUPA RABATOWA

\*) dostępny w III kwartale 2024

**PERFEKT** SYSTEM<sup>+</sup>

indeks	wielkość	PN	Tmax	pakowanie		cena netto [zł]
<b>62-905-1615-000</b>	16 x 1/2"	10	+90°C	5	200	<b>23,56</b>
<b>62-905-2015-000</b>	20 x 1/2"	10	+90°C	6	180	<b>31,26</b>
<b>62-905-2020-000</b>	20 x 3/4"	10	+90°C	6	144	<b>37,00</b>
<b>62-905-2520-000</b>	25 x 3/4"	10	+90°C	6	120	<b>50,68</b>
<b>62-905-2525-000</b>	25 x 1"	10	+90°C	6	120	<b>60,23</b>
<b>62-905-3225-000</b>	32 x 1"	10	+90°C	2	72	<b>81,47</b>

## 906

**PERFEKT SYSTEM PLUS**  
 Kolano zaprasowywane

GRUPA RABATOWA

**PERFEKT** SYSTEM<sup>+</sup>

indeks	wielkość	PN	Tmax	pakowanie		cena netto [zł]
<b>62-906-0160-000</b>	16	10	+90°C	5	160	<b>23,40</b>
<b>62-906-0180-000</b>	18	10	+90°C	8	160	<b>24,00</b>
<b>62-906-0200-000</b>	20	10	+90°C	8	160	<b>31,36</b>
<b>62-906-0250-000</b>	25	10	+90°C	4	80	<b>47,28</b>
<b>62-906-0320-000</b>	32	10	+90°C	2	72	<b>84,97</b>
<b>62-906-0400-000</b>	40	10	+90°C	2	30	<b>139,47</b>
<b>62-906-0500-000</b>	50	10	+90°C	1	24	<b>205,26</b>
<b>62-906-0630-000</b>	63	10	+90°C	1	10	<b>381,58</b>

907

**PERFEKT SYSTEM PLUS**  
 Złączka ślepiąca

GRUPA RABATOWA

**PERFEKT** SYSTEM<sub>+</sub>

indeks	wielkość	PN	Tmax	pakowanie		cena netto [zł]
<b>62-907-0160-000</b>	16 x 1/2"	10	+90°C	20	480	<b>9,80</b>
<b>62-907-0200-000</b>	20 x 3/4"	10	+90°C	20	320	<b>14,70</b>

908

**PERFEKT SYSTEM PLUS**  
 Kolano zaprasowywane  
 z mocowaniem

GRUPA RABATOWA

\*) dostępny w III kwartale 2024

**PERFEKT** SYSTEM<sub>+</sub>

indeks	wielkość	PN	Tmax	pakowanie		cena netto [zł]
<b>62-908-1615-000</b>	16 x 1/2"	10	+90°C	7	168	<b>33,78</b>
<b>62-908-1815-000</b>	18 x 1/2"	10	+90°C	5	80	<b>35,15</b>
<b>62-908-2015-000</b>	20 x 1/2"	10	+90°C	5	80	<b>40,85</b>

909

**PERFEKT SYSTEM PLUS**  
 Trójnik zaprasowywany

GRUPA RABATOWA

\*) dostępny w III kwartale 2024

**PERFEKT** SYSTEM<sub>+</sub>

indeks	wielkość	PN	Tmax	pakowanie		cena netto [zł]
<b>62-909-0160-000</b>	16	10	+90°C	4	144	<b>30,63</b>
<b>62-909-0180-000</b>	18	10	+90°C	2	100	<b>34,50</b>
<b>62-909-0200-000</b>	20	10	+90°C	2	100	<b>39,91</b>
<b>62-909-0250-000</b>	25	10	+90°C	2	48	<b>71,48</b>
<b>62-909-0320-000</b>	32	10	+90°C	4	32	<b>106,00</b>
<b>62-909-0400-000</b>	40	10	+90°C	1	18	<b>202,63</b>
<b>62-909-0500-000</b>	50	10	+90°C	1	12	<b>310,53</b>
<b>62-909-0630-000</b>	63	10	+90°C	1	6	<b>631,58</b>

910

**PERFEKT SYSTEM PLUS**  
 Trójnik zaprasowywany

GRUPA RABATOWA

\*) dostępny w III kwartale 2024

**PERFEKT** SYSTEM<sub>+</sub>

indeks	wielkość	PN	Tmax	pakowanie		cena netto [zł]
<b>62-910-1620-000</b>	16 x 20 x 16	10	+90°C	5	120	<b>38,82</b>
<b>62-910-1816-000</b>	18 x 16 x 16	10	+90°C	5	120	<b>36,80</b>
<b>62-910-1816-180</b>	18 x 16 x 18	10	+90°C	5	120	<b>37,80</b>
<b>62-910-2016-000</b>	20 x 16 x 16	10	+90°C	5	120	<b>38,97</b>
<b>62-910-2016-200</b>	20 x 16 x 20	10	+90°C			<b>38,67</b>
<b>62-910-2018-200</b>	20 x 18 x 20	10	+90°C	5	120	<b>36,10</b>
<b>62-910-2020-000</b>	20 x 20 x 16	10	+90°C	5	100	<b>38,35</b>
<b>62-910-2516-200</b>	25 x 16 x 20	10	+90°C	4	64	<b>41,00</b>
<b>62-910-2516-250</b>	25 x 16 x 25	10	+90°C			<b>64,40</b>
<b>62-910-2518-250</b>	25 x 18 x 25	10	+90°C	4	80	<b>49,80</b>
<b>62-910-2520-200</b>	25 x 20 x 20	10	+90°C	4	64	<b>67,70</b>
<b>62-910-2520-250</b>	25 x 20 x 25	10	+90°C	1	64	<b>59,30</b>
<b>62-910-2525-200</b>	25 x 25 x 20	10	+90°C			<b>69,56</b>
<b>62-910-2532-250</b>	25 x 32 x 25	10	+90°C	5	40	<b>67,64</b>
<b>62-910-3216-320</b>	32 x 16 x 32	10	+90°C	4	48	<b>75,23</b>
<b>62-910-3220-320</b>	32 x 20 x 32	10	+90°C	5	40	<b>100,00</b>
<b>62-910-3225-320</b>	32 x 25 x 32	10	+90°C	2	40	<b>111,10</b>
<b>62-910-4020-400</b>	40 x 20 x 40	10	+90°C	1	21	<b>178,95</b>
<b>62-910-4025-400</b>	40 x 25 x 40	10	+90°C	1	21	<b>181,58</b>
<b>62-910-4032-320</b>	40 x 32 x 32	10	+90°C	1	21	<b>186,84</b>
<b>62-910-4032-400</b>	40 x 32 x 40	10	+90°C	1	21	<b>189,47</b>
<b>62-910-5025-500</b>	50 x 25 x 50	10	+90°C	1	11	<b>271,05</b>
<b>62-910-5032-500</b>	50 x 32 x 50	10	+90°C	1	10	<b>273,68</b>
<b>62-910-5040-500</b>	50 x 40 x 50	10	+90°C	1	10	<b>310,53</b>
<b>62-910-6340-630</b>	63 x 40 x 63	10	+90°C	1	7	<b>547,37</b>
<b>62-910-6350-630</b>	63 x 50 x 63	10	+90°C	1	7	<b>578,95</b>

911

**PERFEKT SYSTEM PLUS**  
 Trójnik zaprasowywany GZ

(G) GRUPA RABATOWA

PERFEKT<sub>SYSTEM</sub>

indeks	wielkość	PN	Tmax	pakowanie		cena netto [zł]
<b>62-911-1615-000</b>	16 x 1/2"	10	+90°C	5	120	<b>39,78</b>
<b>62-911-2015-000</b>	20 x 1/2"	10	+90°C	5	80	<b>47,57</b>
<b>62-911-2020-000</b>	20 x 3/4"	10	+90°C	5	80	<b>58,85</b>
<b>62-911-2520-000</b>	25 x 3/4"	10	+90°C	1	64	<b>71,75</b>
<b>62-911-3225-000</b>	32 x 1"	10	+90°C	1	40	<b>126,40</b>

912

**PERFEKT SYSTEM PLUS**  
 Trójnik zaprasowywany GW

(G) GRUPA RABATOWA

PERFEKT<sub>SYSTEM</sub>

indeks	wielkość	PN	Tmax	pakowanie		cena netto [zł]
<b>62-912-1615-000</b>	16 x 1/2"	10	+90°C	5	120	<b>37,36</b>
<b>62-912-2015-000</b>	20 x 1/2"	10	+90°C	5	120	<b>47,80</b>
<b>62-912-2020-000</b>	20 x 3/4"	10	+90°C	5	80	<b>53,24</b>
<b>62-912-2515-000</b>	25 x 1/2"	10	+90°C	1	72	<b>51,15</b>
<b>62-912-2520-000</b>	25 x 3/4"	10	+90°C	1	64	<b>83,48</b>
<b>62-912-2525-000</b>	25 x 1"	10	+90°C	1	54	<b>91,75</b>
<b>62-912-3225-000</b>	32 x 1"	10	+90°C	3	48	<b>125,50</b>
<b>62-912-4032-000</b>	40 x 1 1/4"	10	+90°C	1	24	<b>207,89</b>
<b>62-912-5040-000</b>	50 x 1 1/2"			1	18	<b>342,11</b>

913

**PERFEKT SYSTEM PLUS**  
 Listwa do baterii

(G) GRUPA RABATOWA

PERFEKT<sub>SYSTEM</sub>

indeks	wielkość	PN	Tmax	pakowanie		cena netto [zł]
<b>62-913-0100-000</b>	16 x 1/2" / 100	10	+90°C	1	15	<b>91,95</b>
<b>62-913-0150-000</b>	16 x 1/2" / 150	10	+90°C	1	15	<b>96,21</b>

\*) dostępny w III kwartale 2024

746

**PERFEKT SYSTEM**  
 Korek zaprasowywany GZ

(G) GRUPA RABATOWA

PERFEKT<sub>SYSTEM</sub>

indeks	wielkość	PN	Tmax	pakowanie		cena netto [zł]
<b>62-746-0160-000</b>	16 x 2,0	10	+90°C	10		<b>7,00</b>
<b>62-746-0200-000</b>	20 x 2,0	10	+90°C	10		<b>10,50</b>

731

**PERFEKT SYSTEM**  
 Nypel zaprasowywany GZ

(G) GRUPA RABATOWA

PERFEKT<sub>SYSTEM</sub>

indeks	wielkość	PN	Tmax	pakowanie		cena netto [zł]
<b>62-731-1615-000</b>	16 x 1/2"	10	+90°C	10	700	<b>15,42</b>
<b>62-731-1620-000</b>	16 x 3/4"	10	+90°C	10	600	<b>19,08</b>
<b>62-731-2015-000</b>	20 x 1/2"	10	+90°C	5	600	<b>19,91</b>
<b>62-731-2020-000</b>	20 x 3/4"	10	+90°C	5	500	<b>20,39</b>
<b>62-731-2515-000</b>	25 x 1/2"	10	+90°C	2	140	<b>35,11</b>
<b>62-731-2520-000</b>	25 x 3/4"	10	+90°C	2	500	<b>41,24</b>
<b>62-731-2525-000</b>	25 x 1"	10	+90°C	2	250	<b>38,19</b>
<b>62-731-3225-000</b>	32 x 1"	10	+90°C	1	150	<b>61,87</b>

732

## PERFEKT SYSTEM

Mufa zaprasowywana GW



GRUPA RABATOWA

PERFEKT<sup>SYSTEM</sup>

indeks	wielkość	PN	Tmax	pakowanie		cena netto [zł]
<b>62-732-1615-000</b>	16 x 1/2"	10	+90°C	10	600	<b>18,99</b>
<b>62-732-1620-000</b>	16 x 3/4"	10	+90°C	5	500	<b>22,94</b>
<b>62-732-2015-000</b>	20 x 1/2"	10	+90°C	5	500	<b>20,81</b>
<b>62-732-2020-000</b>	20 x 3/4"	10	+90°C	5	450	<b>22,91</b>
<b>62-732-2520-000</b>	25 x 3/4"	10	+90°C	2	150	<b>31,95</b>
<b>62-732-2525-000</b>	25 x 1"	10	+90°C	2	250	<b>43,65</b>
<b>62-732-3225-000</b>	32 x 1"	10	+90°C	1	150	<b>64,20</b>

733

## PERFEKT SYSTEM

Złączka zaprasowywana prosta



GRUPA RABATOWA

PERFEKT<sup>SYSTEM</sup>

indeks	wielkość	PN	Tmax	pakowanie		cena netto [zł]
<b>62-733-0160-000</b>	16	10	+90°C	10	220	<b>14,75</b>
<b>62-733-0200-000</b>	20	10	+90°C	5	400	<b>18,49</b>
<b>62-733-0250-000</b>	25	10	+90°C	5	500	<b>32,10</b>
<b>62-733-0320-000</b>	32	10	+90°C	2	250	<b>59,22</b>
<b>62-733-2016-000</b>	20 x 16	10	+90°C	2	400	<b>17,75</b>
<b>62-733-2516-000</b>	25 x 16	10	+90°C	2	160	<b>26,42</b>
<b>62-733-2520-000</b>	25 x 20	10	+90°C	1	150	<b>37,99</b>
<b>62-733-3225-000</b>	32 x 25	10	+90°C	1	150	<b>50,06</b>

734

## PERFEKT SYSTEM

Kolano zaprasowywane GZ



GRUPA RABATOWA

PERFEKT<sup>SYSTEM</sup>

indeks	wielkość	PN	Tmax	pakowanie		cena netto [zł]
<b>62-734-1615-000</b>	16 x 1/2"	10	+90°C	10	500	<b>22,90</b>
<b>62-734-1620-000</b>	16 x 3/4"	10	+90°C	10	350	<b>30,92</b>
<b>62-734-2015-000</b>	20 x 1/2"	10	+90°C	5	350	<b>26,46</b>
<b>62-734-2020-000</b>	20 x 3/4"	10	+90°C	5	280	<b>33,33</b>
<b>62-734-2520-000</b>	25 x 3/4"	10	+90°C	2	150	<b>45,05</b>
<b>62-734-2525-000</b>	25 x 1"	10	+90°C	2	200	<b>47,72</b>
<b>62-734-3225-000</b>	32 x 1"	10	+90°C	1	100	<b>79,62</b>

735

## PERFEKT SYSTEM

Kolano zaprasowywane GW



GRUPA RABATOWA

PERFEKT<sup>SYSTEM</sup>

indeks	wielkość	PN	Tmax	pakowanie		cena netto [zł]
<b>62-735-1615-000</b>	16 x 1/2"	10	+90°C	10	400	<b>20,94</b>
<b>62-735-2015-000</b>	20 x 1/2"	10	+90°C	5	300	<b>27,78</b>
<b>62-735-2020-000</b>	20 x 3/4"	10	+90°C	5	260	<b>32,70</b>
<b>62-735-2520-000</b>	25 x 3/4"	10	+90°C	2	180	<b>41,64</b>
<b>62-735-2525-000</b>	25 x 1"	10	+90°C	2	150	<b>54,83</b>
<b>62-735-3225-000</b>	32 x 1"	10	+90°C	1	100	<b>68,61</b>

736

## PERFEKT SYSTEM

Kolano zaprasowywane



GRUPA RABATOWA

PERFEKT<sup>SYSTEM</sup>

indeks	wielkość	PN	Tmax	pakowanie		cena netto [zł]
<b>62-736-0160-000</b>	16	10	+90°C	10	600	<b>20,84</b>
<b>62-736-0200-000</b>	20	10	+90°C	5	300	<b>27,86</b>
<b>62-736-0250-000</b>	25	10	+90°C	2	150	<b>42,03</b>
<b>62-736-0320-000</b>	32	10	+90°C	1	100	<b>72,32</b>

738

## PERFEKT SYSTEM

Kolano zaprasowywane z mocowaniem



GRUPA RABATOWA

PERFEKT<sup>SYSTEM</sup>

indeks	wielkość	PN	Tmax	pakowanie		cena netto [zł]
<b>62-738-1615-000</b>	16 x 1/2"	10	+90°C	10	240	<b>30,02</b>
<b>62-738-2015-000</b>	20 x 1/2"	10	+90°C	5	220	<b>36,32</b>

739

## PERFEKT SYSTEM

Trójnik zaprasowywany GZ



indeks	wielkość	PN	Tmax	pakowanie		cena netto [zł]
<b>62-739-1615-000</b>	16 x 1/2"	10	+90°C	10	300	<b>33,85</b>
<b>62-739-2015-000</b>	20 x 1/2"	10	+90°C	5	250	<b>40,48</b>
<b>62-739-2020-000</b>	20 x 3/4"	10	+90°C	5	200	<b>50,09</b>
<b>62-739-2520-000</b>	25 x 3/4"	10	+90°C	2	150	<b>67,47</b>
<b>62-739-2525-000</b>	25 x 1"	10	+90°C	2	100	<b>91,95</b>
<b>62-739-3225-000</b>	32 x 1"	10	+90°C	1	90	<b>107,55</b>



GRUPA RABATOWA



73A

## PERFEKT SYSTEM

Trójnik zaprasowywany GW



indeks	wielkość	PN	Tmax	pakowanie		cena netto [zł]
<b>62-071-1615-000</b>	16 x 1/2"	10	+90°C	10	300	<b>31,80</b>
<b>62-071-1620-000</b>	16 x 3/4"	10	+90°C	10	100	<b>32,20</b>
<b>62-071-2015-000</b>	20 x 1/2"	10	+90°C	5	250	<b>40,82</b>
<b>62-071-2020-000</b>	20 x 3/4"	10	+90°C	5	200	<b>44,85</b>
<b>62-071-2520-000</b>	25 x 3/4"	10	+90°C	2	150	<b>70,30</b>
<b>62-071-2525-000</b>	25 x 1"	10	+90°C	2	100	<b>77,26</b>
<b>62-071-3225-000</b>	32 x 1"	10	+90°C	1	90	<b>105,68</b>



GRUPA RABATOWA



73B

## PERFEKT SYSTEM

Trójnik zaprasowywany



indeks	wielkość	PN	Tmax	pakowanie		cena netto [zł]
<b>62-73B-0160-000</b>	16	10	+90°C	10	400	<b>27,21</b>
<b>62-73B-0200-000</b>	20	10	+90°C	5	200	<b>35,48</b>
<b>62-73B-0250-000</b>	25	10	+90°C	2	150	<b>60,19</b>
<b>62-73B-0320-000</b>	32	10	+90°C	1	90	<b>89,15</b>



GRUPA RABATOWA



73C

## PERFEKT SYSTEM

Trójnik zaprasowywany



indeks	wielkość	PN	Tmax	pakowanie		cena netto [zł]
<b>62-73C-1620-000</b>	16 x 20 x 16	10	+90°C	10	300	<b>34,51</b>
<b>62-73C-2016-000</b>	20 x 16 x 16	10	+90°C	5	250	<b>34,58</b>
<b>62-73C-2016-001</b>	20 x 16 x 20	10	+90°C	5	250	<b>34,37</b>
<b>62-73C-2020-000</b>	20 x 20 x 16	10	+90°C	5	250	<b>34,07</b>
<b>62-73C-2025-000</b>	20 x 25 x 20	10	+90°C	2	160	<b>48,86</b>
<b>62-73C-2516-001</b>	25 x 16 x 20	10	+90°C			<b>34,85</b>
<b>62-73C-2516-000</b>	25 x 16 x 25	10	+90°C	2	150	<b>57,23</b>
<b>62-73C-2520-000</b>	25 x 20 x 25	10	+90°C	2	150	<b>51,56</b>
<b>62-73C-2520-001</b>	25 x 20 x 20	10	+90°C	2	150	<b>58,80</b>
<b>62-73C-2525-000</b>	25 x 25 x 20	10	+90°C	2	150	<b>60,48</b>
<b>62-73C-3216-000</b>	32 x 16 x 32	10	+90°C			<b>64,95</b>
<b>62-73C-3220-000</b>	32 x 20 x 32	10	+90°C	1	90	<b>84,22</b>
<b>62-73C-3225-000</b>	32 x 25 x 32	10	+90°C	1	100	<b>93,79</b>



GRUPA RABATOWA



732/O

## PERFEKT SYSTEM

Półśrubunek zaprasowywany



indeks	wielkość	PN	Tmax	pakowanie		cena netto [zł]
<b>62-732-1615-001</b>	16 x 1/2"	10	+90°C	1	300	<b>28,60</b>
<b>62-732-2020-001</b>	20 x 3/4"	10	+90°C	1	250	<b>37,23</b>
<b>62-732-2525-001</b>	25 x 1"	10	+90°C	1	100	<b>48,78</b>



GRUPA RABATOWA



740

## PERFEKT SYSTEM

Listwa do baterii



indeks	wielkość	PN	Tmax	pakowanie		cena netto [zł]
<b>62-740-0100-000</b>	16 x 1/2" x L-100	10	+90°C	1	60	<b>73,56</b>
<b>62-740-0150-000</b>	16 x 1/2" x L-150	10	+90°C	1	60	<b>76,98</b>



GRUPA RABATOWA



741

**PERFEKT SYSTEM**  
Listwa z cyrkulacją  
do baterii

PERFEKT<sup>Q</sup>SYSTEM

indeks	wielkość	PN	Tmax	pakowanie		cena netto [zł]
<b>62-741-0100-000</b>	16 x 1/2" x L-100	10	+90°C	1	60	<b>87,50</b>
<b>62-741-0150-000</b>	16 x 1/2" x L-150	10	+90°C	1	50	<b>90,87</b>



GRUPA RABATOWA

742

**PERFEKT SYSTEM**  
Kolanko  
zaprasowywane typ L  
do grzejnika

PERFEKT<sup>Q</sup>SYSTEM

indeks	wielkość	PN	Tmax	pakowanie		cena netto [zł]
<b>62-742-1615-000</b>	16 x L-200	10	+90°C	1	100	<b>75,01</b>



GRUPA RABATOWA

745

**PERFEKT SYSTEM**  
Zespół kolan  
z mocowaniem z rurką Cu

PERFEKT<sup>Q</sup>SYSTEM

indeks	wielkość	PN	Tmax	pakowanie		cena netto [zł]
<b>62-745-1615-000</b>	16 x L-200	10	+90°C	1	100	<b>125,15</b>



GRUPA RABATOWA

730

**PERFEKT SYSTEM**  
Tuleja do złączek  
zaprasowywanych

PERFEKT<sup>Q</sup>SYSTEM

indeks	wielkość	PN	Tmax	pakowanie		cena netto [zł]
<b>62-730-0160-000</b>	16	10	+90°C	100	800	<b>1,73</b>
<b>62-730-0200-000</b>	20	10	+90°C	50	400	<b>2,11</b>
<b>62-730-0250-000</b>	25	10	+90°C	50	200	<b>5,08</b>



GRUPA RABATOWA

701

**PERFEKT SYSTEM**  
Nypel skręcany GZ

PERFEKT<sup>Q</sup>SYSTEM

indeks	wielkość	PN	Tmax	pakowanie		cena netto [zł]
<b>61-001-1615-000</b>	16 x 1/2"	10	+90°C	10	400	<b>8,12</b>
<b>61-001-2015-000</b>	20 x 1/2"	10	+90°C	5	200	<b>15,26</b>
<b>61-001-2020-000</b>	20 x 3/4"	10	+90°C	5	200	<b>15,83</b>
<b>61-001-2520-000</b>	25 x 3/4"	10	+90°C	2	120	<b>28,74</b>
<b>61-001-2525-000</b>	25 x 1"	10	+90°C	2	100	<b>27,63</b>
<b>61-001-3225-000</b>	32 x 1"	10	+90°C	1	50	<b>38,58</b>



GRUPA RABATOWA

701/B

**PERFEKT SYSTEM**  
Nypel skręcany  
z wymiową końcówką  
do belki rozdzielacza GZ

PERFEKT<sup>Q</sup>SYSTEM

indeks	wielkość	PN	Tmax	pakowanie		cena netto [zł]
<b>61-001-1615-001</b>	16 x 1/2"	10	+90°C	10	100	<b>10,71</b>



GRUPA RABATOWA

702





**PERFEKT SYSTEM**  
Mufa skręcana GW





PERFEKT<sup>Q</sup>SYSTEM





indeks	wielkość	PN	Tmax	pakowanie		cena netto [zł]
<b>61-002-1615-000</b>	16 x 1/2"	10	+90°C	10	400	<b>9,29</b>
<b>61-002-2015-000</b>	20 x 1/2"	10	+90°C	5	200	<b>17,88</b>
<b>61-002-2020-000</b>	20 x 3/4"	10	+90°C	5	200	<b>17,60</b>
<b>61-002-2520-000</b>	25 x 3/4"	10	+90°C	2	100	<b>35,48</b>
<b>61-002-2525-000</b>	25 x 1"	10	+90°C	2	120	<b>42,28</b>
<b>61-002-3225-000</b>	32 x 1"	10	+90°C	1	50	<b>44,08</b>











GRUPA RABATOWA





703		PERFEKT <sup>2</sup> SYSTEM							
PERFEKT SYSTEM		indeks	wielkość	PN	Tmax	pakowanie		cena netto [zł]	
Mufa skręcana									
G	GRUPA RABATOWA		<b>61-003-0160-000</b>	16	10	+90°C	10	200	<b>15,08</b>
		<b>61-003-0200-000</b>	20	10	+90°C	5	160	<b>23,95</b>	
		<b>61-003-1620-000</b>	16 x 20	10	+90°C	5	100	<b>22,10</b>	
		<b>61-003-2520-000</b>	25 x 20	10	+90°C	2	100	<b>35,92</b>	





704		PERFEKT <sup>2</sup> SYSTEM							
PERFEKT SYSTEM		indeks	wielkość	PN	Tmax	pakowanie		cena netto [zł]	
Kolano skręcane GZ									
G	GRUPA RABATOWA		<b>61-004-1615-000</b>	16 x 1/2"	10	+90°C	10	200	<b>12,44</b>
		<b>61-004-2015-000</b>	20 x 1/2"	10	+90°C	5	180	<b>19,81</b>	
		<b>61-004-2020-000</b>	20 x 3/4"	10	+90°C	5	120	<b>21,10</b>	
		<b>61-004-2525-000</b>	25 x 1"	10	+90°C	2	100	<b>37,74</b>	
		<b>61-004-3225-000</b>	32 x 1"	10	+90°C	1	50	<b>49,59</b>	

705		PERFEKT <sup>2</sup> SYSTEM							
PERFEKT SYSTEM		indeks	wielkość	PN	Tmax	pakowanie		cena netto [zł]	
Kolano skręcane GW									
G	GRUPA RABATOWA		<b>61-005-1615-000</b>	16 x 1/2"	10	+90°C	10	200	<b>14,40</b>
		<b>61-005-2015-000</b>	20 x 1/2"	10	+90°C	5	180	<b>23,20</b>	
		<b>61-005-2020-000</b>	20 x 3/4"	10	+90°C	5	120	<b>24,60</b>	
		<b>61-005-2525-000</b>	25 x 1"	10	+90°C	2	100	<b>45,46</b>	
		<b>61-005-3225-000</b>	32 x 1"	10	+90°C	1	50	<b>58,79</b>	

706		PERFEKT <sup>2</sup> SYSTEM							
PERFEKT SYSTEM		indeks	wielkość	PN	Tmax	pakowanie		cena netto [zł]	
Kolano skręcane									
G	GRUPA RABATOWA		<b>61-006-0160-000</b>	16	10	+90°C	10	160	<b>16,98</b>
		<b>61-006-0200-000</b>	20	10	+90°C	5	120	<b>28,85</b>	
		<b>61-006-0250-000</b>	25	10	+90°C	2	80	<b>39,89</b>	
		<b>61-006-2520-000</b>	25 x 20	10	+90°C	2	100	<b>41,96</b>	
		<b>61-006-0320-000</b>	32	10	+90°C	1	50	<b>42,41</b>	

707		PERFEKT <sup>2</sup> SYSTEM							
PERFEKT SYSTEM		indeks	wielkość	PN	Tmax	pakowanie		cena netto [zł]	
Kolano skręcane z mocowaniem GW									
G	GRUPA RABATOWA		<b>61-007-1615-000</b>	16 x 1/2"	10	+90°C	10	120	<b>17,60</b>
		<b>61-007-2015-000</b>	20 x 1/2"	10	+90°C	5	80	<b>25,60</b>	
		<b>61-007-2020-000</b>	20 x 3/4"	10	+90°C	5	80	<b>40,20</b>	

708		PERFEKT <sup>2</sup> SYSTEM							
PERFEKT SYSTEM		indeks	wielkość	PN	Tmax	pakowanie		cena netto [zł]	
Trójnik skręcany GZ									
G	GRUPA RABATOWA		<b>61-008-1615-000</b>	16 x 1/2"	10	+90°C	10	160	<b>19,60</b>
		<b>61-008-2015-000</b>	20 x 1/2"	10	+90°C	5	120	<b>29,03</b>	
		<b>61-008-2020-000</b>	20 x 3/4"	10	+90°C	5	120	<b>36,95</b>	
		<b>61-008-2520-000</b>	25 x 3/4"	10	+90°C	2	60	<b>58,68</b>	
		<b>61-008-2525-000</b>	25 x 1"	10	+90°C	2	50	<b>67,32</b>	
		<b>61-008-3225-000</b>	32 x 1"	10	+90°C	1	50	<b>78,50</b>	

709		PERFEKT <sup>2</sup> SYSTEM							
PERFEKT SYSTEM		indeks	wielkość	PN	Tmax	pakowanie		cena netto [zł]	
Trójnik skręcany GW									
G	GRUPA RABATOWA		<b>61-009-1615-000</b>	16 x 1/2"	10	+90°C	10	160	<b>22,24</b>
		<b>61-009-2015-000</b>	20 x 1/2"	10	+90°C	5	120	<b>35,80</b>	
		<b>61-009-2020-000</b>	20 x 3/4"	10	+90°C	5	80	<b>41,90</b>	
		<b>61-009-2520-000</b>	25 x 3/4"	10	+90°C	2	60	<b>64,09</b>	
		<b>61-009-2525-000</b>	25 x 1"	10	+90°C	1	50	<b>67,32</b>	
		<b>61-009-3225-000</b>	32 x 1"	10	+90°C	2	50	<b>79,01</b>	



## 70A

PERFEKT SYSTEM  
Trójnik skręcanyPERFEKT<sup>2</sup> SYSTEM

indeks	wielkość	PN	Tmax	pakowanie		cena netto [zł]
<b>61-010-0160-000</b>	16	10	+90°C	10	160	<b>22,92</b>
<b>61-010-0200-000</b>	20	10	+90°C	5	80	<b>39,42</b>
<b>61-010-0250-000</b>	25	10	+90°C	2	60	<b>63,26</b>
<b>61-010-0320-000</b>	32	10	+90°C	1	50	<b>79,30</b>
<b>61-010-1616-000</b>	20 x 16 x 16	10	+90°C	5	120	<b>36,47</b>
<b>61-010-1620-000</b>	20 x 16 x 20	10	+90°C	5	100	<b>37,58</b>
<b>61-010-1625-000</b>	25 x 20 x 16	10	+90°C	2	60	<b>54,34</b>
<b>61-010-2520-000</b>	25 x 20 x 25	10	+90°C	2	60	<b>54,11</b>
<b>61-010-3225-000</b>	32 x 25 x 32	10	+90°C	2	50	<b>93,73</b>



GRUPA RABATOWA

## 601

## Nypel skręcany GZ



indeks	wielkość	PN	Tmax	pakowanie		cena netto [zł]
<b>61-601-1615-000</b>	16 x 1/2"	10	+90°C	10	280	<b>7,92</b>
<b>61-601-2015-000</b>	20 x 1/2"	10	+90°C	5	150	<b>12,68</b>
<b>61-601-2020-000</b>	20 x 3/4"	10	+90°C	5	150	<b>14,99</b>
<b>61-601-2520-000</b>	25 x 3/4"	10	+90°C	dostępne w II kwartale		
<b>61-601-2525-000</b>	25 x 1"	10	+90°C	dostępne w II kwartale		



GRUPA RABATOWA

## 602

## Mufa skręcana GW



indeks	wielkość	PN	Tmax	pakowanie		cena netto [zł]
<b>61-602-1615-000</b>	16 x 1/2"	10	+90°C	10	200	<b>9,22</b>
<b>61-602-2015-000</b>	20 x 1/2"	10	+90°C	5	150	<b>12,32</b>
<b>61-602-2020-000</b>	20 x 3/4"	10	+90°C	5	150	<b>15,09</b>
<b>61-602-2520-000</b>	25 x 3/4"	10	+90°C	dostępne w II kwartale		
<b>61-602-2525-000</b>	25 x 1"	10	+90°C	dostępne w II kwartale		



GRUPA RABATOWA

## 603

## Mufa skręcana



indeks	wielkość	PN	Tmax	pakowanie		cena netto [zł]
<b>61-603-0160-000</b>	16	10	+90°C	10	200	<b>14,28</b>
<b>61-603-0200-000</b>	20	10	+90°C	5	150	<b>22,81</b>
<b>61-603-1620-000</b>	20 x 16	10	+90°C	dostępne w II kwartale		



GRUPA RABATOWA

## 604

## Kolano skręcane GZ



indeks	wielkość	PN	Tmax	pakowanie		cena netto [zł]
<b>61-604-1615-000</b>	16 x 1/2"	10	+90°C	10	200	<b>11,54</b>
<b>61-604-2015-000</b>	20 x 1/2"	10	+90°C	5	150	<b>15,75</b>
<b>61-604-2020-000</b>	20 x 3/4"	10	+90°C	5	120	<b>16,95</b>



GRUPA RABATOWA

## 605

## Kolano skręcane GW



indeks	wielkość	PN	Tmax	pakowanie		cena netto [zł]
<b>61-605-1615-000</b>	16 x 1/2"	10	+90°C	10	200	<b>12,60</b>
<b>61-605-2015-000</b>	20 x 1/2"	10	+90°C	5	150	<b>16,53</b>
<b>61-605-2020-000</b>	20 x 3/4"	10	+90°C	5	120	<b>18,98</b>



GRUPA RABATOWA

## 606

## Kolano skręcane



indeks	wielkość	PN	Tmax	pakowanie		cena netto [zł]
<b>61-606-0160-000</b>	16	10	+90°C	10	200	<b>14,90</b>
<b>61-606-0200-000</b>	20	10	+90°C	5	125	<b>21,13</b>
<b>61-606-2525-000</b>	25	10	+90°C	dostępne w II kwartale		



GRUPA RABATOWA

**607**Kolano skręcane  
z mocowaniem GW

indeks	wielkość	PN	Tmax	pakowanie		cena netto [zł]
<b>61-607-1615-000</b>	16 x 1/2"	10	+90°C	10	120	<b>14,53</b>
<b>61-607-2015-000</b>	20 x 1/2"	10	+90°C	5	100	<b>20,75</b>
<b>61-607-2020-000</b>	20 x 3/4"	10	+90°C	dostępne w II kwartale		

**D** GRUPA RABATOWA**608**

Trójnik skręcany GZ



indeks	wielkość	PN	Tmax	pakowanie		cena netto [zł]
<b>61-608-1615-000</b>	16 x 1/2"	10	+90°C	10	120	<b>19,09</b>
<b>61-608-2015-000</b>	20 x 1/2"	10	+90°C	dostępne w II kwartale		
<b>61-608-2020-000</b>	20 x 3/4"	10	+90°C	dostępne w II kwartale		

**D** GRUPA RABATOWA**609**

Trójnik skręcany GW



indeks	wielkość	PN	Tmax	pakowanie		cena netto [zł]
<b>61-609-1615-000</b>	16 x 1/2"	10	+90°C	10	120	<b>20,59</b>
<b>61-609-2015-000</b>	20 x 1/2"	10	+90°C	dostępne w II kwartale		
<b>61-609-2020-000</b>	20 x 3/4"	10	+90°C	dostępne w II kwartale		

**D** GRUPA RABATOWA**60A**

Trójnik skręcany



indeks	wielkość	PN	Tmax	pakowanie		cena netto [zł]
<b>61-610-0160-000</b>	16	10	+90°C	10	120	<b>20,92</b>
<b>61-610-0200-000</b>	20	10	+90°C	5	80	<b>32,56</b>
<b>61-610-1620-000</b>	16 x 20 x 16	10	+90°C	dostępne w II kwartale		
<b>61-610-2016-000</b>	20 x 16 x 20	10	+90°C	5	100	<b>28,77</b>
<b>61-610-2520-000</b>	25 x 20 x 25	10	+90°C	dostępne w II kwartale		
<b>61-610-1616-000</b>	20 x 16 x 16	10	+90°C	dostępne w II kwartale		

**D** GRUPA RABATOWA

w ofercie w II kwartale

**U-P1**Uszczelka do złązek  
zaprasowywanych  
i skręcanych

indeks	wielkość	pakowanie		cena netto [zł]
<b>61-999-0160-000</b>	16	1	1	<b>0,37</b>
<b>61-999-0200-000</b>	20	1	1	<b>0,54</b>
<b>61-999-0250-000</b>	25	1	1	<b>1,07</b>
<b>61-999-0320-000</b>	32	1	1	<b>1,07</b>

**G** GRUPA RABATOWA**PHA-810**Hak podłogowy  
pojedynczy

indeks	wielkość	pakowanie		cena netto [zł]
<b>63-800-0810-000</b>	L-77	100	2500	<b>0,49</b>

**G** GRUPA RABATOWA**PHA-811**Hak podłogowy  
pojedynczy

indeks	wielkość	pakowanie		cena netto [zł]
<b>63-800-0811-000</b>	L-100	100	2500	<b>0,52</b>

**G** GRUPA RABATOWA**PHA-820**Hak podłogowy  
podwójny

indeks	wielkość	pakowanie		cena netto [zł]
<b>63-800-0820-000</b>	L-77	100	2500	<b>0,55</b>

**G** GRUPA RABATOWA

**PHA-821**Hak podłogowy  
podwójny

indeks	wielkość	pakowanie		cena netto [zł]
<b>63-800-0821-000</b>	L-100	100	500	<b>0,58</b>

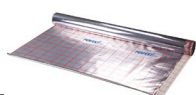
**G** GRUPA RABATOWA**PHA-840**Folia izolacyjna  
przeciwwilgociowa  
do ogrzewania  
podłogowego

indeks	długość rolki	pakowanie		cena netto [zł za m <sup>2</sup> ]
<b>63-800-0840-000</b>	50 m <sup>2</sup>	1	1	<b>4,66</b>

**G** GRUPA RABATOWA**PHA-850**Korek do prób  
szczelności

indeks	wielkość	kolor	pakowanie		cena netto [zł]
<b>63-800-0850-000</b>	½"	czerwony	20	800	<b>1,60</b>

**G** GRUPA RABATOWA**PHA-851**Korek do prób  
szczelności

<b>63-800-0851-000</b>	½"	niebieski	20	800	<b>1,60</b>
------------------------	----	-----------	----	-----	-------------

**G** GRUPA RABATOWA**793**Gradownik do rur  
PERFEKT Pex lub Pert

indeks	wielkość	pakowanie		cena netto [zł]
<b>63-800-2160-000</b>	16	1	1	<b>44,13</b>
<b>63-800-2200-000</b>	20	1	1	<b>50,68</b>
<b>63-800-2250-000</b>	25	1	1	<b>65,40</b>
<b>63-800-2320-000</b>	32	1	1	<b>75,21</b>

**G** GRUPA RABATOWA**N-PRO1**Nożyce profesjonalne do  
cięcia rur PERFEKT SYSTEM  
Pex lub Pert

indeks	pakowanie		cena netto [zł]
<b>63-800-1014-000</b>	1	1	<b>189,24</b>

**G** GRUPA RABATOWA**790**Nożyce do cięcia rur  
PERFEKT SYSTEM  
Pex lub Pert

indeks	pakowanie		cena netto [zł]
<b>63-800-1015-000</b>	1	1	<b>75,70</b>

**G** GRUPA RABATOWA**791/0**Sprężyna do gięcia rur  
PERFEKT SYSTEM  
Pex lub Pert, zewnętrzne

indeks	wielkość	pakowanie		cena netto [zł]
<b>63-700-1600-001</b>	16	1	1	<b>43,11</b>
<b>63-700-2000-001</b>	20	1	1	<b>50,96</b>
<b>63-700-2500-001</b>	25	1	1	<b>82,30</b>
<b>63-700-3200-001</b>	32	1	1	<b>113,68</b>

**G** GRUPA RABATOWA

**792/0**

Sprężyna do gięcia rur  
PERFEKT SYSTEM  
Pex lub Pert, wewnętrzne



indeks	wielkość	pakowanie		cena netto [zł]
<b>63-700-1601-001</b>	16	1	1	<b>23,52</b>
<b>63-700-2001-001</b>	20	1	1	<b>35,26</b>
<b>63-700-2501-001</b>	25	1	1	<b>45,06</b>

**G** GRUPA RABATOWA

**RRP**

Rozwijak  
do rur PERT lub PEX



indeks	ilość rury w kręgu	rodzaj	pakowanie		cena netto [zł]
<b>63-200-0000-000</b>	500m i 600m	większy	1	1	<b>1335,00</b>

**X** GRUPA RABATOWA

**ACO103BT**

Zaciskarka  
bezprzewodowa  
Novopress ACO103  
+cęgi 16,20,25 - zestaw



indeks	pakowanie		cena netto [zł]
<b>63-100-0010-001</b>	1	1	<b>7100,00</b>

**X** GRUPA RABATOWA

**Cęgi zaciskowe**

Cęgi zaciskowe  
do zaciskarki ACO10BT



indeks	wielkość	numer	pakowanie		cena netto [zł]
<b>63-101-0004-160</b>	16	48066-50	1	1	<b>650,00</b>
<b>63-101-0004-200</b>	20	48068-50	1	1	<b>650,00</b>
<b>63-101-0004-250</b>	25	48069-50	1	1	<b>650,00</b>
<b>63-101-0004-320</b>	32	48070-50	1	1	<b>650,00</b>

**X** GRUPA RABATOWA

**82378**

Akumulator M12B4 4,0Ah  
do zaciskarki ACO103



indeks	pakowanie		cena netto [zł]
<b>63-100-0020-001</b>	1	1	<b>550,00</b>

**X** GRUPA RABATOWA

**Cęgi zaciskowe**

Cęgi zaciskowe profil  
U do złączy  
zaprasowywanych



indeks	wielkość	numer	pakowanie		cena netto [zł]
<b>63-000-0002-160</b>	16	570765	1	1	<b>676,50</b>
<b>63-000-0002-200</b>	20	570775	1	1	<b>676,50</b>
<b>63-000-0002-250</b>	25	570780	1	1	<b>676,50</b>
<b>63-000-0002-320</b>	32	570785	1	1	<b>676,50</b>
<b>63-000-0002-400</b>	40	570790	1	1	
<b>63-000-0002-500</b>	50	570795	1	1	
<b>63-000-0002-630</b>	63	572365	1	1	

**X** GRUPA RABATOWA

dostępność i warunki  
u Przedstawicieli Handlowych

**571013**

Zaciskarka  
bezprzewodowa  
Akku-Press



indeks	pakowanie		cena netto [zł]
<b>63-001-0002-000</b>	1	1	<b>6547,20</b>

**X** GRUPA RABATOWA

**578014**

Zaciskarka Mini-Press  
22V ACC Basic-Pack  
R220 L-Boxx



indeks

pakowanie

cena  
netto [zł]**63-001-0016-000**1 1 **7436,00** GRUPA RABATOWA**572111**

Zaciskarka  
przewodowa  
Power-Press SE



indeks

pakowanie

cena  
netto [zł]**63-001-0003-000**1 1 **4092,00** GRUPA RABATOWA**577010**

Zaciskarka  
przewodowa  
Power-Press



indeks

pakowanie

cena  
netto [zł]**63-001-0018-000**1 1 **5800,00** GRUPA RABATOWA**577011**

Zaciskarka  
przewodowa  
Power-Press



indeks

pakowanie

cena  
netto [zł]**63-001-0004-000**1 1 **5053,40** GRUPA RABATOWA**574000**

Zaciskarka ręczna  
Eco-Press



indeks

pakowanie

cena  
netto [zł]**63-001-0005-000**1 1 **671,55** GRUPA RABATOWA**571555**

Akumulator Li-Ion do  
zaciskarki Akku-Press,  
14.4 V, 3.0 Ah



indeks

pakowanie

cena  
netto [zł]**63-001-0008-000**1 1 **1372,80** GRUPA RABATOWA**Cęgi zaciskowe mini U**

Cęgi zaciskowe profil  
U do złączek  
zaprasowywanych



indeks

wielkość

numer

pakowanie

cena  
netto [zł]**63-000-0001-160** 16 578374 1 1 **686,40****63-000-0001-200** 20 578378 1 1 **686,40****63-000-0001-250** 25 578380 1 1 **686,40****63-000-0001-320** 32 578382 1 1 **800,80** GRUPA RABATOWA**571014**

Zaciskarka  
beziprzewodowa  
Akku-Press ACC



indeks

pakowanie

cena  
netto [zł]**63-001-0011-000**1 1 **7207,20** GRUPA RABATOWA

**578012**Zaciskarka  
bezprzewodowa  
Mini-Press ACC

indeks

pakowanie

cena



netto [zł]

**63-001-0017-000**

1 1

**6749,60** GRUPA RABATOWA**578015**Zaciskarka  
bezprzewodowa  
Mini-Press S 22V ACC

indeks

pakowanie

cena



netto [zł]

**63-001-0013-001**

1 1

**7436,00** GRUPA RABATOWA**578010**Zaciskarka  
bezprzewodowa  
Mini-Press 22V ACC

indeks

pakowanie

cena



netto [zł]

**63-001-0006-100**

1 1

**7436,00** GRUPA RABATOWA**571545**Akumulator Li-Ion  
do zaciskarki  
**Mini-Press 578012,**  
14,4 V, 1,5 Ah

indeks

pakowanie

cena



netto [zł]

**63-001-0008-003**

1 1

**972,40** GRUPA RABATOWA**571571**Akumulator Li-Ion  
do zaciskarek  
**Mini-Press 578010 i 578015,**  
21,6 V, 2,5 Ah

indeks

pakowanie

cena



netto [zł]

**63-001-0008-001**

1 1

**1601,60** GRUPA RABATOWA**Posiadamy w ofercie narzędzia dostępne w akcjach promocyjnych  
- szczegóły dostępne u przedstawicieli handlowych.****JL1303**Klucz do rur ze  
szczękami płaskimi

indeks

wielkość

pakowanie

cena



netto [zł]

**90-000-0000-089**

1"

1 1

**65,00** GRUPA RABATOWA**Szczypce uniwersalne  
-kombinerki**

indeks

wielkość

pakowanie

cena



netto [zł]

**90-000-0000-083**

180 mm

1 1

**27,00** GRUPA RABATOWA



### Szczypce wydłużone proste

	indeks	wielkość	pakowanie		cena netto [zł]
					
	<b>90-000-0000-085</b>	200 mm	1	1	<b>27,00</b>

GRUPA RABATOWA

### JL1306

Klucz do rur typ S

	indeks	wielkość	pakowanie		cena netto [zł]
					
	<b>90-000-0000-090</b>	1"	1	1	<b>65,00</b>

GRUPA RABATOWA

### JL1309

Klucz nastawny do rur typu Stillson

	indeks		pakowanie		cena netto [zł]
					
	<b>90-000-0000-093</b>		1	1	<b>70,00</b>

GRUPA RABATOWA

### NWDS-01



Nasadka wielostopniowa do śrubunków

	indeks		pakowanie		cena netto [zł]
					
	<b>90-000-0000-207</b>		1	1	<b>60,00</b>

GRUPA RABATOWA

### UGF1006-PP

Klucz nastawny

	indeks	wielkość	pakowanie		cena netto [zł]
					
	<b>90-000-0001-078</b>	6"	1	1	<b>37,00</b>
	<b>90-000-0001-079</b>	10"	1	1	<b>65,00</b>

GRUPA RABATOWA

### GL9068



Kamera inspekcyjna do rur

	indeks		pakowanie		cena netto [zł]
					
	<b>90-000-0001-080</b>		1	1	<b>850,00</b>

GRUPA RABATOWA

### GT4863

Kabel do kamery inspekcyjnej

	indeks	długość	pakowanie		cena netto [zł]
					
	<b>90-000-0001-089</b>	5 m	1	1	<b>400,00</b>

GRUPA RABATOWA

# PERFEXIM

CENNIK ARMATURA 2024



PERFEKT<sup>2</sup> SYSTEM

- **Niezawodne rozwiązanie w branży HVAC**
- **Zgodna z normą EN12735:1 Miedź i stopy miedzi**
- **Europejski producent**
- **Ochrona zdrowia**

# RURA MIEDZIANA

72-74



## 505

Rura miedziana twarda stan R290

 GRUPA RABATOWA

indeks	wielkość	sztangi 5 m [szt / wiązka m]		cena netto [zł]
<b>70-505-1210-030</b>	12 x 1,0	5	750	<b>z dnia</b>
<b>70-505-1510-030</b>	15 x 1,0	5	500	<b>z dnia</b>
<b>70-505-1810-030</b>	18 x 1,0	5	500	<b>z dnia</b>
<b>70-505-2210-030</b>	22 x 1,0	5	500	<b>z dnia</b>
<b>70-505-2810-030</b>	28 x 1,0	5	500	<b>z dnia</b>
<b>70-505-2815-530</b>	28 x 1,5	5	500	<b>z dnia</b>
<b>70-505-3510-030</b>	35 x 1,0	5	5	<b>z dnia</b>
<b>70-505-3515-530</b>	35 x 1,5	5	5	<b>z dnia</b>
<b>70-505-4215-530</b>	42 x 1,5	5	5	<b>z dnia</b>
<b>70-505-5420-030</b>	54 x 2,0	5	5	<b>z dnia</b>

## 501

Rura miedziana miękka stan R220

 GRUPA RABATOWA

indeks	wielkość	długość [mb]	cena netto [zł]
<b>70-501-1210-030</b>	12 x 1,0	50	<b>z dnia</b>
<b>70-501-1510-030</b>	15 x 1,0	50	<b>z dnia</b>
<b>70-501-1810-030</b>	18 x 1,0	50	<b>z dnia</b>
<b>70-501-2210-030</b>	22 x 1,0	50	<b>z dnia</b>

## 508

CLIMAPLUS rura miedziana miękka R220, w otulinie m.in. do klimatyzacji, gazów chłodniczych

 GRUPA RABATOWA

indeks	wielkość	grubość otuliny [mm]	długość [mb]	cena netto [zł]
<b>70-508-1408-030</b>	¼" x 0,7	6	25	<b>z dnia</b>
<b>70-508-3808-030</b>	¾" x 0,7	7	25	<b>z dnia</b>
<b>70-508-1208-030</b>	½" x 0,7	9	25	<b>z dnia</b>
<b>70-508-5808-030</b>	⅝" x 0,7	9	25	<b>z dnia</b>
<b>70-508-1408-035</b>	¼" x 0,7	6	50	<b>z dnia</b>
<b>70-508-3808-035</b>	¾" x 0,7	7	50	<b>z dnia</b>
<b>70-508-1208-035</b>	½" x 0,7	9	50	<b>z dnia</b>
<b>70-508-5808-035</b>	⅝" x 0,7	9	50	<b>z dnia</b>

## 503

CLIMATUB rura miedziana miękka R220, m.in. do klimatyzacji, celów medycznych

 GRUPA RABATOWA

indeks	wielkość	długość [mb]	cena netto [zł/mb]
<b>70-503-0810-030</b>	8 x 1,0	25	<b>z dnia</b>
<b>70-503-1210-030</b>	12 x 1,0	25	<b>z dnia</b>
<b>70-503-1410-030</b>	14 x 1,0	25	<b>z dnia</b>
<b>70-503-1810-030</b>	18 x 1,0	25	<b>z dnia</b>
<b>70-503-2210-030</b>	22 x 1,0	25	<b>z dnia</b>
<b>70-503-1408-030</b>	¼" x 0,8	15	<b>z dnia</b>
<b>70-503-5168-030</b>	⅝" x 0,8	15	<b>z dnia</b>
<b>70-503-3808-030</b>	¾" x 0,8	15	<b>z dnia</b>
<b>70-503-1208-030</b>	½" x 0,8	15	<b>z dnia</b>
<b>70-503-5808-030</b>	⅝" x 0,8	15	<b>z dnia</b>
<b>70-503-5810-030</b>	⅝" x 1,0	15	<b>z dnia</b>
<b>70-503-3408-030</b>	¾" x 0,8	15	<b>z dnia</b>
<b>70-503-3410-030</b>	¾" x 1,0	15	<b>z dnia</b>
<b>70-503-7810-030</b>	⅞" x 1,0	15	<b>z dnia</b>

507

CLIMATUB rura miedzian  
twarda R290 m.in.  
do klimatyzacji



X GRUPA RABATOWA

indeks	wielkość	długość [mb]		cena netto [zł/mb]
<b>70-507-0810-030</b>	8 x 1.0	5	50	<b>z dnia</b>
<b>70-507-1010-030</b>	10 x 1.0	5	50	<b>z dnia</b>
<b>70-507-1210-030</b>	12 x 1.0	5	50	<b>z dnia</b>
<b>70-507-1510-030</b>	15 x 1.0	5	50	<b>z dnia</b>
<b>70-507-1810-030</b>	18 x 1.0	5	50	<b>z dnia</b>
<b>70-507-2210-030</b>	22 x 1.0	5	50	<b>z dnia</b>
<b>70-507-2810-030</b>	28 x 1.0	5	50	<b>z dnia</b>
<b>70-507-2815-030</b>	28 x 1.5	5	50	<b>z dnia</b>
<b>70-507-3510-030</b>	35 x 1.0	5	50	<b>z dnia</b>
<b>70-507-3515-030</b>	35 x 1.5	5	50	<b>z dnia</b>
<b>70-507-4215-030</b>	42 x 1.5	5	50	<b>z dnia</b>
<b>70-507-5415-030</b>	54 x 1.5	5	50	<b>z dnia</b>
<b>70-507-5420-030</b>	54 x 2.0	5	50	<b>z dnia</b>
<b>70-507-3808-030</b>	¾" x 0.8	5	50	<b>z dnia</b>
<b>70-507-1208-030</b>	½" x 0.8	5	50	<b>z dnia</b>
<b>70-507-5808-030</b>	⅝" x 0.8	5	50	<b>z dnia</b>
<b>70-507-3408-030</b>	¾" x 0.8	5	50	<b>z dnia</b>
<b>70-507-3410-030</b>	¾" x 1.0	5	50	<b>z dnia</b>
<b>70-507-7810-030</b>	⅞" x 1.0	5	50	<b>z dnia</b>
<b>70-507-2510-030</b>	1" x 1.0	5	50	<b>z dnia</b>
<b>70-507-1181-030</b>	1 ⅛" x 1.0	5	50	<b>z dnia</b>
<b>70-507-1381-030</b>	1 ⅜" x 1.25	5	50	<b>z dnia</b>
<b>70-507-1581-030</b>	1 ⅝" x 1.25	5	50	<b>z dnia</b>
<b>70-507-2181-030</b>	2 ⅛" x 1.25	5	50	<b>z dnia</b>
<b>70-507-2186-030</b>	2 ⅛" x 1.65	5	50	<b>z dnia</b>
<b>70-507-2581-030</b>	2 ⅝" x 1.65	5	50	<b>z dnia</b>
<b>70-507-2582-030</b>	2 ⅝" x 2.0	5	50	<b>z dnia</b>
<b>70-507-3181-030</b>	3 ⅛" x 1.65	5	50	<b>z dnia</b>



Ciepło i komfort w domu

# PERFEXIM

CENNIK ARMATURA 2024

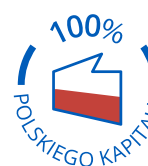

## PERFEKT<sup>2</sup> SYSTEM

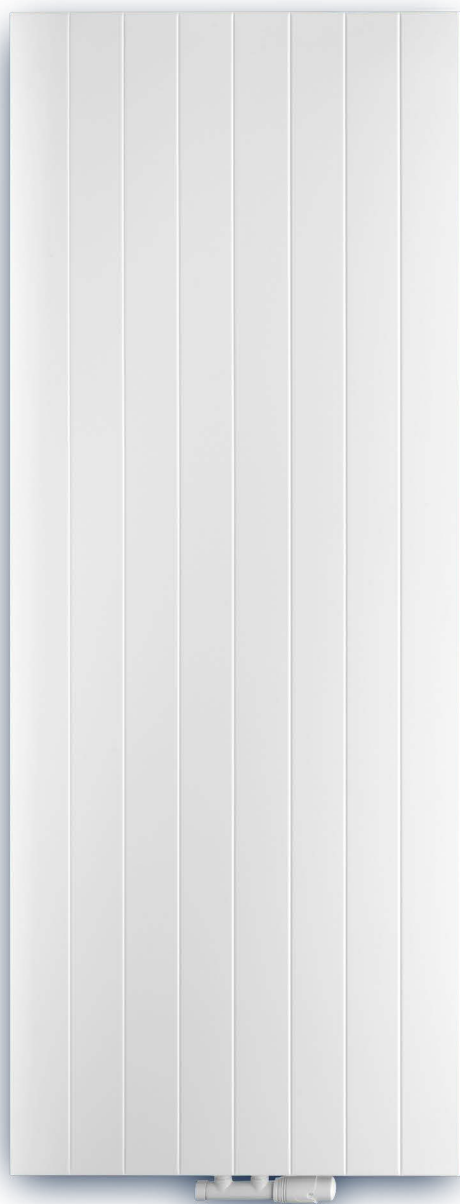

Grzejniki Pionowe **Style Line** powstały z myślą o Klientach ceniących sobie zarówno funkcjonalność jak i nowoczesny design. Poza swoją niezawodną funkcją grzewczą mogą posłużyć również jako modny element wystroju wnętrza, nadając im unikalny charakter. Są dostępne w szerokiej gamie kolorów z palety RAL.

# GRZEJNIKI PŁYTOWE I ALUMINIOWE 75-80

Grzejniki płytowe C i V	76
Grzejniki aluminiowe	78
Osprzęt grzejników aluminiowych	78
Główce termostatyczne	78
Osprzęt grzejników stalowych	80





**CO-350****PERFEKT**  
grzejnik aluminiowy**PERFEKT**<sup>2</sup><sub>SYSTEM</sub>

indeks	wielkość	PN	Tmax	pakowanie		cena netto [zł]
<b>71-000-3500-000</b>	350	16	+95°C	10	500	<b>38,55</b>

**X** GRUPA RABATOWAProdukt dostępny  
do wyczerpania zapasów**PHA-042**Zestaw do podłączenia  
grzejnika aluminiowego**PERFEKT**<sup>2</sup><sub>SYSTEM</sub>

indeks	wielkość	PN	Tmax	pakowanie		cena netto [zł]
<b>71-942-0000-000</b>	1" x 1/2"	10	+110°C	1	50	<b>16,48</b>

**K** GRUPA RABATOWA**NP**Nypel do grzejnika  
aluminiowego

indeks	wielkość	PN	Tmax	pakowanie		cena netto [zł]
<b>71-960-0000-002</b>	1"	10	+110°C	1	500	<b>1,68</b>

**J** GRUPA RABATOWA**UZ**Uszczelka nypla do grzejnika  
aluminiowego

indeks	wielkość	pakowanie		cena netto [zł]
<b>71-960-0000-100</b>	1 mm	1	100	<b>0,33</b>
<b>71-960-0000-101</b>	1,5 mm	1	100	<b>0,35</b>

**J** GRUPA RABATOWA**TRCD10C**Głowica termostatyczna  
cieczowa M30x1.5,  
chromowana

indeks	Tmax	pakowanie		cena netto [zł]
<b>20-107-0400-000</b>	+50°C	1	100	<b>38,23</b>

**E** GRUPA RABATOWA**TRCD10**Głowica termostatyczna  
cieczowa M30x1.5,  
biała

indeks	kolor	Tmax	pakowanie		cena netto [zł]
<b>20-107-0400-100</b>	biały	+50°C	1	100	<b>39,74</b>
<b>20-107-0400-003</b>	czarny mat	+50°C	1	100	<b>37,49</b>

**E** GRUPA RABATOWA

**TRCD15**

Głowica termostatyczna cieczowa M30x1.5 z blokadą nastawy



indeks

Tmax

pakowanie

cena netto [zł]

**20-107-0300-000**

+50°C

1 100

**33,46****E** GRUPA RABATOWA**GS.07**

Głowica termostatyczna cieczowa z przyłączem RA-N do grzejników stalowych typ V

**PERFEKT<sup>2</sup>** SYSTEM

indeks

pakowanie

cena netto [zł]

**20-300-0005-000**

1 100

**68,89****H** GRUPA RABATOWA**GT01RA**

Głowica termostatyczna cieczowa z przyłączem RA z blokadą nastawy temperatury



indeks

Tmax

pakowanie

cena netto [zł]

**20-300-0009-000**

+50°C

1 100

**E** GRUPA RABATOWA

dostępne w III kwartale 2024

**▶ NOWOŚĆ****GT02RA**

Głowica termostatyczna cieczowa z przyłączem RA



indeks

Tmax

pakowanie

cena netto [zł]

**20-300-0010-000**

+50°C

1 100

**E** GRUPA RABATOWA

dostępne w III kwartale 2024

**▶ NOWOŚĆ****GT01**

Głowica termostatyczna cieczowa M30x1.5 z blokadą nastawy



indeks

Tmax

pakowanie

cena netto [zł]

**20-107-0300-003**

+50°C

1 100

**25,30****E** GRUPA RABATOWA

dostępne w III kwartale 2024

**▶ NOWOŚĆ****GT03**

Głowica termostatyczna cieczowa M30x1.5 z blokadą nastawy



indeks

Tmax

pakowanie

cena netto [zł]

**20-107-0300-004**

+50°C

1 100

**25,30****E** GRUPA RABATOWA

dostępne w III kwartale 2024

**▶ NOWOŚĆ****GT04**

Głowica termostatyczna cieczowa M30x1.5 z blokadą nastawy



indeks

Tmax

pakowanie

cena netto [zł]

**20-107-0300-005**

+50°C

1 100

**25,30****E** GRUPA RABATOWA

dostępne w III kwartale 2024

**▶ NOWOŚĆ**

**KM**

Zestaw montażowy do grzejników stalowych typu C



indeks	pakowanie		cena netto [zł]
<b>81-001-0003-000</b>	1	1	<b>12,24</b>

**Z** GRUPA RABATOWA**KDZ**

Konsola do zawieszenia grzejników stalowych typu V



indeks	wielkość	pakowanie		cena netto [zł]
<b>81-000-0300-001</b>	300	1	50	<b>37,92</b>
<b>81-000-0400-001</b>	400	1	50	<b>38,59</b>
<b>81-000-0500-001</b>	500	1	50	<b>39,22</b>
<b>81-000-0600-001</b>	600	1	50	<b>40,93</b>
<b>81-000-0900-001</b>	900	1	50	<b>46,68</b>

**Z** GRUPA RABATOWA**KGH**

Konsola do zawieszenia grzejników stalowych higienicznych



indeks	wielkość	pakowanie		cena netto [zł]
<b>81-000-0300-002</b>	300	1	1	<b>90,32</b>
<b>81-000-0400-002</b>	400	1	1	<b>96,68</b>
<b>81-000-0500-002</b>	500	1	1	<b>100,21</b>
<b>81-000-0600-002</b>	600	1	1	<b>110,79</b>
<b>81-000-0900-002</b>	900	1	1	<b>114,29</b>

**H** GRUPA RABATOWA**KW**

Konsola wolnostojąca do grzejnika stalowego



indeks	wielkość	pakowanie		cena netto [zł]
<b>81-001-0000-000</b>	300-900	1	1	<b>222,29</b>

**Z** GRUPA RABATOWA**OK**

Osłona stopy konsoli wolnostojącej



indeks	pakowanie		cena netto [zł]
<b>81-002-0000-000</b>	1	1	<b>11,83</b>

**Z** GRUPA RABATOWA



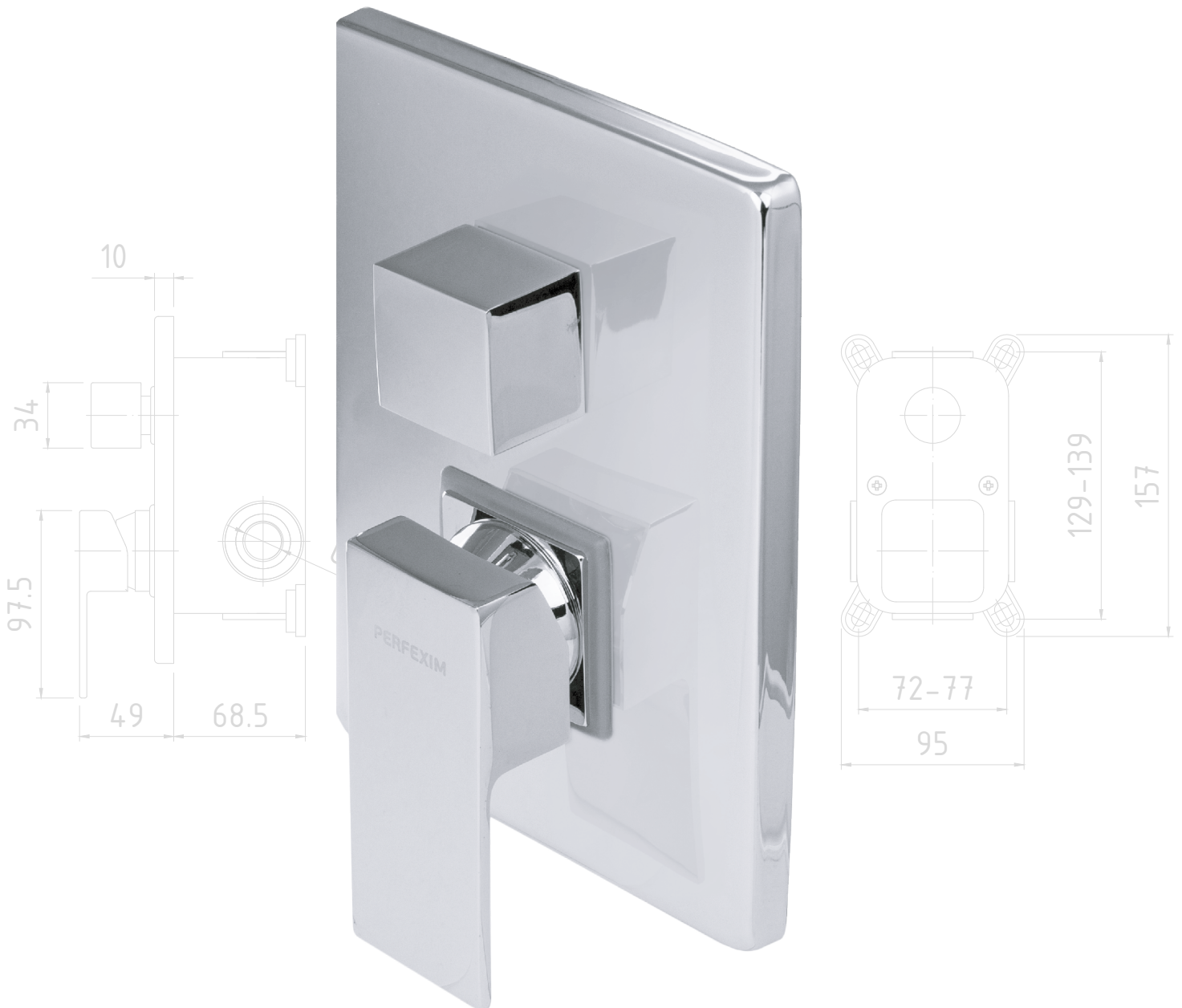

# BATERIE PODTYNKOWE 81-88

Baterie podtynkowe	82
Aksesoria do baterii podtynkowych	86

**SOP04/1P****SOPHIE**

Bateria prysznicowa podtynkowa, wyposażona w box montażowy

I GRUPA RABATOWA  
**GŁOWICA 35**

indeks	pakow. ☐	cena netto [zł]
<b>35-022-0600-000</b>	1	<b>319,60</b>

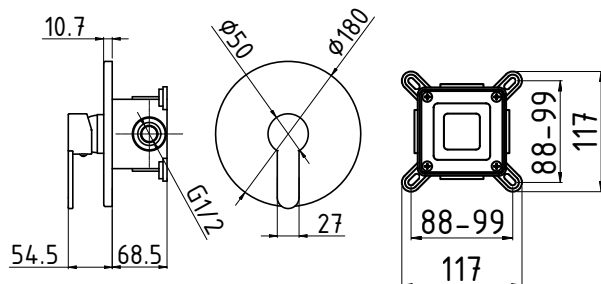
**SOP04/2P****SOPHIE**

Bateria prysznicowa podtynkowa z przełącznikiem prysznic-deszczownia, wyposażona w box montażowy

I GRUPA RABATOWA  
**GŁOWICA 40**

indeks	pakow. ☐	cena netto [zł]
<b>35-022-0600-001</b>	1	<b>514,10</b>

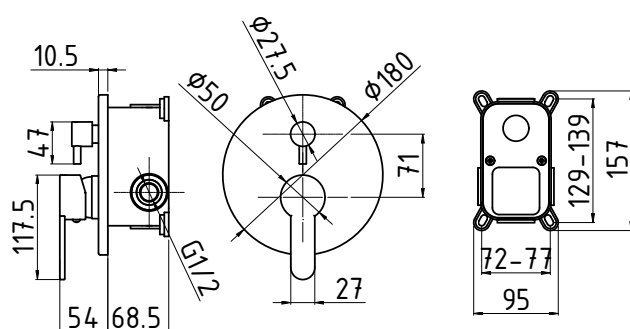

**OLI04/1P****OLIVIA**

Bateria prysznicowa podtynkowa, wyposażona w box montażowy

I GRUPA RABATOWA

**GŁOWICA 35**

indeks	pakow. ☐	cena netto [zł]
<b>35-023-0600-000</b>	<b>1</b>	<b>356,76</b>

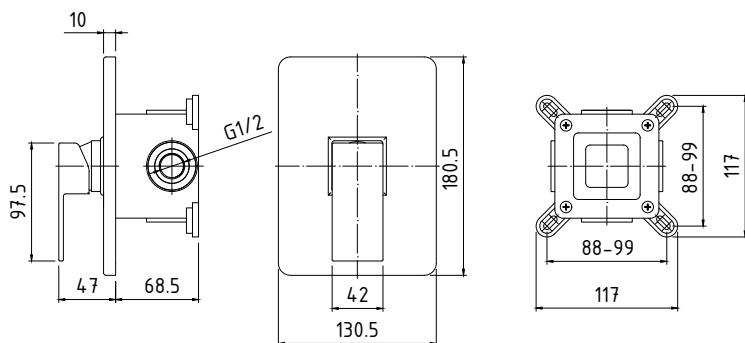
**OLI04/2P****OLIVIA**

Bateria prysznicowa podtynkowa z przełącznikiem prysznic-deszczownia, wyposażona w box montażowy

I GRUPA RABATOWA

**GŁOWICA 35**

indeks	pakow. ☐	cena netto [zł]
<b>35-023-0600-001</b>	<b>1</b>	<b>547,54</b>

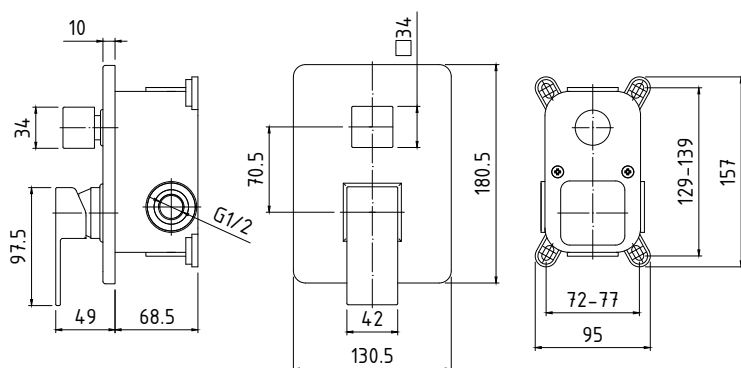

**ROS04/2P****ROSALIA**

Bateria prysznicowa podtynkowa z przełącznikiem prysznic-deszczownia, wyposażona w box montażowy

I GRUPA RABATOWA  
**GŁOWICA 40**

indeks	pakow. ☒	cena netto [zł]
<b>35-024-0600-001</b>	1	<b>590,90</b>

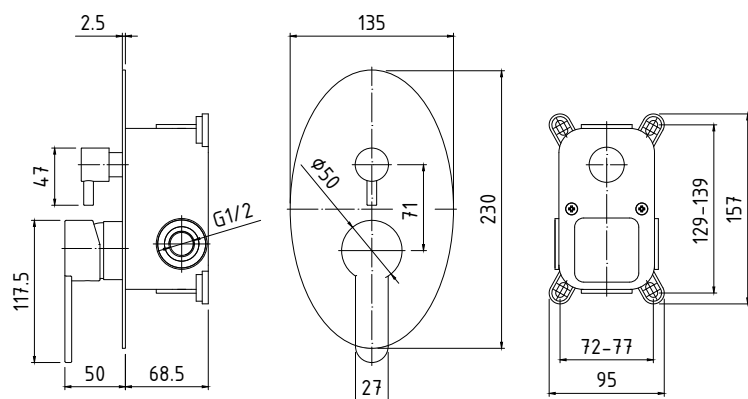
**OLI06****OLIVIA**

Bateria umywalkowa podtynkowa, wyl. stała, wyposażona w box montażowy

I GRUPA RABATOWA  
**GŁOWICA 35**

indeks	pakow. ☒	cena netto [zł]
<b>35-025-0200-000</b>	1	<b>542,57</b>

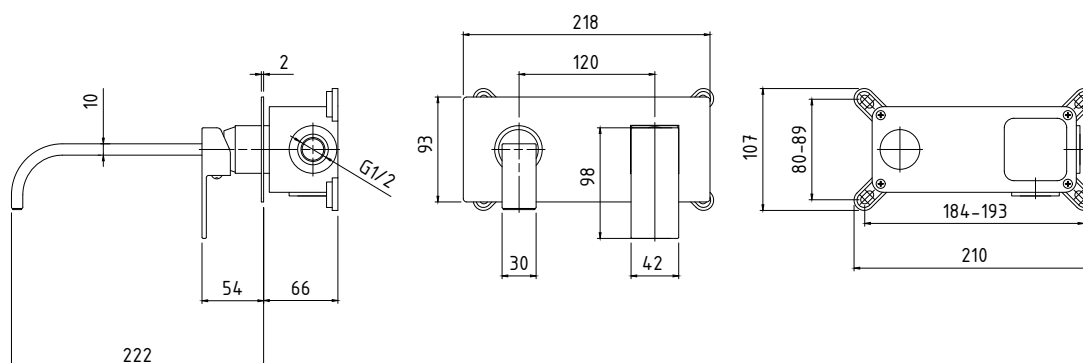

**OLI06-1**

**OLIVIA**

Bateria umywalkowa podtynkowa, wyl. stała,



GRUPA RABATOWA  
**GŁOWICA 35**

indeks	pakow.	cena netto [zł]
<b>35-025-0200-001</b>	1	<b>398,89</b>

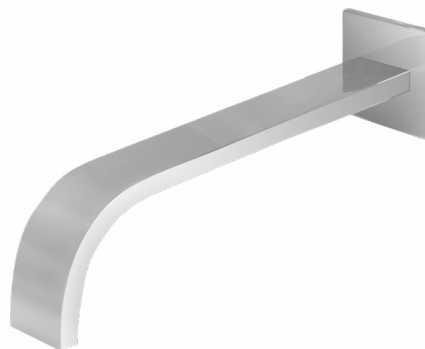
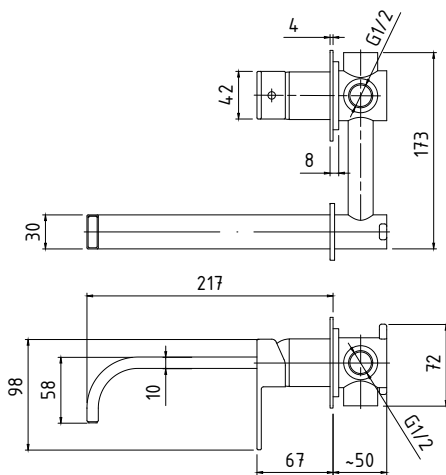

**MAR06-1**

**MARGO**

Bateria umywalkowa podtynkowa, wyl. stała



GRUPA RABATOWA  
**GŁOWICA 35**

indeks	pakow.	cena netto [zł]
<b>35-026-0200-001</b>	1	<b>447,19</b>

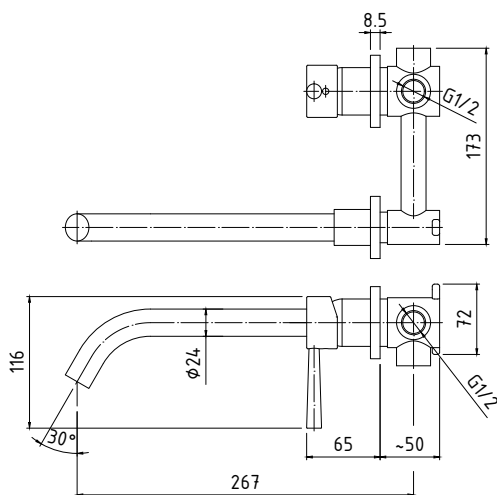

**P12**

Deszczownia PŁASKA  
kwadratowa 300mm x 300mm,  
do baterii podtynkowych



**I** GRUPA RABATOWA

indeks	pakow. ☞	cena netto [zł]
<b>35-202-0002-000</b>	<b>1</b>	<b>192,90</b>

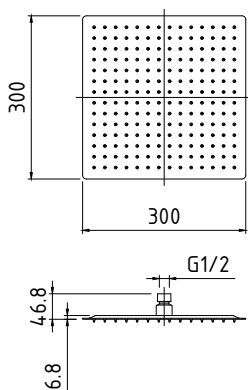
**P13**

Deszczownia PŁASKA  
kwadratowa 400mm x 400mm,  
do baterii podtynkowych



**I** GRUPA RABATOWA

indeks	pakow. ☞	cena netto [zł]
<b>35-202-0002-001</b>	<b>1</b>	<b>379,35</b>

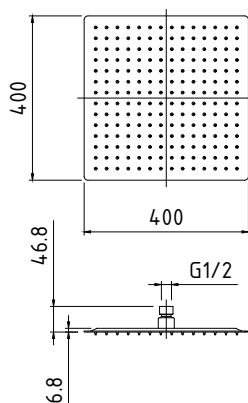
**P14**

Deszczownia PŁASKA okrągła  
Ø 300 mm, (12"), do baterii  
podtynkowych



**I** GRUPA RABATOWA

indeks	pakow. ☞	cena netto [zł]
<b>35-202-0001-000</b>	<b>1</b>	<b>167,17</b>

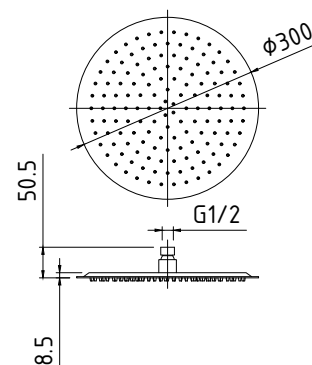
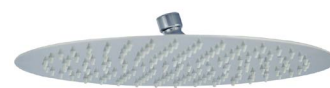
**M1**

Maskownica okrągła Ø 160 mm  
PŁASKA do baterii podtynkowych  
bez przełącznika (dedykowana  
do baterii SOPHIE SOP04/1P)



**I** GRUPA RABATOWA

indeks	pakow. ☞	cena netto [zł]
<b>35-203-0001-000</b>	<b>1</b>	<b>108,01</b>

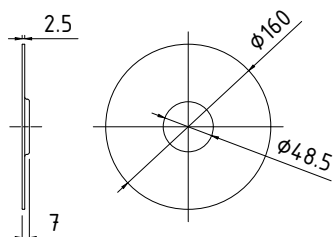
**M2**

Maskownica okrągła Ø 160mm,  
PŁASKA, do baterii podtynkowych  
z przełącznikiem (dedykowana do  
baterii SOPHIE SOP04/2P)



**I** GRUPA RABATOWA

indeks	pakow. ☞	cena netto [zł]
<b>35-203-0001-001</b>	<b>1</b>	<b>108,01</b>

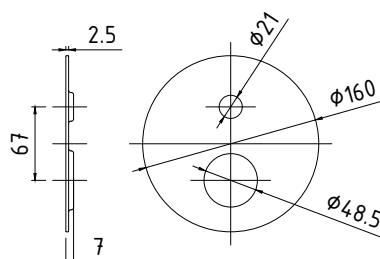
**M3**

Maskownica prostokątna  
120mm x 150mm, PŁASKA, do baterii  
podtynkowych bez przełącznika  
(dedykowana do baterii OLIVIA  
OLI04/1P)



**I** GRUPA RABATOWA

indeks	pakow. ☞	cena netto [zł]
<b>35-203-0000-000</b>	<b>1</b>	<b>102,87</b>

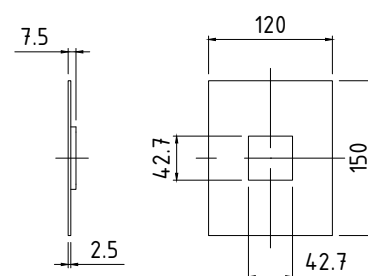
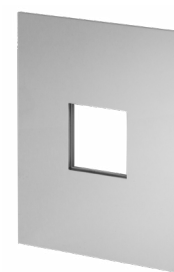

**M4**

Maskownica prostokątna 120mm x 150mm, PŁASKA, do baterii podtynkowych z przełącznikiem (dedykowana do baterii OLIVIA OLI04/2P)



GRUPA RABATOWA

indeks	pakow.	cena netto [zł]
<b>35-203-0000-001</b>	<b>1</b>	<b>108,01</b>

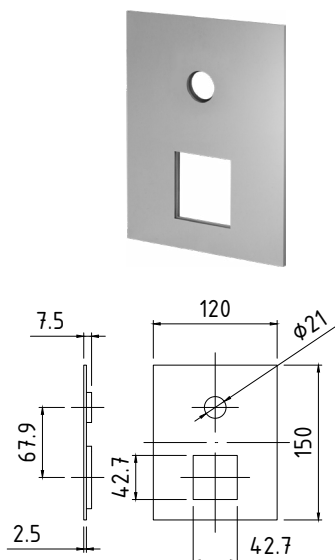
**US1**

Uchwyt zasilający do słuchawki prysznicowej - okrągły, do baterii podtynkowych



GRUPA RABATOWA

indeks	pakow.	cena netto [zł]
<b>35-208-0001-000</b>	<b>1</b>	<b>92,59</b>

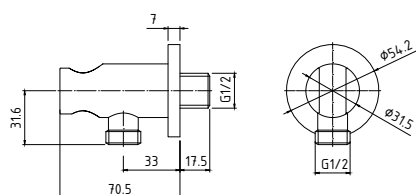
**PW01**

Przyłącze zasilające do węży prysznicowych okrągłe, do baterii podtynkowych



GRUPA RABATOWA

indeks	pakow.	cena netto [zł]
<b>35-206-0001-000</b>	<b>1</b>	<b>57,87</b>

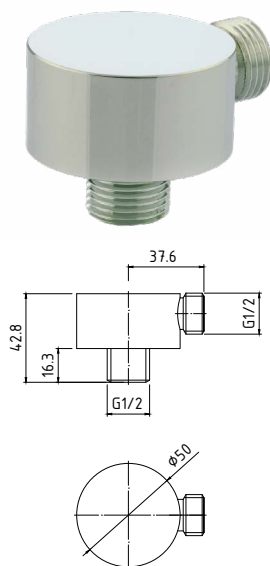
**US2**

Uchwyt zasilający do słuchawki prysznicowej - prostokątny, do baterii podtynkowych



GRUPA RABATOWA

indeks	pakow.	cena netto [zł]
<b>35-208-0002-000</b>	<b>1</b>	<b>92,59</b>

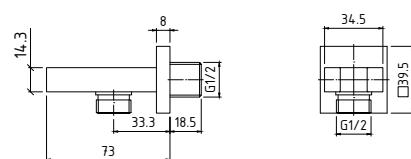
**PW02**

Przyłącze zasilające do węży prysznicowych kwadrat, do baterii podtynkowych



GRUPA RABATOWA

indeks	pakow.	cena netto [zł]
<b>35-206-0002-000</b>	<b>1</b>	<b>61,72</b>

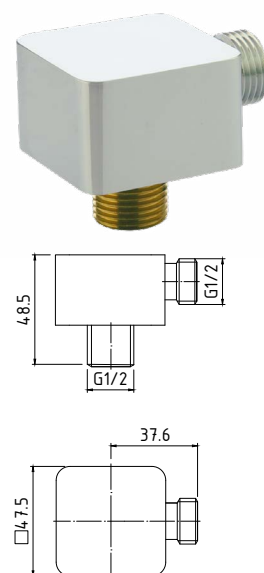
**R11**

Ramię prysznicowe poziome profil prostokątny 30x15mm, długość 400mm, do baterii podtynkowych



GRUPA RABATOWA

indeks	pakow.	cena netto [zł]
<b>35-207-0003-000</b>	<b>1</b>	<b>120,88</b>

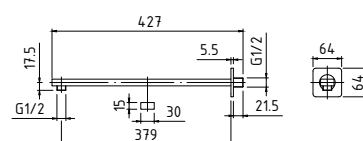

**R12**

Ramię prysznicowe poziome  
profil prostokątny 30x15mm,  
długość 500mm, do baterii  
podtynkowych



**I** GRUPA RABATOWA

indeks	pakow. ☐	cena netto [zł]
<b>35-207-0003-001</b>	<b>1</b>	<b>160,75</b>

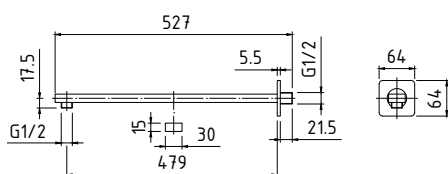
**R13**

Ramię prysznicowe poziome  
profil kwadrat 24x24mm,  
długość 400mm, do baterii  
podtynkowych



**I** GRUPA RABATOWA

indeks	pakow. ☐	cena netto [zł]
<b>35-207-0002-000</b>	<b>1</b>	<b>154,31</b>

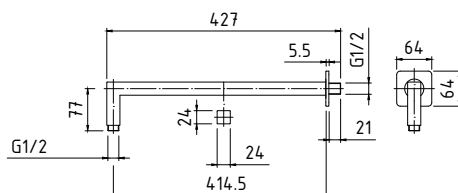
**R14**

Ramię prysznicowe poziome  
profil kwadrat 24x24mm,  
długość 500mm, do baterii  
podtynkowych



**I** GRUPA RABATOWA

indeks	pakow. ☐	cena netto [zł]
<b>35-207-0002-001</b>	<b>1</b>	<b>180,04</b>

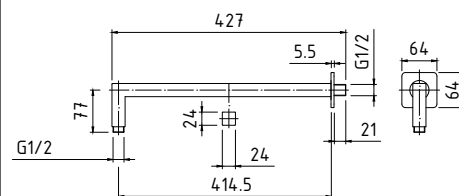
**R15**

Ramię prysznicowe poziome  
profil okrągły Ø 22, długość  
400mm, do baterii  
podtynkowych



**I** GRUPA RABATOWA

indeks	pakow. ☐	cena netto [zł]
<b>35-207-0001-000</b>	<b>1</b>	<b>102,87</b>

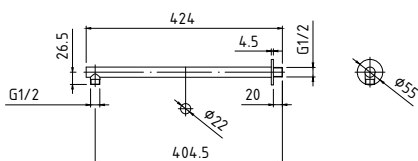
**R16**

Ramię prysznicowe poziome  
profil okrągły Ø 22, długość  
500mm, do baterii  
podtynkowych



**I** GRUPA RABATOWA

indeks	pakow. ☐	cena netto [zł]
<b>35-207-0001-001</b>	<b>1</b>	<b>122,17</b>

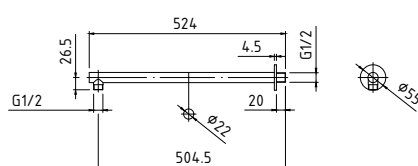





Serie klasycznych baterii łazienkowych oraz kuchennych, w których  
**TRADYCJA ŁĄCZY SIĘ Z NOWOCZESNOŚCIĄ**



# ARMATURA KUCHENNA I ŁAZIENKOWA 89-123

Baterie WEGA	90
Baterie RENO	92
Baterie kuchenne i łazienkowe	94
głowica 40	94
głowica 35	98
Baterie ciśnieniowe	108
Syfony	108
Korki zamykające	109
Komplety prysznicowe	114
Słuchawki z deszczownicą	115
Słuchawki	116
Drażki prysznicowe	119
Uchwyty punktowe	120
Wężę prysznicowe	121
Akcesoria łazienkowe z przyssawką	122

**84401****WEGA**

Bateria umywalkowa stojąca



GŁOWICA 35



GRUPA RABATOWA

**NEXE**  
new line

indeks	kolor	pakow. ☐	cena netto [zł]
<b>36-018-0300-003</b>	czarny mat	1	<b>283,62</b>

**84401-1****WEGA**Bateria umywalkowa stojąca  
nablatowa

GŁOWICA 35



GRUPA RABATOWA

**NEXE**  
new line

indeks	kolor	pakow. ☐	cena netto [zł]
<b>36-018-0310-003</b>	czarny mat	1	<b>584,60</b>

**84402****WEGA**

Bateria bidetowa stojąca



GŁOWICA 35



GRUPA RABATOWA

**NEXE**  
new line

indeks	kolor	pakow. ☐	cena netto [zł]
<b>36-018-0700-003</b>	czarny mat	1	<b>300,98</b>

**84403****WEGA**

Bateria wannowa naścienna



GŁOWICA 35



GRUPA RABATOWA

**NEXE**  
new line

indeks	kolor	pakow. ☐	cena netto [zł]
<b>36-018-0000-003</b>	czarny mat	1	<b>387,81</b>

**84404****WEGA**

Bateria prysznicowa naścienna



GŁOWICA 35



GRUPA RABATOWA

**NEXE**  
new line

indeks	kolor	pakow. ☐	cena netto [zł]
<b>36-018-0600-003</b>	czarny mat	1	<b>297,51</b>

**84405****WEGA**Bateria zlewozmywakowa  
stojąca

GŁOWICA 35



GRUPA RABATOWA

**NEXE**  
new line

indeks	kolor	pakow. ☐	cena netto [zł]
<b>36-018-0500-003</b>	czarny mat	1	<b>457,26</b>



**84404-11****WEGA**  
Deszczownia z baterią  
natryskową naścienna

GŁOWICA 35

**(N)** GRUPA RABATOWA**NEXE**  
new line

indeks	kolor	pakow.	cena netto [zł]
36-018-1600-003	czarny mat	1	1146,05

**84409-1****WEGA**  
Bateria prysznicowa  
podtynkowa

GŁOWICA 35

**(N)** GRUPA RABATOWA**NEXE**  
new line

indeks	kolor	pakow.	cena netto [zł]
36-018-0621-000	czarny mat	1	792,75

**84405****WEGA**  
Bateria zlewozmywakowa  
stojąca

GŁOWICA 35

**(N)** GRUPA RABATOWA**NEXE**  
new line

indeks	kolor	pakow.	cena netto [zł]
36-018-0500-001	biała	1	457,26

**84401****WEGA**  
Bateria umywalkowa stojąca

GŁOWICA 35

**(N)** GRUPA RABATOWA**NEXE**  
new line

indeks	kolor	pakow.	cena netto [zł]
36-018-0300-000	chrom	1	272,04

**84401-1****WEGA**  
Bateria umywalkowa stojąca  
nablatowa

GŁOWICA 35

**(N)** GRUPA RABATOWA**NEXE**  
new line

indeks	kolor	pakow.	cena netto [zł]
36-018-0310-000	chrom	1	530,20

**84402****WEGA**  
Bateria bidetowa stojąca

GŁOWICA 35

**(N)** GRUPA RABATOWA**NEXE**  
new line

indeks	kolor	pakow.	cena netto [zł]
36-018-0700-000	chrom	1	285,94



**84403****WEGA**

Bateria wannowa naścienna



GŁOWICA 35

**(N)** GRUPA RABATOWA**NEXE**  
new line

indeks	kolor	pakow. ☐	cena netto [zł]
<b>36-018-0000-000</b>	chrom	1	<b>346,13</b>

**84404****WEGA**

Bateria prysznicowa naścienna



GŁOWICA 35

**(N)** GRUPA RABATOWA**NEXE**  
new line

indeks	kolor	pakow. ☐	cena netto [zł]
<b>36-018-0600-000</b>	chrom	1	<b>260,46</b>

**84405****WEGA**

Bateria zlewozmywakowa stojąca



GŁOWICA 35

**(N)** GRUPA RABATOWA**NEXE**  
new line

indeks	kolor	pakow. ☐	cena netto [zł]
<b>36-018-0500-000</b>	chrom	1	<b>399,38</b>

**84404-11****WEGA**

Deszczownia z baterią natryskową naścienną



GŁOWICA 35

**(N)** GRUPA RABATOWA**NEXE**  
new line

indeks	kolor	pakow. ☐	cena netto [zł]
<b>36-018-1600-000</b>	chrom	1	<b>850,86</b>

**84409-1****WEGA**

Bateria prysznicowa podtynkowa



GŁOWICA 35

**(N)** GRUPA RABATOWA**NEXE**  
new line

indeks	kolor	pakow. ☐	cena netto [zł]
<b>36-018-0621-000</b>	chrom	1	<b>690,90</b>

**85501****RENO**

Bateria umywalkowa stojąca



GŁOWICA 35

**(N)** GRUPA RABATOWA**NEXE**  
new line

indeks	kolor	pakow. ☐	cena netto [zł]
<b>36-017-0300-000</b>		1	<b>262,78</b>



**85501-1****RENO**  
Bateria umywalkowa stojąca  
nablatowa

GŁOWICA 35

**(N)** GRUPA RABATOWA**NEXE**  
new line

indeks	pakow. ☐	cena netto [zł]
<b>36-017-0310-000</b>	1	<b>575,34</b>

**85502****RENO**  
Bateria bidetowa stojąca

GŁOWICA 35

**(N)** GRUPA RABATOWA**NEXE**  
new line

indeks	pakow. ☐	cena netto [zł]
<b>36-017-0700-000</b>	1	<b>274,35</b>

**85503****RENO**  
Bateria wannowa naścienna

GŁOWICA 35

**(N)** GRUPA RABATOWA**NEXE**  
new line

indeks	pakow. ☐	cena netto [zł]
<b>36-017-0000-000</b>	1	<b>366,96</b>

**85504****RENO**  
Bateria prysznicowa naścienna

GŁOWICA 35

**(N)** GRUPA RABATOWA**NEXE**  
new line

indeks	pakow. ☐	cena netto [zł]
<b>36-017-0600-000</b>	1	<b>320,66</b>



**CAR07**

**CARLO**  
bateria zlewozmywakowa  
wysoka stojąca



GŁOWICA 40

**I** GRUPA RABATOWA

indeks	pakow. 	cena netto <sup>[zł]</sup>
<b>35-015-0500-001</b>	1 10	<b>173,41</b>

**CAR05/22**

**CARLO**  
bateria zlewozmywakowa  
stojąca



GŁOWICA 40

**I** GRUPA RABATOWA

indeks	wyl. [cm]	pakow. 	cena netto <sup>[zł]</sup>
<b>35-015-0500-000</b>	22	1 10	<b>143,68</b>

**CAR06/22**

**CARLO**  
bateria zlewozmywakowa  
naścienna



GŁOWICA 40

**I** GRUPA RABATOWA

indeks	wyl. [cm]	pakow. 	cena netto <sup>[zł]</sup>
<b>35-015-0400-000</b>	22	1 10	<b>206,93</b>

**CAR03**

**CARLO**  
bateria wannowa naścienna  
bez akcesoriów



GŁOWICA 40

**I** GRUPA RABATOWA

indeks	pakow. 	cena netto <sup>[zł]</sup>
<b>35-015-0000-000</b>	1 10	<b>240,11</b>

**CAR06/18**

**CARLO**  
bateria umywalkowa  
naścienna



GŁOWICA 40

**I** GRUPA RABATOWA

indeks	wyl. [cm]	pakow. 	cena netto <sup>[zł]</sup>
<b>35-015-0200-000</b>	18	1 10	<b>203,78</b>



**CAR04**

**CARLO**  
bateria prysznicowa  
naścienna bez akcesoriów



GŁOWICA 40

**I** GRUPA RABATOWA

indeks	pakow. 	cena netto <sup>[zł]</sup>
<b>35-015-0600-000</b>	1 10	<b>186,40</b>

**CAR01**

**CARLO**  
bateria umywalkowa  
stojąca



GŁOWICA 40

**I** GRUPA RABATOWA

indeks	pakow. 	cena netto <sup>[zł]</sup>
<b>35-015-0100-000</b>	1 10	<b>175,32</b>

**CAR02**

**CARLO**  
bateria bidetowa



GŁOWICA 40

**I** GRUPA RABATOWA

indeks	pakow. 	cena netto <sup>[zł]</sup>
<b>35-015-0700-000</b>	1 10	<b>172,20</b>

**363**

**DALIA**  
bateria zlewozmywakowa  
stojąca



GŁOWICA 40

**I** GRUPA RABATOWA

indeks	wyl. [cm]	pakow. 	cena netto <sup>[zł]</sup>
<b>35-010-0500-000</b>	22	1 10	<b>123,99</b>

**316**

**DALIA**  
bateria zlewozmywakowa  
naścienna



GŁOWICA 40

**I** GRUPA RABATOWA

indeks	wyl. [cm]	pakow. 	cena netto <sup>[zł]</sup>
<b>35-010-0400-000</b>	22	1 10	<b>182,46</b>



**354****DALIA**  
bateria wannowa naścienna

GŁOWICA 40

GRUPA RABATOWA

indeks	pakow. 	cena netto <sup>[zł]</sup>
<b>35-010-0000-000</b>	1 10	<b>256,87</b>

**316****DALIA**  
bateria umywalkowa  
naścienna

GŁOWICA 40

GRUPA RABATOWA

indeks	wyl. [cm]	pakow. 	cena netto <sup>[zł]</sup>
<b>35-010-0200-001</b>	18	1 10	<b>180,66</b>

**315****DALIA**  
bateria prysznicowa  
naścienna

GŁOWICA 40

GRUPA RABATOWA

indeks	pakow. 	cena netto <sup>[zł]</sup>
<b>35-010-0600-000</b>	1 10	<b>194,85</b>

**361****DALIA**  
bateria umywalkowa  
stojąca

GŁOWICA 40

GRUPA RABATOWA

indeks	pakow. 	cena netto <sup>[zł]</sup>
<b>35-010-0100-000</b>	1 10	<b>152,34</b>

**362****DALIA**  
bateria bidetowa

GŁOWICA 40

GRUPA RABATOWA

indeks	pakow. 	cena netto <sup>[zł]</sup>
<b>35-010-0700-000</b>	1 10	<b>159,44</b>





**163****MALWA**  
bateria zlewozmywakowa  
stożąca

GŁOWICA 40

GRUPA RABATOWA

indeks	wyl. [cm]	pakow. 	cena netto [zł]
<b>35-008-0500-001</b>	16	1 10	<b>161,27</b>
<b>35-008-0500-000</b>	22	1 10	<b>161,27</b>

**163/1****MALWA**  
bateria zlewozmywakowa  
stożąca ze skośną wylewką

GŁOWICA 40

GRUPA RABATOWA

indeks	wyl. [cm]	pakow. 	cena netto [zł]
<b>35-008-0500-002</b>		1 10	<b>146,33</b>

**166****MALWA**  
bateria zlewozmywakowa  
naścienna

GŁOWICA 40

GRUPA RABATOWA

indeks	wyl. [cm]	pakow. 	cena netto [zł]
<b>35-008-0400-000</b>	22	1 10	<b>222,21</b>

**164****MALWA**  
bateria wannowa naścienna

GŁOWICA 40

GRUPA RABATOWA

indeks	pakow. 	cena netto [zł]
<b>35-008-0000-000</b>	1 10	<b>277,76</b>

**166****MALWA**  
bateria umywalkowa  
naścienna

GŁOWICA 40

GRUPA RABATOWA

indeks	wyl. [cm]	pakow. 	cena netto [zł]
<b>35-008-0200-000</b>	18	1 10	<b>218,63</b>



**165****MALWA**  
bateria prysznicowa  
naścienna

GŁOWICA 40

GRUPA RABATOWA

indeks	pakow. 	cena netto <sup>[zł]</sup>
<b>35-008-0600-000</b>	1 10	<b>232,97</b>

**161****MALWA**  
bateria umywalkowa  
stojąca

GŁOWICA 40

GRUPA RABATOWA

indeks	pakow. 	cena netto <sup>[zł]</sup>
<b>35-008-0100-000</b>	1 10	<b>182,78</b>

**162****MALWA**  
bateria bidetowa

GŁOWICA 40

GRUPA RABATOWA

indeks	pakow. 	cena netto <sup>[zł]</sup>
<b>35-008-0700-000</b>	1 10	<b>197,12</b>

**FAB07****FABIO**  
bateria zlewozmywakowa  
stojąca wysoka

GŁOWICA 40

GRUPA RABATOWA

indeks	pakow. 	cena netto <sup>[zł]</sup>
<b>35-016-0500-001</b>	1 12	<b>194,39</b>

**COR07****CORNELIA**  
bateria zlewozmywakowa  
stojąca wysoka

GŁOWICA 35

GRUPA RABATOWA

indeks	pakow. 	cena netto <sup>[zł]</sup>
<b>35-017-0500-001</b>	1 10	<b>267,73</b>

**ANG05/22****ANGELA**  
bateria zlewozmywakowa stojąca

GŁOWICA 35

GRUPA RABATOWA

indeks	wylewka [cm]	pakow. 	cena netto <sup>[zł]</sup>
<b>35-011-0500-000</b>	22	1 10	<b>137,11</b>



**ANG06/22****ANGELA**

bateria zlewozmywakowa naścienna



GŁOWICA 35

I GRUPA RABATOWA

indeks	wylewka [cm]	pakow. 	cena netto [zł]
35-011-0400-000	22	1 10	219,07

**ANG04****ANGELA**

bateria prysznicowa bez akcesoriów



GŁOWICA 35

I GRUPA RABATOWA

indeks	pakow. 	cena netto [zł]
35-011-0600-000	1 10	196,74

**ANG01****ANGELA**

bateria umywalkowa stojąca



GŁOWICA 35

I GRUPA RABATOWA

indeks	pakow. 	cena netto [zł]
35-011-0100-000	1 10	173,00

**ANG02****ANGELA**

bateria bidetowa



GŁOWICA 35

I GRUPA RABATOWA

indeks	pakow. 	cena netto [zł]
35-011-0700-000	1 10	177,35

**BIA04****BIANCA**

bateria prysznicowa bez akcesoriów



GŁOWICA 35

I GRUPA RABATOWA

indeks	pakow. 	cena netto [zł]
35-012-0600-000	1 10	203,23

**BIA01****BIANCA**

bateria umywalkowa stojąca



GŁOWICA 35

I GRUPA RABATOWA

indeks	pakow. 	cena netto [zł]
35-012-0100-000	1 10	212,90



**ANG03**

**ANGELA**  
bateria wannowa bez  
akcesoriów



GŁOWICA 35

**I** GRUPA RABATOWA

indeks	pakow. 	cena netto <sup>[zł]</sup>
<b>35-011-0000-000</b>	1 12	<b>244,39</b>

**ANG06/18**

**ANGELA**  
bateria umywalkowa  
naścienna



GŁOWICA 35

**I** GRUPA RABATOWA

indeks	wyl. [cm]	pakow. 	cena netto <sup>[zł]</sup>
<b>35-011-0200-000</b>	18	1 10	<b>216,10</b>

**BIA05/22**

**BIANCA**  
bateria zlewozmywakowa  
stojąca



GŁOWICA 35

**I** GRUPA RABATOWA

indeks	wyl. [cm]	pakow. 	cena netto <sup>[zł]</sup>
<b>35-012-0500-000</b>	22	1 10	<b>137,58</b>

**BIA06/22**

**BIANCA**  
bateria zlewozmywakowa  
naścienna



GŁOWICA 35

**I** GRUPA RABATOWA

indeks	wyl. [cm]	pakow. 	cena netto <sup>[zł]</sup>
<b>35-012-0400-000</b>	22	1 10	<b>231,01</b>



**BIA03****BIANCA**bateria wannowa bez  
akcesoriów

GŁOWICA 35

I GRUPA RABATOWA

indeks	pakow. ☐ ☐	cena netto [zł]
35-012-0000-000	1 10	273,43

**BIA06/18****BIANCA**bateria umywalkowa  
naścienna

GŁOWICA 35

I GRUPA RABATOWA

indeks	wyl. [cm]	pakow. ☐ ☐	cena netto [zł]
35-012-0200-000	18	1 10	228,10

**ENR03****ENRICA**bateria wannowa bez  
akcesoriów

GŁOWICA 35

I GRUPA RABATOWA

indeks	pakow. ☐ ☐	cena netto [zł]
35-013-0000-000	1 10	219,32

**ENR06/18****ENRICA**bateria umywalkowa  
naścienna

GŁOWICA 35

I GRUPA RABATOWA

indeks	wyl. [cm]	pakow. ☐ ☐	cena netto [zł]
35-013-0200-000	18	1 10	191,54



**BIA02****BIANCA**

bateria bidetowa



GŁOWICA 35

**I** GRUPA RABATOWA

indeks	pakow. 	cena netto [zł]
<b>35-012-0700-000</b>	1 10	<b>209,10</b>

**ENR07****ENRICA**

bateria zlewozmywakowa stojąca wysoka



GŁOWICA 35

**I** GRUPA RABATOWA

indeks	pakow. 	cena netto [zł]
<b>35-013-0500-001</b>	1 10	<b>174,26</b>

**ENR05/16**  
**ENR05/22****ENRICA**  
bateria zlewozmywakowa stojąca

GŁOWICA 35

**I** GRUPA RABATOWA

indeks	wyl. [cm]	pakow. 	cena netto [zł]
<b>35-013-0501-000</b>	16	1 10	<b>127,21</b>
<b>35-013-0500-000</b>	22	1 10	<b>132,98</b>

**ENR06/22****ENRICA**

bateria zlewozmywakowa naścienna



GŁOWICA 35

**I** GRUPA RABATOWA

indeks	wyl. [cm]	pakow. 	cena netto [zł]
<b>35-013-0400-000</b>	22	1 10	<b>194,47</b>

**ENR04****ENRICA**

bateria prysznicowa bez akcesoriów



GŁOWICA 35

**I** GRUPA RABATOWA

indeks	pakow. 	cena netto [zł]
<b>35-013-0600-000</b>	1 10	<b>176,91</b>

**ENR01****ENRICA**

bateria umywalkowa stojąca



GŁOWICA 35

**I** GRUPA RABATOWA

indeks	pakow. 	cena netto [zł]
<b>35-013-0100-000</b>	1 10	<b>162,27</b>



**ENR02****ENRICA**  
bateria bidetowa

GŁOWICA 35

GRUPA RABATOWA

indeks	pakow. 	cena netto [zł]
<b>35-013-0700-000</b>	1 10	<b>159,39</b>

**1004****IRYS**  
bateria prysznicowa  
naścienna

GŁOWICA 35

GRUPA RABATOWA

indeks	pakow. 	cena netto [zł]
<b>35-001-0600-000</b>	1 12	<b>241,82</b>

**1001-I  
1001-I/BS****IRYS**  
bateria umywalkowa  
stojąca z/bez spustu

GŁOWICA 35

GRUPA RABATOWA

indeks	spust	pakow. 	cena netto [zł]
<b>35-001-0100-001</b>	tak	1 12	<b>169,12</b>
<b>35-001-0100-002</b>	nie	1 12	<b>158,17</b>

**1005****IRYS**  
bateria zlewozmywakowa  
stojąca

GŁOWICA 35

GRUPA RABATOWA

indeks	wyl. [cm]	pakow. 	cena netto [zł]
<b>35-001-0500-000</b>	16	1 10	<b>171,15</b>
<b>35-001-0501-000</b>	22	1 10	<b>171,15</b>

**1006****IRYS**  
bateria zlewozmywakowa  
naścienna

GŁOWICA 35

GRUPA RABATOWA

indeks	wyl. [cm]	pakow. 	cena netto [zł]
<b>35-001-0400-000</b>	22	1 12	<b>245,56</b>



**1003****IRYS**  
bateria wannowa naścienna

GŁOWICA 35

GRUPA RABATOWA

indeks	pakow. 	cena netto <sup>[zł]</sup>
<b>35-001-0000-000</b>	1 12	<b>279,05</b>

**1006/1****IRYS**  
bateria umywalkowa naścienna

GŁOWICA 35

GRUPA RABATOWA

indeks	wyl. [cm]	pakow. 	cena netto <sup>[zł]</sup>
<b>35-001-0200-000</b>	18	1 10	<b>239,99</b>
<b>35-001-0201-000</b>	14	1 10	<b>234,41</b>

**1002****IRYS**  
bateria bidetowa

GŁOWICA 35

GRUPA RABATOWA

indeks	pakow. 	cena netto <sup>[zł]</sup>
<b>35-001-0700-000</b>	1 10	<b>184,07</b>

**LAU07****LAURA**  
bateria zlewozmywakowa stojąca wysoka

GŁOWICA 35

GRUPA RABATOWA

indeks	pakow. 	cena netto <sup>[zł]</sup>
<b>35-014-0500-001</b>	1 10	<b>179,01</b>

**LAU05/22****LAURA**  
bateria zlewozmywakowa stojąca

GŁOWICA 35

GRUPA RABATOWA

indeks	wyl. [cm]	pakow. 	cena netto <sup>[zł]</sup>
<b>35-014-0500-000</b>	22	1 10	<b>135,82</b>





**LAU06/22****LAURA**  
bateria zlewozmywakowa  
naścienna

GŁOWICA 35

GRUPA RABATOWA

indeks	wyl. [cm]	pakow. 	cena netto [zł]
<b>35-014-0400-000</b>	22	1 10	<b>196,34</b>

**LAU04****LAURA**  
bateria prysznicowa bez  
akcesoriów

GŁOWICA 35

GRUPA RABATOWA

indeks	wyl. [cm]	pakow. 	cena netto [zł]
<b>35-014-0600-000</b>		1 10	<b>178,62</b>

**LAU01****LAURA**  
bateria umywalkowa  
stojąca

GŁOWICA 35

GRUPA RABATOWA

indeks	wyl. [cm]	pakow. 	cena netto [zł]
<b>35-014-0100-000</b>		1 10	<b>168,34</b>

**LAU02****LAURA**  
bateria bidetowa

GŁOWICA 35

GRUPA RABATOWA

indeks	wyl. [cm]	pakow. 	cena netto [zł]
<b>35-014-0700-000</b>		1 10	<b>160,92</b>

**902/B****LILIA**  
bateria zlewozmywakowa  
stojąca

GŁOWICA 35

GRUPA RABATOWA

indeks	wyl. [cm]	pakow. 	cena netto [zł]
<b>35-003-0500-000</b>	22	1 10	<b>171,15</b>

**903/B****LILIA**  
bateria zlewozmywakowa  
naścienna

GŁOWICA 35

GRUPA RABATOWA

indeks	wyl. [cm]	pakow. 	cena netto [zł]
<b>35-003-0400-000</b>	22	1 12	<b>245,56</b>



**1015****LILIA**

bateria wannowa naścienna



GŁOWICA 35

I GRUPA RABATOWA

indeks	pakow. 	cena netto [zł]
<b>35-003-0000-000</b>	1 12	<b>279,05</b>

**2015****LILIA**bateria prysznicowa  
naścienna

GŁOWICA 35

I GRUPA RABATOWA

indeks	pakow. 	cena netto [zł]
<b>35-003-0600-000</b>	1 12	<b>241,82</b>

**LAU03****LAURA**bateria wannowa bez  
akcesoriów

GŁOWICA 35

I GRUPA RABATOWA

indeks	pakow. 	cena netto [zł]
<b>35-014-0000-000</b>	1 10	<b>225,87</b>

**LAU06/18****LAURA**bateria umywalkowa  
naścienna

GŁOWICA 35

I GRUPA RABATOWA

indeks	wyl. [cm]	pakow. 	cena netto [zł]
<b>35-014-0200-000</b>	18	1 10	<b>193,38</b>

**903/B****LILIA**bateria umywalkowa  
naścienna

GŁOWICA 35

I GRUPA RABATOWA

indeks	wyl. [cm]	pakow. 	cena netto [zł]
<b>35-003-0200-000</b>	16	1 12	<b>239,99</b>



**3015-I**  
**3015-I/BS****LILIA**  
bateria umywalkowa  
stożąca z/bez spustu

GŁOWICA 35

**I** GRUPA RABATOWA

indeks	spust	pakow. ☐ ☐	cena netto [zł]
<b>35-003-0100-001</b>	tak	1 12	<b>169,12</b>
<b>35-003-0100-002</b>	nie	1 12	<b>158,17</b>

**7003****MAK**  
bateria wannowa naścienna**I** GRUPA RABATOWA

indeks	pakow. ☐ ☐	cena netto [zł]
<b>35-000-0000-000</b>	1 10	<b>290,25</b>

**4015****LILIA**  
bateria bidetowa

GŁOWICA 35

**I** GRUPA RABATOWA

indeks	pakow. ☐ ☐	cena netto [zł]
<b>35-003-0700-000</b>	1 10	<b>189,75</b>

**7004****MAK**  
bateria prysznicowa  
naścienna**I** GRUPA RABATOWA

indeks	pakow. ☐ ☐	cena netto [zł]
<b>35-000-0600-000</b>	1 20	<b>217,79</b>

**7007-1 / 7007-2****MAK**  
bateria umywalkowa  
naścienna jednotworowa  
typ C/typ S**I** GRUPA RABATOWA

indeks	wyl. [mm]	pakow. ☐ ☐	cena netto [zł]
<b>35-000-0002-000</b>	18 C	2 40	<b>75,46</b>
<b>35-000-0003-000</b>	18 S	2 40	<b>75,46</b>

**7005****MAK**  
bateria zlewomywakowa  
stożąca**I** GRUPA RABATOWA

indeks	pakow. ☐ ☐	cena netto [zł]
<b>35-000-0502-000</b>	1 10	<b>164,35</b>



**7006 / 7006/1****MAK**  
bateria umywalkowa naścienna**I** GRUPA RABATOWA

indeks	wyl. [cm]	typ	symbol	pak.	cena netto [zł]
<b>35-000-0200-000</b>	18	C	7006	1 10	<b>180,92</b>
<b>35-000-0201-000</b>	18	S	7006	1 10	<b>180,92</b>
<b>35-000-0400-000</b>	22	C	7006-1	1 10	<b>185,98</b>
<b>35-000-0401-000</b>	22	S	7006-1	1 10	<b>185,98</b>

**S2**Zawór ciśnieniowy  
spłukujący czasowy**N** GRUPA RABATOWA**NEXE**  
new line

indeks	pakow.	cena netto [zł]
<b>35-501-0002-000</b>	1	<b>193,53</b>

**S3**Bateria ciśnieniowa  
umywalkowa czasowa**N** GRUPA RABATOWA**NEXE**  
new line

indeks	pakow.	cena netto [zł]
<b>35-501-0003-000</b>	1	<b>157,27</b>

**SYMISO**

Syfon mosiężny okrągły

**N** GRUPA RABATOWA**NEXE**  
new line

indeks	kolor	pakow.	cena netto [zł]
<b>36-200-0000-000</b>	chrom	1 1	<b>142,37</b>
<b>36-200-0000-003</b>	czarny mat	1 1	<b>203,39</b>
<b>36-200-0000-006</b>	złoty	1 1	<b>203,39</b>
<b>36-200-0000-007</b>	różowe złoto	1 1	<b>203,39</b>



chrom



czarny mat



złoty

różowe  
złoto**S4**Bateria ciśnieniowa  
umywalkowa czasowa**N** GRUPA RABATOWA**NEXE**  
new line

indeks	pakow.	cena netto [zł]
<b>35-501-0004-000</b>	1	<b>157,27</b>

**SYMKS**

Syfon mosiężny kwadratowy

**N** GRUPA RABATOWA**NEXE**  
new line

indeks	kolor	pakow.	cena netto [zł]
<b>36-220-0000-000</b>	chrom	1 1	<b>165,25</b>
<b>36-220-0000-001</b>	biały	1 1	<b>241,52</b>
<b>36-220-0000-003</b>	czarny mat	1 1	<b>241,52</b>
<b>36-220-0000-006</b>	złoty	1 1	<b>241,52</b>
<b>36-220-0000-007</b>	różowe złoto	1 1	<b>241,52</b>



chrom



złoty



biały

różowe  
złoto

czarny mat

**SPPMWK****CLICK-CLACK**

G1¼ z przelewem, wysoki z  
koszem, przycisk duży,  
okrągły, wypukły

(N) GRUPA RABATOWA

**NEXE**  
new line

indeks	kolor	pakow. ☐ ☐	cena netto [zł]
<b>36-300-0000-000</b>	chrom	1 1	<b>74,95</b>
<b>36-300-0000-003</b>	czarny mat	1 1	<b>74,95</b>
<b>36-300-0000-006</b>	złoty	1 1	<b>74,95</b>
<b>36-300-0000-007</b>	różowe złoto	1 1	<b>74,95</b>



chrom



złoty



czarny mat

różowe  
złoto**SPPMWK****CLICK-CLACK**

G1¼ z przelewem, wysoki z  
koszem, przycisk duży,  
okrągły, płaski

(N) GRUPA RABATOWA

**NEXE**  
new line

indeks	kolor	pakow. ☐ ☐	cena netto [zł]
<b>36-300-0010-000</b>	chrom	1 1	<b>74,95</b>
<b>36-300-0010-001</b>	biały	1 1	<b>74,95</b>
<b>36-300-0010-003</b>	czarny mat	1 1	<b>74,95</b>
<b>36-300-0010-006</b>	złoty	1 1	<b>74,95</b>
<b>36-300-0010-007</b>	różowe złoto	1 1	<b>74,95</b>



chrom



złoty



biały

różowe  
złoto

czarny mat

**SPPMK****CLICK-CLACK**

G1¼ z przelewem, wysoki z  
koszem, przycisk  
kwadratowy, wypukły

(N) GRUPA RABATOWA

**NEXE**  
new line

indeks	kolor	pakow. ☐ ☐	cena netto [zł]
<b>36-300-0020-000</b>	chrom	1 1	<b>78,52</b>
<b>36-300-0020-001</b>	biały	1 1	<b>78,52</b>
<b>36-300-0020-003</b>	czarny mat	1 1	<b>78,52</b>
<b>36-300-0020-006</b>	złoty	1 1	<b>78,52</b>
<b>36-300-0020-007</b>	różowe złoto	1 1	<b>78,52</b>



chrom



złoty



biały

różowe  
złoto

czarny mat

**SPPMK****CLICK-CLACK**

G1¼ z przelewem, z koszem,  
przycisk duży, okrągły,  
wypukły

(N) GRUPA RABATOWA

**NEXE**  
new line

indeks	kolor	pakow. ☐ ☐	cena netto [zł]
<b>36-300-1000-000</b>	chrom	1 1	<b>74,95</b>
<b>36-300-1000-001</b>	biały	1 1	<b>74,95</b>
<b>36-300-1000-003</b>	czarny mat	1 1	<b>74,95</b>
<b>36-300-1000-006</b>	złoty	1 1	<b>74,95</b>
<b>36-300-1000-007</b>	różowe złoto	1 1	<b>74,95</b>



chrom



złoty



biały

różowe  
złoto

czarny mat



**SPPMK****CLICK-CLACK**G1¼ z przelewem, z koszem,  
przycisk duży, okrągły, płaski**(N)** GRUPA RABATOWA**NEXE**  
new line

indeks	kolor	pakow. ☐ ☐	cena netto [zł]
<b>36-300-1010-000</b>	chrom	1 1	<b>74,95</b>
<b>36-300-1010-001</b>	biały	1 1	<b>74,95</b>
<b>36-300-1010-003</b>	czarny mat	1 1	<b>74,95</b>
<b>36-300-1010-006</b>	złoty	1 1	<b>74,95</b>
<b>36-300-1010-007</b>	różowe złoto	1 1	<b>74,95</b>



chrom



złoty



biały

różowe  
złoto

czarny mat

**SPPMW****CLICK-CLACK**G1¼ z przelewem, wysoki  
przycisk duży okrągły  
wypukły**(N)** GRUPA RABATOWA**NEXE**  
new line

indeks	kolor	pakow. ☐ ☐	cena netto [zł]
<b>36-400-0000-000</b>	chrom	1 1	<b>71,39</b>
<b>36-400-0000-001</b>	biały	1 1	<b>71,39</b>
<b>36-400-0000-003</b>	czarny mat	1 1	<b>71,39</b>



chrom



biały



czarny mat

**SPPMW****CLICK-CLACK**G1¼ z przelewem, wysoki  
przycisk duży okrągły płaski**(N)** GRUPA RABATOWA**NEXE**  
new line

indeks	kolor	pakow. ☐ ☐	cena netto [zł]
<b>36-400-0010-000</b>	chrom	1 1	<b>71,39</b>
<b>36-400-0010-003</b>	czarny mat	1 1	<b>71,39</b>



chrom



czarny mat

**SPPMW****CLICK-CLACK**G1¼ z przelewem, wysoki  
przycisk kwadratowy wypukły**(N)** GRUPA RABATOWA**NEXE**  
new line

indeks	kolor	pakow. ☐ ☐	cena netto [zł]
<b>36-400-0020-000</b>	chrom	1 1	<b>76,15</b>
<b>36-400-0020-003</b>	czarny mat	1 1	<b>76,15</b>



chrom



czarny mat



**SPPM****CLICK-CLACK**G1¼ z przelewem, przycisk  
duży okrągły wypukły**(N)** GRUPA RABATOWA**NEXE**  
new line

indeks	kolor	pakow. ☐ ☐	cena netto [zł]
<b>36-400-1000-000</b>	chrom	1 1	<b>71,39</b>
<b>36-400-1000-001</b>	biały	1 1	<b>71,39</b>
<b>36-400-1000-003</b>	czarny mat	1 1	<b>71,39</b>



chrom



biały



czarny mat

**SPPM****CLICK-CLACK**G1¼ z przelewem, przycisk  
duży okrągły płaski**(N)** GRUPA RABATOWA**NEXE**  
new line

indeks	kolor	pakow. ☐ ☐	cena netto [zł]
<b>36-400-1010-000</b>	chrom	1 1	<b>71,39</b>
<b>36-400-1010-003</b>	czarny mat	1 1	<b>71,39</b>



chrom



czarny mat

**SPPM****CLICK-CLACK**G1¼ z przelewem, przycisk  
kwadratowy wypukły**(N)** GRUPA RABATOWA**NEXE**  
new line

indeks	kolor	pakow. ☐ ☐	cena netto [zł]
<b>36-400-1020-000</b>	chrom	1 1	<b>76,15</b>
<b>36-400-1020-003</b>	czarny mat	1 1	<b>76,15</b>



chrom



czarny mat

**SPMWK****CLICK-CLACK**G1¼ bez przelewu, wysoki, z  
koszem, przycisk duży  
okrągły, wypukły**(N)** GRUPA RABATOWA**NEXE**  
new line

indeks	kolor	pakow. ☐ ☐	cena netto [zł]
<b>36-310-0000-000</b>	chrom	1 1	<b>74,95</b>
<b>36-310-0000-001</b>	biały	1 1	<b>79,72</b>
<b>36-310-0000-003</b>	czarny mat	1 1	<b>79,72</b>



chrom



biały



czarny mat



**SPMWK****CLICK-CLACK**

G1¼ bez przelewu, wysoki, z koszem, przycisk duży okrągły, płaski

(N) GRUPA RABATOWA

**NEXE**  
new line

indeks	kolor	pakow. ☐ ☐	cena netto [zł]
<b>36-310-0010-000</b>	chrom	1 1	<b>73,77</b>
<b>36-310-0010-003</b>	czarny mat	1 1	<b>73,77</b>



chrom



czarny mat

**SPMWK****CLICK-CLACK**

G1¼ bez przelewu, wysoki, z koszem, przycisk kwadratowy, wypukły

(N) GRUPA RABATOWA

**NEXE**  
new line

indeks	kolor	pakow. ☐ ☐	cena netto [zł]
<b>36-310-0020-000</b>	chrom	1 1	<b>76,15</b>
<b>36-310-0020-003</b>	czarny mat	1 1	<b>76,15</b>



chrom



czarny mat

**SPPMWK****CLICK-CLACK**

G1¼ z przelewem, wysoki, z koszem, przycisk ceramiczny duży, okrągły, wypukły

(N) GRUPA RABATOWA

**NEXE**  
new line

indeks	kolor	pakow. ☐ ☐	cena netto [zł]
<b>36-300-0040-001</b>	biały	1 1	<b>80,90</b>
<b>36-300-0040-005</b>	czarny	1 1	<b>80,90</b>



biały



czarny

**SPPT01E****CLICK-CLACK**

G1¼ z przelewem, przycisk duży okrągły wypukły chromowany

(N) GRUPA RABATOWA

**NEXE**  
new line

indeks	kolor	pakow. ☐ ☐	cena netto [zł]
<b>36-500-1000-000</b>	biały	1 1	<b>20,34</b>





**SPPT05E****CLICK-CLACK**

G1¼ z przelewem, przycisk mały okrągły płaski chromowany

**(N)** GRUPA RABATOWA

**NEXE**  
new line

indeks	kolor	pakow. ☐ ☐	cena netto [zł]
<b>36-500-1050-000</b>	biały	1 1	<b>18,80</b>

**PR04**

Przycisk ceramiczny, duży okrągły, wypukły

**(N)** GRUPA RABATOWA

**NEXE**  
new line

indeks	kolor	pakow. ☐ ☐	cena netto [zł]
<b>36-140-0000-001</b>	biały	1 1	<b>22,04</b>
<b>36-140-0000-005</b>	czarny	1 1	<b>22,04</b>



biały



czarny

**SPPTB01****CLICK-CLACK**

G1¼ z przelewem, z blokadą przycisk duży okrągły wypukły chromowany

**(N)** GRUPA RABATOWA

**NEXE**  
new line

indeks	kolor	pakow. ☐ ☐	cena netto [zł]
<b>36-500-1000-100</b>	czarny	1 1	<b>20,23</b>

**PR01**

Przycisk mosiężny okrągły, wypukły

**(N)** GRUPA RABATOWA

**NEXE**  
new line

indeks	kolor	pakow. ☐ ☐	cena netto [zł]
<b>36-130-0000-000</b>	chrom	1 1	<b>20,81</b>
<b>36-130-0000-001</b>	biały	1 1	<b>20,81</b>
<b>36-130-0000-003</b>	czarny mat	1 1	<b>20,81</b>
<b>36-130-0000-006</b>	złoty	1 1	<b>20,81</b>
<b>36-130-0000-007</b>	różowe złoto	1 1	<b>20,81</b>



chrom



złoty



biały



różowe złoto



czarny mat



**PR02**Przycisk mosiężny  
okrągły, płaski**(N)** GRUPA RABATOWA**NEXE**  
new line

indeks	kolor	pakow. ☐ ☐	cena netto [zł]
<b>36-130-0010-000</b>	chrom	1 1	<b>20,81</b>
<b>36-130-0010-001</b>	biały	1 1	<b>20,81</b>
<b>36-130-0010-003</b>	czarny mat	1 1	<b>20,81</b>
<b>36-130-0010-006</b>	złoty	1 1	<b>20,81</b>
<b>36-130-0010-007</b>	różowe złoto	1 1	<b>20,81</b>



chrom



złoty



biały

różowe  
złoto

czarny mat

**PR03**Przycisk mosiężny  
kwadratowy, wypukły**(N)** GRUPA RABATOWA**NEXE**  
new line

indeks	kolor	pakow. ☐ ☐	cena netto [zł]
<b>36-130-0020-000</b>	chrom	1 1	<b>26,93</b>
<b>36-130-0020-001</b>	biały	1 1	<b>30,61</b>
<b>36-130-0020-003</b>	czarny mat	1 1	<b>30,61</b>
<b>36-130-0020-006</b>	złoty	1 1	<b>30,61</b>
<b>36-130-0020-007</b>	różowe złoto	1 1	<b>30,61</b>



chrom



złoty



biały

różowe  
złoto

czarny mat

**8B**Korek zamykający  
click-clack z przelewem,  
umywalkowy, okrągły,  
36 mm**(N)** GRUPA RABATOWA**NEXE**  
new line

indeks	kolor	pakow. ☐ ☐	cena netto [zł]
<b>36-104-0003-000</b>	chrom	1 50	<b>45,76</b>

**12**Korek zamykający  
click-clack z przelewem,  
umywalkowy, kwadratowy,  
68 mm**(N)** GRUPA RABATOWA**NEXE**  
new line

indeks	kolor	pakow. ☐ ☐	cena netto [zł]
<b>36-104-0000-000</b>	chrom	1 30	<b>80,12</b>

**NA-112PR+NA-1113X****IBIZA**  
komplet prysnicowy  
ze słuchawką 3-funkcyjną**(I)** GRUPA RABATOWA

indeks	pakow. ☐ ☐	cena netto [zł]
<b>35-200-0024-000</b>	1 10	<b>95,24</b>



**ZY-3046****LIMITA**komplet prysznicowy  
ze słuchawką 1-funkcyjną**I** GRUPA RABATOWA

indeks	pakow.  	cena netto [zł]
<b>35-200-0030-000</b>	1 1	<b>219,20</b>

**20**Komplet prysznicowy  
ze słuchawką 1-funkcyjną**N** GRUPA RABATOWA**NEXE**  
new line

indeks	pakow.  	cena netto [zł]
<b>36-105-0001-000</b>	1 1	<b>415,99</b>

Produkt dostępny  
do wyczerpania zapasów**JY-1302****MARCO**deszczownia ze słuchawką  
1-funkcyjną**I** GRUPA RABATOWA

indeks	pakow.  	cena netto [zł]
<b>35-200-0037-000</b>	1 1	<b>113,27</b>



20 x 20 cm

10  
x 10 cm**HY-1290****MASSIMO**deszczownia ze słuchawką  
1-funkcyjną**I** GRUPA RABATOWA

indeks	pakow.  	cena netto [zł]
<b>35-200-0038-000</b>	1 1	<b>100,81</b>



20 x 20 cm



10 x 10 cm

**TS-1337****MATTEO**deszczownia ze słuchawką  
1-funkcyjną**I** GRUPA RABATOWA

indeks	pakow.  	cena netto [zł]
<b>35-200-0032-000</b>	1 1	<b>77,66</b>



20 x 20 cm

10  
x 10 cm**JY-1504****MAURO**deszczownia ze słuchawką  
1-funkcyjną**I** GRUPA RABATOWA

indeks	pakow.  	cena netto [zł]
<b>35-200-0036-000</b>	1 1	<b>87,82</b>

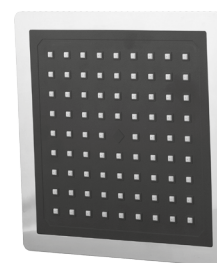

20 x 20 cm

9,5  
x 9,5 cm

**TS-1128**

**MAXIMO**  
deszczownia ze słuchawką  
1-funkcyjną



**I** GRUPA RABATOWA

indeks	pakow.	cena netto [zł]
<b>35-200-0031-000</b>	1 1	<b>68,73</b>

**HY-1310**

**CAMBIO/GOMERA**  
słuchawka prysznicowa  
1-funkcyjna



**I** GRUPA RABATOWA

indeks	pakow.	cena netto [zł]
<b>35-101-0014-000</b>	1 100	<b>14,98</b>

**HY-151B**

**PETRA**  
słuchawka prysznicowa  
1-funkcyjna



**N** GRUPA RABATOWA

**NEXE**  
new line

indeks	pakow.	cena netto [zł]
<b>36-101-0000-003</b>	1 100	<b>21,70</b>

**HY-026**

**RETINA**  
słuchawka prysznicowa  
1-funkcyjna



**N** GRUPA RABATOWA

**NEXE**  
new line

indeks	pakow.	cena netto [zł]
<b>36-101-0001-000</b>	1 100	<b>23,37</b>

**SH-1007**

**ALA**  
słuchawka prysznicowa  
1-funkcyjna



**I** GRUPA RABATOWA

indeks	pakow.	cena netto [zł]
<b>35-100-0001-000</b>	1 200	<b>13,81</b>

**NA-1151P**

**AZUR**  
słuchawka prysznicowa  
1-funkcyjna



**I** GRUPA RABATOWA

indeks	pakow.	cena netto [zł]
<b>35-101-0007-000</b>	1 40	<b>21,04</b>



**TS-1787****ANDREA**

słuchawka zlewozmywakowa  
2-funkcyjna do baterii  
z wymiową wylewką



**I** GRUPA RABATOWA

indeks	pakow. ☐ ☐	cena netto [zł]
<b>35-102-0002-000</b>	1 40	<b>40,57</b>

**SH-2005****KINGA**

słuchawka zlewozmywakowa  
2-funkcyjna do baterii  
z wymiową wylewką



**I** GRUPA RABATOWA

indeks	pakow. ☐ ☐	cena netto [zł]
<b>35-100-0006-000</b>	1 40	<b>40,57</b>

**HY-1406****GERTA**

słuchawka prysznicowa  
3-funkcyjna



**N** GRUPA RABATOWA

**NEXE**  
new line

indeks	pakow. ☐ ☐	cena netto [zł]
<b>36-103-0002-000</b>	1 20	<b>30,09</b>



funkcja  
STOP

**HY-001B****MORENA**

słuchawka prysznicowa  
3-funkcyjna



**N** GRUPA RABATOWA

**NEXE**  
new line

indeks	pakow. ☐ ☐	cena netto [zł]
<b>36-103-0000-103</b>	1 20	<b>52,09</b>



Wciśnij przycisk,  
aby zmienić funkcję  
strumienia wody!

**HY-018C****NOEMI**

słuchawka prysznicowa  
3-funkcyjna



**N** GRUPA RABATOWA

**NEXE**  
new line

indeks	pakow. ☐ ☐	cena netto [zł]
<b>36-103-0005-000</b>	1 20	<b>37,04</b>

**HY-002B****TREVIA**

słuchawka prysznicowa  
3-funkcyjna



**N** GRUPA RABATOWA

**NEXE**  
new line

indeks	pakow. ☐ ☐	cena netto [zł]
<b>36-103-0001-103</b>	1 20	<b>52,09</b>



Wciśnij przycisk,  
aby zmienić funkcję  
strumienia wody!

**HY-006****WEDERA**słuchawka prysznicowa  
3-funkcyjna**(N)** GRUPA RABATOWA**NEXE**  
new line

indeks	pakow.	cena netto [zł]
<b>36-103-0004-000</b>	1 20	<b>30,09</b>

Czyszczenie  
mechaniczne**NA-1235****GAZELA**słuchawka prysznicowa  
3-funkcyjna**(I)** GRUPA RABATOWA

indeks	pakow.	cena netto [zł]
<b>35-103-0009-000</b>	1 50	<b>24,39</b>

**NA-1115B****BORNEO**słuchawka prysznicowa  
3-funkcyjna**(I)** GRUPA RABATOWA

indeks	pakow.	cena netto [zł]
<b>35-103-0005-000</b>	1 25	<b>39,38</b>

**NA-1113X****ITAKA**słuchawka prysznicowa  
3-funkcyjna**(I)** GRUPA RABATOWA

indeks	pakow.	cena netto [zł]
<b>35-103-0003-000</b>	1 50	<b>22,63</b>

**NA-1113****FIDZI**słuchawka prysznicowa  
3-funkcyjna**(I)** GRUPA RABATOWA

indeks	pakow.	cena netto [zł]
<b>35-103-0010-000</b>	1 40	<b>23,45</b>

**NA-1113S****TRIO**słuchawka prysznicowa  
3-funkcyjna**(I)** GRUPA RABATOWA

indeks	pakow.	cena netto [zł]
<b>35-103-0004-000</b>	1 50	<b>29,86</b>



**HY-053**

**MARINI**  
słuchawka prysznicowa  
5-funkcyjna



**(N)** GRUPA RABATOWA

**NEXE**  
new line

indeks	pakow. ☐ ☐	cena netto [zł]
<b>36-105-0003-000</b>	1 50	<b>33,39</b>



**NA-1223**

**BRAVA**  
słuchawka prysznicowa  
5-funkcyjna



**(I)** GRUPA RABATOWA

indeks	pakow. ☐ ☐	cena netto [zł]
<b>35-105-0003-000</b>	1 20	<b>39,25</b>



**TS-1124**

**SIMONA**  
słuchawka prysznicowa  
5-funkcyjna



**(I)** GRUPA RABATOWA

indeks	pakow. ☐ ☐	cena netto [zł]
<b>35-105-0008-000</b>	1 30	<b>43,74</b>



**BD-9009**

**LANGUSTA**  
drążek prysznicowy  
z przysawką

**(I)** GRUPA RABATOWA

indeks	pakow. ☐ ☐	cena netto [zł]
<b>35-200-0043-000</b>	1 10	<b>123,49</b>

Produkt dostępny  
do wyczerpania zapasów



ok.  $\varnothing$ 22,5 mm  
Możliwość regulacji



**TS-4017**

**REMO**  
drążek prysznicowy z mydelniczką  
dł. 60cm

**(I)** GRUPA RABATOWA

indeks	pakow. ☐ ☐	cena netto [zł]
<b>35-200-0040-000</b>	1 20	<b>101,88</b>



**TS-4023**

**ROBERTO**  
drążek prysznicowy  
dł. 64cm

**(I)** GRUPA RABATOWA

indeks	pakow. ☐ ☐	cena netto [zł]
<b>35-200-0039-000</b>	1 20	<b>87,98</b>



**NA-1112PD****ZANZIBAR**

drążek prysznicowy z mydelniczką

I GRUPA RABATOWA

indeks	pakow.	cena netto [zł]
<b>35-200-0015-000</b>	1 10	<b>93,15</b>

**NA123WD****PASJA**

Drążek wygięty z półką

I GRUPA RABATOWA

**NEXE**  
new line

indeks	pakow.	cena netto [zł]
<b>35-200-0016-000</b>	1 20	<b>91,60</b>

**R10N**

Ramię prysznicowe dla zestawów podtynkowych z deszczownią

N GRUPA RABATOWA

**NEXE**  
new line

indeks	pakow.	cena netto [zł]
<b>36-107-0000-000</b>	1 1	<b>264,82</b>

Produkt dostępny do wyczerpania zapasów

**BR9015****KORAL**

uchwyt punktowy prysznicowy

I GRUPA RABATOWA

indeks	pakow.	cena netto [zł]
<b>35-200-0044-000</b>	1 500	<b>7,43</b>

**BR-9005M****KRAB**

uchwyt punktowy prysznicowy

I GRUPA RABATOWA

indeks	pakow.	cena netto [zł]
<b>35-200-0018-000</b>	1 100	<b>24,77</b>

**BR-9009****LANGUSTA**

uchwyt punktowy prysznicowy z przysawką

I GRUPA RABATOWA

indeks	pakow.	cena netto [zł]
<b>35-200-0028-000</b>	1 100	<b>36,69</b>

Produkt dostępny do wyczerpania zapasów





**BR9008****RAK**  
uchwyt punktowy prysznicowy**I** GRUPA RABATOWA

indeks	pakow. ☐ ☐	cena netto [zł]
<b>35-200-0019-000</b>	1 200	<b>7,73</b>

**HS-019**Wąż prysznicowy wzmocniony  
½" x ½"**I** GRUPA RABATOWA

indeks	wąż [cm]	pakow. ☐ ☐	cena netto [zł]
<b>35-400-1200-000</b>	120	1 60	<b>23,44</b>
<b>35-400-1500-000</b>	150	1 60	<b>25,42</b>
<b>35-400-1750-000</b>	175	1 60	<b>28,37</b>
<b>35-400-2000-000</b>	200	1 60	<b>32,23</b>

**P9**

Uchwyt punktowy

**N** GRUPA RABATOWA**NEXE**  
new line

indeks	pakow. ☐ ☐	cena netto [zł]
<b>36-103-0000-000</b>	1 100	<b>31,00</b>

**HS-020**Wąż prysznicowy elastyczny -  
rozciągliwy ½"x½"**I** GRUPA RABATOWA

indeks	wąż [cm]	pakow. ☐ ☐	cena netto [zł]
<b>35-401-1200-000</b>	120-150	1 50	<b>38,65</b>
<b>35-401-1500-000</b>	150-180	1 30	<b>45,23</b>
<b>35-401-1750-000</b>	175-210	1 50	<b>46,12</b>

**R10**Uchwyt punktowy z ruchomą  
końcówką**N** GRUPA RABATOWA**NEXE**  
new line

indeks	pakow. ☐ ☐	cena netto [zł]
<b>36-103-0000-003</b>	1 100	<b>26,55</b>

**P4CM**

Wąż prysznicowy

**N** GRUPA RABATOWA**NEXE**  
new line

indeks	wąż [cm]	pakow. ☐ ☐	cena netto [zł]
<b>36-117-0150-003</b>	150	1 50	<b>44,60</b>



**P4S**

Wąż prysznicowy

**(N)** GRUPA RABATOWA**NEXE**  
new line

indeks	wąż [cm]	pakow. 	cena netto [zł]
<b>36-115-0150-008</b>	150	1 50	<b>44,60</b>

**P19CM**

Wąż prysznicowy

**(N)** GRUPA RABATOWA**NEXE**  
new line

indeks	wąż [cm]	pakow. 	cena netto [zł]
<b>36-116-0150-003</b>	150	1 50	<b>35,00</b>

**HS-018**Wąż do baterii z wyjmowaną  
wylewką, M15x1 x 1/2"**(I)** GRUPA RABATOWA

indeks	wąż [cm]	pakow. 	cena netto [zł]
<b>35-402-1200-100</b>	120	1 50	<b>22,59</b>

**NA-12H**Wąż prysznicowy 1/2" x 1/2"  
„Bamboo”**(I)** GRUPA RABATOWA

indeks	wąż [cm]	pakow. 	cena netto [zł]
<b>35-402-1500-000</b>	150	1 60	<b>23,56</b>

Produkt dostępny  
do wyczerpania zapasów**BT-9009****LANGUSTA**  
zawieszanie do ręcznika  
z przyssawką**(I)** GRUPA RABATOWA

indeks	pakow. 	cena netto [zł]
<b>35-308-0000-300</b>	1 10	<b>90,95</b>

Produkt dostępny  
do wyczerpania zapasów**BS-9009****LANGUSTA**  
mydelniczka z przyssawką**(I)** GRUPA RABATOWA

indeks	pakow. 	cena netto [zł]
<b>35-310-0000-000</b>	1 50	<b>57,89</b>

Produkt dostępny  
do wyczerpania zapasów

**BPK-9009****LANGUSTA**zawieszenie do papieru  
toaletowego z przyssawką GRUPA RABATOWA

indeks	pakow.  	cena netto <sup>[zł]</sup>
<b>35-308-0000-100</b>	1 20	<b>66,14</b>

Produkt dostępny  
do wyczerpania zapasów**BPS-9009****LANGUSTA**zawieszenie do papieru  
toaletowego z przyssawką GRUPA RABATOWA

indeks	pakow.  	cena netto <sup>[zł]</sup>
<b>35-308-0000-200</b>	1 50	<b>52,57</b>

Produkt dostępny  
do wyczerpania zapasów**BPR-9009****LANGUSTA**zawieszenie do ręcznika  
z przyssawką GRUPA RABATOWA

indeks	pakow.  	cena netto <sup>[zł]</sup>
<b>35-308-0000-000</b>	1 20	<b>66,14</b>

Produkt dostępny  
do wyczerpania zapasów**BB-9009****LANGUSTA**

szczotka do WC z przyssawką

 GRUPA RABATOWA

indeks	pakow.  	cena netto <sup>[zł]</sup>
<b>35-309-0000-000</b>	1 10	<b>99,21</b>

Produkt dostępny  
do wyczerpania zapasów**BS-9009/1****LANGUSTA**adapter do akcesoriów  
z przyssawką do nierównych  
powierzchni GRUPA RABATOWA

indeks	pakow.  	cena netto <sup>[zł]</sup>
<b>35-311-0000-000</b>	1 400	<b>10,04</b>

Produkt dostępny  
do wyczerpania zapasów**BD-9009/1****LANGUSTA**adapter do drążka BD-9009  
do nierównych powierzchni GRUPA RABATOWA

indeks	pakow.  	cena netto <sup>[zł]</sup>
<b>35-311-0000-100</b>	1 200	<b>10,04</b>

Produkt dostępny  
do wyczerpania zapasów



## AKCESORIA/ CZĘŚCI DO BATERII 124-127

<b>Perlatory</b>	125
<b>Przedłużki i pokrętła</b>	126
<b>Głowice do baterii</b>	126
<b>Wylewki do baterii</b>	127
<b>Inne akcesoria</b>	127

**P1****NEXE ECO**  
perlator do baterii**NEXE**  
new line

indeks	wielkość	pakowanie		cena netto [zł]
<b>36-114-0001-000</b>	M24 x GZ1"	1	250	<b>16,00</b>

GRUPA RABATOWA

**P2****NEXE ECO**  
perlator do baterii**NEXE**  
new line

indeks	wielkość	pakowanie		cena netto [zł]
<b>36-114-0000-000</b>	M22 x GW1"	1	250	<b>16,00</b>

GRUPA RABATOWA

**08**

Perlator do baterii



indeks	wielkość	pakowanie		cena netto [zł]
<b>35-301-0000-000</b>	M22 x GW1"	25	2000	<b>4,41</b>

GRUPA RABATOWA

**09**

Perlator do baterii



indeks	wielkość	pakowanie		cena netto [zł]
<b>35-301-0006-000</b>	M24 x GZ1"	100	1000	<b>4,41</b>

GRUPA RABATOWA

**10**

Perlator do baterii



indeks	wielkość	pakowanie		cena netto [zł]
<b>35-301-0001-000</b>	M28 x GZ1"	10	1000	<b>8,82</b>

GRUPA RABATOWA

**NA-PR1P****TUKAN**  
perlator długi z redukcją  
2-funkcyjny długi wąż tworzywowy

indeks	pakowanie		cena netto [zł]
<b>35-301-0003-000</b>	1	100	<b>15,85</b>

GRUPA RABATOWA

**NA-PR2****PELIKAN**  
perlator długi z redukcją  
2-funkcyjny długi wąż chromowany

indeks	pakowanie		cena netto [zł]
<b>35-301-0004-000</b>	1	100	<b>19,97</b>

GRUPA RABATOWA

**NA-PR3P****ARA**  
perlator z redukcją 2-funkcyjny  
na przegubie krótkim

indeks	pakowanie		cena netto [zł]
<b>35-301-0005-000</b>	1	100	<b>15,85</b>

GRUPA RABATOWA

**BR9045****KOLIBER**

Perlator krótki z redukcją  
2-funkcyjny



indeks	pakowanie	cena netto [zł]
<b>35-301-0002-000</b>	1 100	<b>10,59</b>

I GRUPA RABATOWA

**PHA-351**

Przedłużka pod baterię  
naścienną mosiężna  
chromowana WZ

**PERFEKT<sup>2</sup>SYSTEM**

indeks	wielkość	PN	Tmax	pakowanie	cena netto [zł]
<b>07-351-0200-000</b>	¾"	16	+180°C	20 180	<b>17,71</b>

D GRUPA RABATOWA

**H511**

Pokrętło baterii  
2-uchwytowych PRIMULA



indeks	wielkość	kolor	pakowanie	cena netto [zł]
<b>35-300-0000-000</b>	½" x ¾"	niebieski lub czerwony	50 400	<b>7,10</b>

I GRUPA RABATOWA

**POLONIA**

**POLONIA**  
głowica do baterii  
2-uchwytowych



indeks	wielkość	typ	pakowanie	cena netto [zł]
<b>35-302-0000-010</b>	¾"	dziewczynka	50 400	<b>7,07</b>
<b>35-302-0000-000</b>	½"	dziewczynka	30 240	<b>9,47</b>
<b>35-302-0000-100</b>	½"	chłopiec	30 240	<b>9,47</b>

I GRUPA RABATOWA

**10C/10N**

Głowica ceramiczna prawa  
do baterii 2-uchwytowych



indeks	typ	kolor	pakowanie	cena netto [zł]
<b>35-302-0001-000</b>	prawa	czerwona	1 400	<b>14,03</b>
<b>35-302-0001-100</b>	prawa	niebieska	1 400	<b>14,03</b>

I GRUPA RABATOWA

**C201/C202**

Głowica ceramiczna  
do baterii 1-uchwytowych



indeks	wielkość	typ	symbol	pakowanie	cena netto [zł]
<b>35-302-0002-350</b>	35	niska	C201	1 100	<b>16,55</b>
<b>35-302-0003-350</b>	35	wysoka	C202	1 100	<b>16,55</b>
<b>35-302-0002-400</b>	40	niska	C201	1 100	<b>16,90</b>
<b>35-302-0003-400</b>	40	wysoka	C202	1 100	<b>16,90</b>

I GRUPA RABATOWA

**07**

Mimośród do baterii



indeks	wielkość	pakowanie	cena netto [zł]
<b>35-303-0000-000</b>	½" x ¾"	2 320	<b>13,32</b>

I GRUPA RABATOWA

**WL1**

Wylewka płaska do baterii,  
wygięta, nakrętki 3/4"



I GRUPA RABATOWA

indeks	wielkość	typ	nakrętki	pakowanie		cena netto [zł]
<b>35-304-0000-300</b>	14 cm	wygięta	3/4"	1	100	<b>33,16</b>
<b>35-304-0000-100</b>	16 cm	wygięta	3/4"	1	100	<b>35,07</b>
<b>35-304-0000-200</b>	22 cm	wygięta	3/4"	1	100	<b>44,66</b>

**WL2C**

Wylewka rurkowa  
do baterii



I GRUPA RABATOWA

indeks	wielkość	typ	nakrętki	pakowanie		cena netto [zł]
<b>35-304-0000-400</b>	16 cm	C	1/2"	1	50	<b>27,13</b>
<b>35-304-0000-500</b>	25 cm	C	1/2"	1	50	<b>30,29</b>

**WL2S**

Wylewka rurkowa  
do baterii



I GRUPA RABATOWA

indeks	wielkość	typ	nakrętki	pakowanie		cena netto [zł]
<b>35-304-0000-600</b>	16 cm	S	1/2"	1	50	<b>27,13</b>
<b>35-304-0000-700</b>	25 cm	S	1/2"	1	50	<b>30,29</b>

**DIV-1**

Przełącznik mechaniczny  
do baterii wannowej



I GRUPA RABATOWA

indeks	pakowanie		cena netto [zł]
<b>35-306-0000-000</b>	50	400	<b>14,67</b>

UNIWERSALNE ZASTOSOWANIE, NIEZALEŻNIE OD CIŚNIENIA W INSTALACJI

**PAD-1**

Stabilizator do mocowania  
baterii stojących



I GRUPA RABATOWA

indeks	pakowanie		cena netto [zł]
<b>35-307-0000-000</b>	1	500	<b>5,26</b>

**A.695/09004W**

Zaślepka



E GRUPA RABATOWA

indeks	pakowanie		cena netto [zł]
<b>98-035-0001-000</b>	100	1000	<b>13,70</b>

**A.695/09004C**

Zaślepka



E GRUPA RABATOWA

indeks	pakowanie		cena netto [zł]
<b>98-035-0002-000</b>	100	1000	<b>14,20</b>



Możliwość rozciągnięcia  
i kształtowania



# ARMATURA SANITARNA 128-129

Przyłącza

129

Węże do pralki

129



## 969

Przyłącze elastyczne ABS



indeks	wielkość	pakowanie		cena netto [zł]
<b>40-969-3232-000</b>	1¼ x 32	1	100	<b>8,13</b>
<b>40-969-4050-000</b>	1½ x 40/50	1	100	<b>9,78</b>

**E** GRUPA RABATOWA

## 991

Przyłącze rozciągliwe WC



indeks	pakowanie		cena netto [zł]
<b>40-991-0000-000</b>	1	30	<b>29,79</b>

**E** GRUPA RABATOWA

## 997

Łącznik mimośrodowy WC



indeks	pakowanie		cena netto [zł]
<b>40-997-0000-000</b>	1	60	<b>9,83</b>

**E** GRUPA RABATOWA

Produkt dostępny do wyczerpania zapasów

## 998

Łącznik prosty WC



indeks	pakowanie		cena netto [zł]
<b>40-998-0000-000</b>	1	60	<b>9,83</b>

**E** GRUPA RABATOWA

Produkt dostępny do wyczerpania zapasów

## 96C/96W

Syfon do pralki natynkowy



indeks	kolor	pakowanie		cena netto [zł]
<b>40-961-0000-000</b>	chrom	1	100	<b>15,98</b>
<b>40-960-0000-000</b>	biały	1	100	<b>11,48</b>

**E** GRUPA RABATOWA

## 291

Wąż zasilający do pralki ¾" x ¾"



indeks	wielkość	pakowanie		cena netto [zł]
<b>35-403-1500-000</b>	150	1	10	<b>19,20</b>
<b>35-403-2000-000</b>	200	1	10	<b>19,39</b>
<b>35-403-2500-000</b>	250	1	10	<b>22,71</b>
<b>35-403-3000-000</b>	300	1	10	<b>25,19</b>

**C** GRUPA RABATOWA

## 306

Wąż odprowadzający do pralki



indeks	wielkość	pakowanie		cena netto [zł]
<b>35-404-1500-000</b>	150	1	1	<b>12,08</b>
<b>35-405-2000-000</b>	200	1	1	<b>13,90</b>
<b>35-405-2500-000</b>	250	1	1	<b>19,13</b>
<b>35-404-3000-000</b>	300	1	1	<b>16,32</b>

**C** GRUPA RABATOWA

# NOTATKI

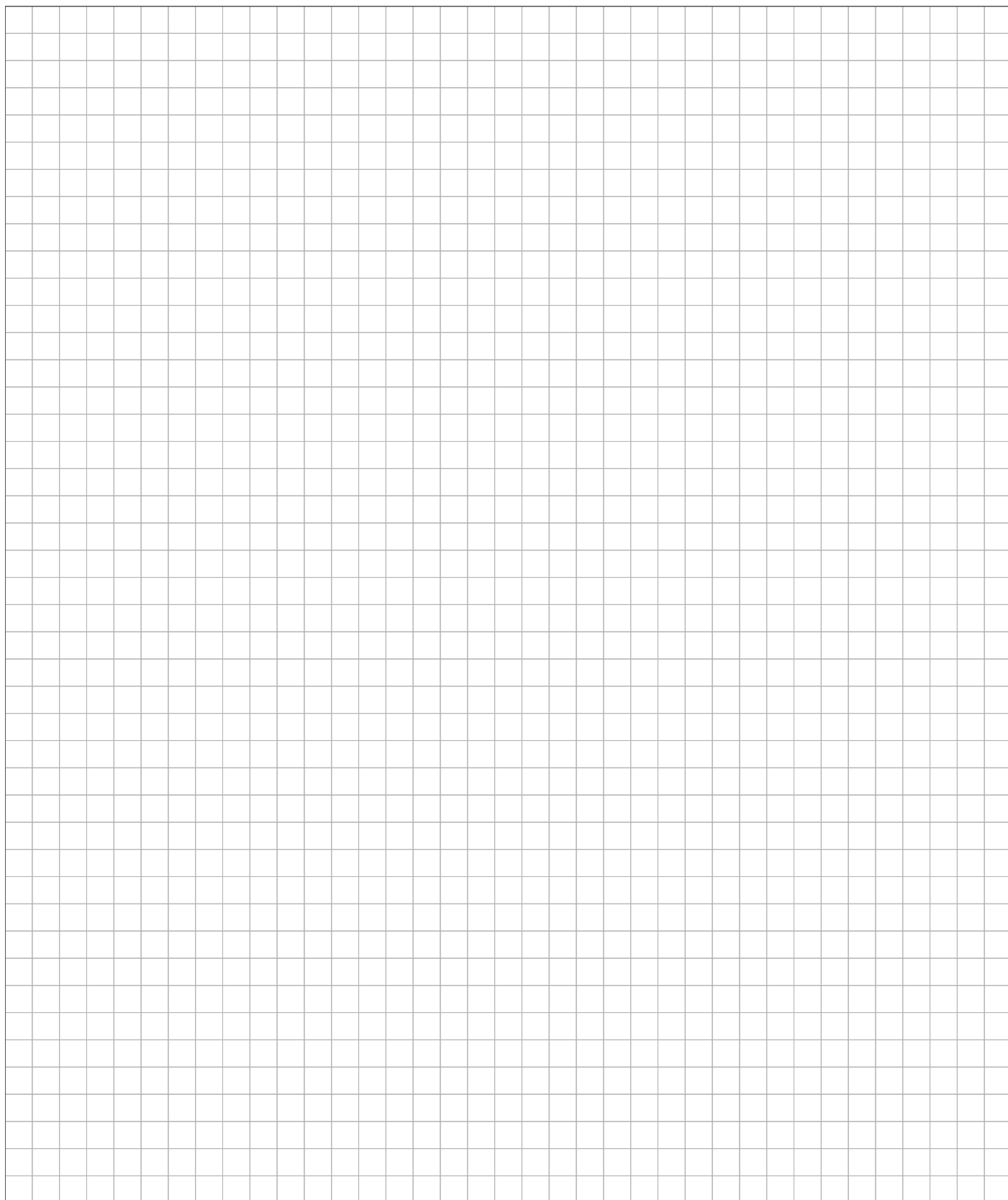

**PERFEXIM**

Perfexim spółka z ograniczoną odpowiedzialnością  
ul. Samotna 2, 61-441 Poznań, POLSKA

[www.perfexim.pl](http://www.perfexim.pl)

## WARUNKI RABATÓW

grupa	
A	
B	
C	
D	
E	
G	
H	
HS	
I	
J	
K	
K1	
K2	
K3	
L	
N	
P	
Z	



### **ZŁOTY LAUR KONSUMENTA**

w kategorii Producent i importer  
branży instalacyjno-grzewczej, łazienkowej i sanitarnej

### **LAUR KONSUMENTA - ODKRYCIE ROKU**

w kategorii Polska jakość branży budowlanej.  
Jakość produktów, usług i obecność w świadomości  
konsumentów

Niniejszy cennik nie stanowi oferty w rozumieniu przepisów Kodeksu Cywilnego i jest tylko informacją wstępną. Do zawarcia indywidualnej umowy może dojść wyłącznie po uzgodnieniu istotnych jej postanowień. Równocześnie Producent zastrzega sobie prawo do wprowadzenia zmian i modyfikacji cen oraz danych technicznych produktów wymienionych w niniejszym Cenniku, a także zmian wynikających z mogących wystąpić błędów lub pomyłek.

Zdjęcia produktów mają charakter poglądowy.  
Do podanych cen netto należy doliczyć podatek VAT w wysokości 23%.

Perfexim spółka z ograniczoną odpowiedzialnością  
ul. Samotna 2, 61-441 Poznań, Polska