

PERFEXIM

PERFEKT[?] SYSTEM

NEXE
new line

CENNIK 2024



www.perfexim.pl
Cennik ważny od 15.03.2024

PERFEXIM

LEGENDA



jakość marki
PERFEXIM SYSTEM



centralne
ogrzewanie



lat gwarancji



chłodnictwo



aprobata
techniczna



glikol



wytrzymałość



powietrze



mosiądz



woda ciepła
i zimna



atest
higieniczny



znak
budowlany



**ZŁOTY LAUR
KONSUMENTA**
w kategorii Producent
i importer branży instalacyjno-
grzewczej, łazienkowej i sanitarnej

**LAUR
KONSUMENTA
- ODKRYCIE ROKU**
w kategorii Polska jakość
branży budowlanej. Jakość produktów,
usług i obecność w świadomości
konsumentów

SPIIS TREŚCI

ARMATURA WODNA

5-30

Kurki kulowe	5
Filtry do wody	11
Zawory zwrotne	12
Zasuwy	13
Zawory antyskażeniowe	13
Zawory przepływowe	13
Zawory zwrotne kulowe różnicowe	14
Zawory żeliwne	14
Kurki i zawory czerpalne	14
Złączki mosiężne wzmocnione	16
Śrubunki mosiężne wzmocnione	19
Złączki mosiężne	20
Śrubunki mosiężne	22
Śrubunki wodomierza	23
Konsole wodomierza	23
Złączki mosiężne chromowane	24
Śrubunki mosiężne chromowane	25
Taśmy teflonowe	26
Kurki i zawory podłączeniowe	26
Przyłącza elastyczne	28

ARMATURA GAZOWA

32

Kurki kulowe	33
Filtry	33
Przyłącza	33

ARMATURA CENTRALNEGO OGRZEWANIA

34-54

System antyzamrozeniowy	35
Komplety / głowice termostatyczne	35
Zawory grzejnikowe	39
Zawory bezpieczeństwa	42
Pompy obiegowe	43
Rozdzielacze, osprzęt rozdzielaczy	44
Zawory odpowietrzające	53
Automatyka ogrzewania	54
Uchwyty do bojlerów	54

SYSTEMY RUROWE WIELOWARSTWOWE

55-67

Rury PERT	56
Rury PEX	56
Złączki zaprasowywane	57
Złączki skręcane	63
System montażowy	66
Narzędzia	67

RURA MIEDZIANA

72-74

Rury twarde i miękkie	73
-----------------------	----

GRZEJNIKI PŁYTKOWE I ALUMINIOWE

75-80

Grzejniki płytowe C i V	76
Grzejniki aluminiowe	78
Osprzęt grzejników aluminiowych	78
Głowice termostatyczne	78
Osprzęt grzejników stalowych	80

BATERIE PODTYNKOWE

81-88

Baterie podtynkowe	82
Akcesoria do baterii podtynkowych	86

ARMATURA KUCHENNA I ŁAZIENKOWA

89-123

Baterie WEGA	90
Baterie RENO	92
Baterie kuchenne i łazienkowe	94
głowica 40	94
głowica 35	98
Baterie ciśnieniowe	108
Syfony	108
Korki zamykające	109
Komplety prysznicowe	114
Słuchawki z deszczownicą	115
Słuchawki	116
Drażki prysznicowe	119
Uchwyty punktowe	120
Wężę prysznicowe	121
Akcesoria łazienkowe z przyssawką	122

AKCESORIA / CZĘŚCI DO BATERII

124-127

Perlatory	125
Przedłużki i pokrętła	126
Głowice do baterii	126
Wylewki do baterii	127
Inne akcesoria	127

ARMATURA SANITARNA

128-129

Przyłącza	129
Wężę do pralki	129



Pewna, kompletna
i różnorodna armatura wodna

PERFEXIM

CENNIK ARMATURA 2024



PERFEKT[?]SYSTEM

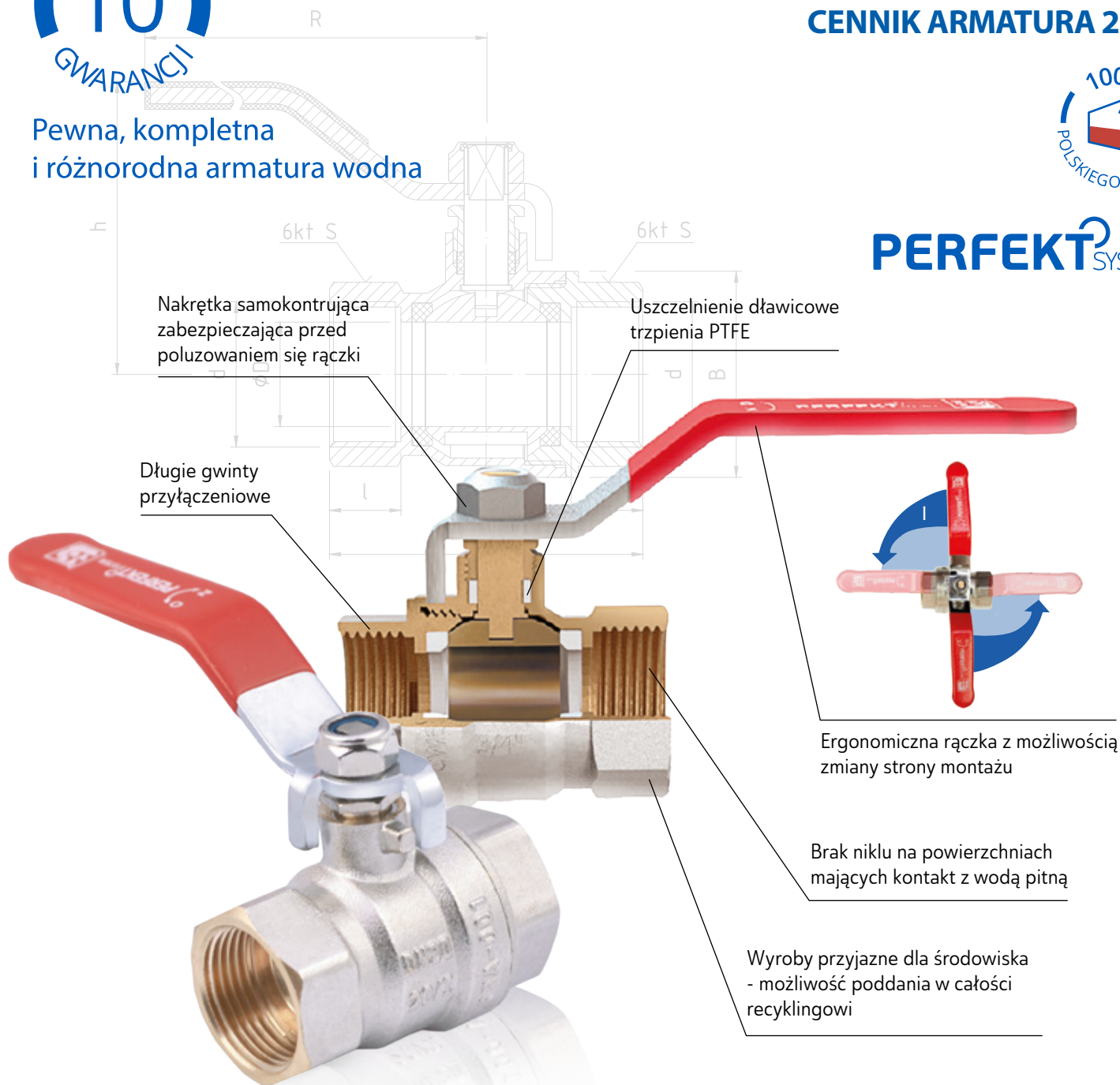

Nakrętka samokontrująca
zabezpieczająca przed
poluzowaniem się rączki

Uszczelnienie dławicowe
trzczenia PTFE

Długie gwinty
przyłączeniowe

Ergonomiczna rączka z możliwością
zmiany strony montażu

Brak niklu na powierzchniach
mających kontakt z wodą pitną

Wyroby przyjazne dla środowiska
- możliwość poddania w całości
recyklingowi

ARMATURA WODNA

5-30

Kurki kulowe	5
Filtry do wody	11
Zawory zwrotne	12
Zasuwy	13
Zawory antyskażeniowe	13
Zawory przepływowe	13
Zawory zwrotne kulowe różnicowe	14
Zawory żeliwne	14
Kurki i zawory czerpalne	14
Złączki mosiężne wzmocnione	16
Śrubunki mosiężne wzmocnione	19
Złączki mosiężne	20
Śrubunki mosiężne	22
Śrubunki wodomierza	23
Konsole wodomierza	23
Złączki mosiężne chromowane	24
Śrubunki mosiężne chromowane	25
Taśmy teflonowe	26
Kurki i zawory podłączeniowe	26
Przyłącza elastyczne	28

PHA-001

PERFEKT SYSTEM
Kurek kulowy WW

(K) GRUPA RABATOWA

PERFEKT² SYSTEM

indeks	wielkość	PN	rodzaj uchwytu	kolor uchwytu	Tmax	pakowanie		cena netto [zł]
00-001-0100-000	3/8"	30	rączka	czerwony	+150°C	10	200	17,67
00-001-0150-000	1/2"	30	rączka	czerwony	+150°C	15	150	23,83
00-001-0200-000	3/4"	30	rączka	czerwony	+150°C	10	100	34,73
00-001-0250-000	1"	30	rączka	czerwony	+150°C	6	60	56,17
00-001-0320-000	1 1/4"	30	rączka	czerwony	+150°C	4	40	88,96
00-001-0400-000	1 1/2"	30	rączka	czerwony	+150°C	4	32	134,15
00-001-0500-000	2"	30	rączka	czerwony	+150°C	2	20	202,13
00-001-0650-000	2 1/2"	30	rączka	czerwony	+150°C	2	10	426,63
00-001-0800-000	3"	30	rączka	czerwony	+150°C	2	4	586,05
00-001-1000-000	4"	30	rączka	czerwony	+150°C	2	4	1032,88

PHA-001

PERFEKT SYSTEM
Kurek kulowy WW

(K) GRUPA RABATOWA

PERFEKT² SYSTEM

indeks	wielkość	PN	rodzaj uchwytu	kolor uchwytu	Tmax	pakowanie		cena netto [zł]
00-001-0100-001	3/8"	30	rączka	niebieski	+150°C	10	200	17,67
00-001-0150-001	1/2"	30	rączka	niebieski	+150°C	15	150	23,83
00-001-0200-001	3/4"	30	rączka	niebieski	+150°C	10	100	34,73
00-001-0250-001	1"	30	rączka	niebieski	+150°C	6	60	56,17
00-001-0320-001	1 1/4"	30	rączka	niebieski	+150°C	4	40	88,96
00-001-0400-001	1 1/2"	30	rączka	niebieski	+150°C	4	32	134,15
00-001-0500-001	2"	30	rączka	niebieski	+150°C	2	20	202,13
00-001-0650-001	2 1/2"	30	rączka	niebieski	+150°C	2	10	426,63
00-001-0800-001	3"	30	rączka	niebieski	+150°C	2	4	586,05
00-001-1000-001	4"	30	rączka	niebieski	+150°C	2	4	1032,88

PHA-002

PERFEKT SYSTEM
Kurek kulowy WW

(K) GRUPA RABATOWA

dostępny w III kwartale 2024

PERFEKT² SYSTEM

indeks	wielkość	PN	rodzaj uchwytu	kolor uchwytu	Tmax	pakowanie		cena netto [zł]
00-002-0150-000	1/2"	30	motyl	czerwony	+150°C	15	150	24,70
00-002-0200-000	3/4"	30	motyl	czerwony	+150°C	10	100	33,95
00-002-0250-000	1"	30	motyl	czerwony	+150°C	6	60	55,47
00-002-0320-000	1 1/4"	30	motyl	czerwony	+150°C			87,20

PHA-002

PERFEKT SYSTEM
Kurek kulowy WW

(K) GRUPA RABATOWA

PERFEKT² SYSTEM

indeks	wielkość	PN	rodzaj uchwytu	kolor uchwytu	Tmax	pakowanie		cena netto [zł]
00-002-0150-001	1/2"	30	motyl	niebieski	+150°C	15	150	24,70
00-002-0200-001	3/4"	30	motyl	niebieski	+150°C	10	100	33,95
00-002-0250-001	1"	30	motyl	niebieski	+150°C	6	60	55,47

PHA-002C

PERFEKT SYSTEM
Kurek kulowy z podejściem do czujnika M10x1

(K) GRUPA RABATOWA

PERFEKT² SYSTEM

indeks	wielkość	PN	rodzaj uchwytu	kolor uchwytu	Tmax	pakowanie		cena netto [zł]
00-002-0150-003	1/2"	30	motyl	czerwony	+150°C	10	200	32,82
00-002-0200-003	3/4"	30	motyl	czerwony	+150°C	15	150	45,62

PHA-003

PERFEKT SYSTEM
Kurek kulowy WZ

(K) GRUPA RABATOWA

dostępny w III kwartale 2024

PERFEKT² SYSTEM

indeks	wielkość	PN	rodzaj uchwytu	kolor uchwytu	Tmax	pakowanie		cena netto [zł]
00-003-0150-000	1/2"	30	rączka	czerwony	+150°C	15	150	26,05
00-003-0200-000	3/4"	30	rączka	czerwony	+150°C	10	100	37,88
00-003-0250-000	1"	30	rączka	czerwony	+150°C	6	60	63,54
00-003-0320-000	1 1/4"	30	rączka	czerwony	+150°C			96,10

PHA-003

PERFEKT SYSTEM
Kurek kulowy WZ

(K) GRUPA RABATOWA

PERFEKT² SYSTEM

indeks	wielkość	PN	rodzaj uchwyty	kolor uchwyty	Tmax	pakowanie		cena netto [zł]
00-003-0150-001	½"	30	rączka	niebieski	+150°C	15	150	26,05
00-003-0200-001	¾"	30	rączka	niebieski	+150°C	10	100	37,88
00-003-0250-001	1"	30	rączka	niebieski	+150°C	6	60	63,54

PHA-004

PERFEKT SYSTEM
Kurek kulowy WZ

dostępny w III kwartale 2024

(K) GRUPA RABATOWA

PERFEKT² SYSTEM

indeks	wielkość	PN	rodzaj uchwyty	kolor uchwyty	Tmax	pakowanie		cena netto [zł]
00-004-0150-000	½"	30	motyl	czerwony	+150°C	15	150	25,32
00-004-0200-000	¾"	30	motyl	czerwony	+150°C	10	100	35,93
00-004-0250-000	1"	30	motyl	czerwony	+150°C	6	60	59,05
00-004-0320-000	1¼"	30	motyl	czerwony	+150°C			88,40

PHA-004

PERFEKT SYSTEM
Kurek kulowy WZ

(K) GRUPA RABATOWA

PERFEKT² SYSTEM

indeks	wielkość	PN	rodzaj uchwyty	kolor uchwyty	Tmax	pakowanie		cena netto [zł]
00-004-0150-001	½"	30	motyl	niebieski	+150°C	15	150	25,32
00-004-0200-001	¾"	30	motyl	niebieski	+150°C	10	100	35,93
00-004-0250-001	1"	30	motyl	niebieski	+150°C	6	60	59,05

PHA-005

PERFEKT SYSTEM
Kurek kulowy ze śrubunkiem

(K) GRUPA RABATOWA

PERFEKT² SYSTEM

indeks	wielkość	PN	rodzaj uchwyty	kolor uchwyty	Tmax	pakowanie		cena netto [zł]
00-005-0150-000	½"	30	motyl	czerwony	+150°C	10	120	28,99
00-005-0200-000	¾"	30	motyl	czerwony	+150°C	10	100	45,40
00-005-0250-000	1"	30	motyl	czerwony	+150°C	6	60	77,62
00-005-0320-000	1¼"	30	motyl	czerwony	+150°C	4	24	113,14

PHA-005/SM

PERFEKT SYSTEM
Kurek kulowy ze śrubunkiem

(K) GRUPA RABATOWA

Produkt dostępny do wyczerpania zapasów

PERFEKT² SYSTEM

indeks	wielkość	PN	rodzaj uchwyty	kolor uchwyty	Tmax	pakowanie		cena netto [zł]
00-005-0150-200	½"	30	motyl	czerwony	+150°C	10	120	28,99
00-005-0200-200	¾"	30	motyl	czerwony	+150°C	10	100	45,40
00-005-0250-200	1"	30	motyl	czerwony	+150°C	6	60	77,62

PHA-005/R

PERFEKT SYSTEM
Kurek kulowy ze śrubunkiem

(K) GRUPA RABATOWA

dostępny w III kwartale 2024

PERFEKT² SYSTEM

indeks	wielkość	PN	rodzaj uchwyty	kolor uchwyty	Tmax	pakowanie		cena netto [zł]
00-005-0150-100	½"	30	rączka	czerwony	+150°C	10	120	28,99
00-005-0200-100	¾"	30	rączka	czerwony	+150°C	10	100	45,40
00-005-0250-100	1"	30	rączka	czerwony	+150°C	6	60	77,62
00-005-0320-100	1¼"	30	rączka	czerwony	+150°C	4	24	113,14

PHA-006

PERFEKT SYSTEM
Kurek kulowy z filtrem skośnym

(K) GRUPA RABATOWA

PERFEKT² SYSTEM

indeks	wielkość	PN	rodzaj uchwyty	kolor uchwyty	Tmax	pakowanie		cena netto [zł]
01-006-0150-000	½"	30	rączka	czerwony	+150°C	8	80	37,89
01-006-0200-000	¾"	30	rączka	czerwony	+150°C	6	60	63,46
01-006-0250-000	1"	30	rączka	czerwony	+150°C	4	40	93,19

PHA-007

PERFEKT SYSTEM
Kurek kulowy
ze śrubunkiem

PERFEKT²SYSTEM

indeks	wielkość	PN	rodzaj uchwyty	kolor uchwyty	Tmax	pakowanie		cena netto [zł]
						☞	☞	
00-007-0150-002	½"	30	motylek	czerwony	+140°C	12	120	34,03
00-007-0200-002	¾"	30	motylek	czerwony	+140°C	8	80	52,26
00-007-0250-002	1"	30	motylek	czerwony	+140°C	4	40	88,16



(K) GRUPA RABATOWA

PHA-007/O

PERFEKT SYSTEM
Kurek kulowy
z obrotową nakrętką
z dławikiem



NOWOŚĆ

PERFEKT²SYSTEM

indeks	wielkość	PN	rodzaj uchwyty	kolor uchwyty	Tmax	pakowanie		cena netto [zł]
						☞	☞	
00-007-0150-001	½"	30	motylek	czerwony	+140°C	12	144	33,63
00-007-0200-001	¾"	30	motylek	czerwony	+140°C	10	100	49,66
00-007-0250-001	1"	30	motylek	czerwony	+140°C	6	60	80,00
00-007-0320-001	1¼"	30	motylek	czerwony	+140°C	4	32	120,00



(K) GRUPA RABATOWA

Produkt dostępny w II kwartale 2024

PHA-007/R

PERFEKT SYSTEM
Kurek kulowy
ze śrubunkiem

PERFEKT²SYSTEM

indeks	wielkość	PN	rodzaj uchwyty	kolor uchwyty	Tmax	pakowanie		cena netto [zł]
						☞	☞	
00-007-0150-102	½"	30	rączka	czerwony	+140°C	10	100	34,03
00-007-0200-102	¾"	30	rączka	czerwony	+140°C	6	60	52,26
00-007-0250-102	1"	30	rączka	czerwony	+140°C	4	40	88,16



(K) GRUPA RABATOWA

PHA-007A

PERFEKT SYSTEM
Kurek kulowy
ze śrubunkiem z gwintem
samoszczelniającym

PERFEKT²SYSTEM

indeks	wielkość	PN	rodzaj uchwyty	kolor uchwyty	Tmax	pakowanie		cena netto [zł]
						☞	☞	
00-007-0250-003	1"	30	motylek	czerwony	+140°C	4	40	89,98



(K) GRUPA RABATOWA

PHA-008

PERFEKT SYSTEM
Kurek kulowy z zaworem
spustowym

PERFEKT²SYSTEM

indeks	wielkość	PN	rodzaj uchwyty	kolor uchwyty	Tmax	pakowanie		cena netto [zł]
						☞	☞	
00-008-0150-002	½"	30	rączka	czerwony	+140°C	8	80	38,09
00-008-0200-002	¾"	30	rączka	czerwony	+140°C	6	60	48,39
00-008-0250-002	1"	30	rączka	czerwony	+140°C	4	40	72,06



(K) GRUPA RABATOWA

PHA-010

PERFEKT SYSTEM
Kurek kulowy kątowy
ze śrubunkiem

PERFEKT²SYSTEM

indeks	wielkość	PN	rodzaj uchwyty	kolor uchwyty	Tmax	pakowanie		cena netto [zł]
						☞	☞	
00-010-0150-000	½"	30	motyl	czerwony	+140°C	10	80	37,45
00-010-0200-000	¾"	30	motyl	czerwony	+140°C	6	40	54,98
00-010-0250-000	1"	30	motyl	czerwony	+140°C	5	40	90,76
00-010-0320-000	1¼"	30	motyl	czerwony	+140°C			



dostępny w III kwartale 2024

(K) GRUPA RABATOWA

PHA-010A

PERFEKT SYSTEM
Kurek kulowy kątowy
ze śrubunkiem z gwintem
samoszczelniającym

PERFEKT²SYSTEM

indeks	wielkość	PN	rodzaj uchwyty	kolor uchwyty	Tmax	pakowanie		cena netto [zł]
						☞	☞	
00-010-0250-002	1"	30	motyl	czerwony	+140°C	5	40	92,66
00-010-0250-003	1"	30	motyl	niebieski	+140°C	5	40	92,66



(K) GRUPA RABATOWA

PHA-010/O**PERFEKT SYSTEM**

Kurek kulowy kątowny z obrotową nakrętką

NOWOŚĆ**PERFEKT SYSTEM**

indeks	wielkość	PN	rodzaj uchwytu	kolor uchwytu	Tmax	pakowanie		cena netto [zł]
00-010-0150-001	½"	30	motyl	czerwony	+140°C	12	120	38,30
00-010-0200-001	¾"	30	motyl	czerwony	+140°C	8	80	60,33
00-010-0250-001	1"	30	motyl	czerwony	+140°C	6	48	92,50
00-010-0320-001	1¼"	30	motyl	czerwony	+140°C	4	24	138,55

(K) GRUPA RABATOWA

Produkt dostępny w II kwartale 2024

RN-PHA

Rączka do kurków kulowych PHA-001 i PHA-003, z ergonomiczną rączką, z etykietką na kurku

**PERFEKT SYSTEM**

indeks	kolor	indeks	kolor	wielkość	pakowanie		cena netto [zł]
01-900-1001-150	czerwony	01-900-1011-150	niebieski	½"	1	1	2,00
01-900-1001-200	czerwony	01-900-1011-200	niebieski	¾"	1	1	2,42
01-900-1001-250	czerwony	01-900-1011-250	niebieski	1"	1	1	4,11
01-900-1001-320	czerwony	01-900-1011-320	niebieski	1¼"	1	1	6,29
01-900-1001-400	czerwony	01-900-1011-400	niebieski	1½"	1	1	8,56
01-900-1001-500	czerwony	01-900-1011-500	niebieski	2"	1	1	12,85

(K) GRUPA RABATOWA**MN-PHA**

Motyl do kurków kulowych PHA-002 i PHA-004 z etykietką na kurku

**PERFEKT SYSTEM**

indeks	kolor	indeks	kolor	wielkość	pakowanie		cena netto [zł]
01-900-1010-150	czerwony	01-900-1012-150	niebieski	½"	1	1	2,00
01-900-1010-200	czerwony	01-900-1012-200	niebieski	¾"	1	1	2,42
01-900-1010-250	czerwony	01-900-1012-250	niebieski	1"	1	1	4,11

(K) GRUPA RABATOWA**PHA-200/1****HUZAR**

kurek kulowy WW

**PERFEKT SYSTEM**

indeks	wielkość	PN	rodzaj uchwytu	kolor uchwytu	Tmax	pakowanie		cena netto [zł]
00-006-0150-000	½"	40	rączka	czarny	+180°C	10	90	38,44
00-006-0200-000	¾"	40	rączka	czarny	+180°C	10	60	62,84
00-006-0250-000	1"	40	rączka	czarny	+180°C	6	36	96,34
00-006-0320-000	1¼"	40	rączka	czarny	+180°C	4	24	157,12
00-006-0400-000	1½"	40	rączka	czarny	+180°C	2	18	219,94
00-006-0500-000	2"	40	rączka	czarny	+180°C	2	8	368,64

(K) GRUPA RABATOWA**PHA-200/2****HUZAR**

kurek kulowy WZ

**PERFEKT SYSTEM**

indeks	wielkość	PN	rodzaj uchwytu	kolor uchwytu	Tmax	pakowanie		cena netto [zł]
00-007-0150-000	½"	40	rączka	czarny	+180°C	10	90	37,42
00-007-0200-000	¾"	40	rączka	czarny	+180°C	10	60	61,18
00-007-0250-000	1"	40	rączka	czarny	+180°C	6	36	93,79

(K) GRUPA RABATOWA**PHA-200/3****HUZAR**

kurek kulowy WW

**PERFEKT SYSTEM**

indeks	wielkość	PN	rodzaj uchwytu	kolor uchwytu	Tmax	pakowanie		cena netto [zł]
00-008-0150-000	½"	40	motyl	czarny	+180°C	10	90	36,71
00-008-0200-000	¾"	40	motyl	czarny	+180°C	10	60	60,27
00-008-0250-000	1"	40	motyl	czarny	+180°C	6	36	93,79

(K) GRUPA RABATOWA**PHA-200/4****HUZAR**

kurek kulowy WZ

**PERFEKT SYSTEM**

indeks	wielkość	PN	rodzaj uchwytu	kolor uchwytu	Tmax	pakowanie		cena netto [zł]
00-009-0150-000	½"	40	motyl	czarny	+180°C	10	90	37,42
00-009-0200-000	¾"	40	motyl	czarny	+180°C	10	60	61,18
00-009-0250-000	1"	40	motyl	czarny	+180°C	6	36	93,79

(K) GRUPA RABATOWA

KX01**KROS**
kurek kulowy WW

GRUPA RABATOWA

indeks	wielkość	PN	rodzaj uchwytu	kolor uchwytu	Tmax	pakowanie		cena netto [zł]
KX01-0150-000	½"	30	rączka	czerwony	+130°C	15	150	20,18
KX01-0200-000	¾"	30	rączka	czerwony	+130°C	10	100	29,37
KX01-0250-000	1"	30	rączka	czerwony	+130°C	6	60	46,26
KX01-0320-000	1¼"	30	rączka	czerwony	+130°C	4	40	74,17
KX01-0400-000	1½"	30	rączka	czerwony	+130°C	4	32	109,47
KX01-0500-000	2"	30	rączka	czerwony	+130°C	2	20	168,05
KX01-0650-000	2½"	30	rączka	czerwony	+130°C	2	10	342,11

**KX02****KROS**
kurek kulowy WW

GRUPA RABATOWA

indeks	wielkość	PN	rodzaj uchwytu	kolor uchwytu	Tmax	pakowanie		cena netto [zł]
KX02-0150-000	½"	30	motyl	czerwony	+130°C	15	150	20,38
KX02-0200-000	¾"	30	motyl	czerwony	+130°C	10	100	29,98
KX02-0250-000	1"	30	motyl	czerwony	+130°C	6	60	47,80

**KX03****KROS**
kurek kulowy WZ

GRUPA RABATOWA

indeks	wielkość	PN	rodzaj uchwytu	kolor uchwytu	Tmax	pakowanie		cena netto [zł]
KX03-0150-000	½"	30	rączka	czerwony	+130°C	15	150	21,18
KX03-0200-000	¾"	30	rączka	czerwony	+130°C	10	100	31,20
KX03-0250-000	1"	30	rączka	czerwony	+130°C	6	60	49,04

**KX04****KROS**
kurek kulowy WZ

GRUPA RABATOWA

indeks	wielkość	PN	rodzaj uchwytu	kolor uchwytu	Tmax	pakowanie		cena netto [zł]
KX04-0150-000	½"	30	motyl	czerwony	+130°C	15	150	20,50
KX04-0200-000	¾"	30	motyl	czerwony	+130°C	10	100	31,53
KX04-0250-000	1"	30	motyl	czerwony	+130°C	6	60	52,03

**KX06****KROS**
kurek kulowy z filtrem skośnym

GRUPA RABATOWA

indeks	wielkość	PN	rodzaj uchwytu	kolor uchwytu	Tmax	pakowanie		cena netto [zł]
KX06-0250-000	1"	10	rączka	czerwony	+120°C	4	40	76,29

**1040WW**

Kurek kulowy WW



GRUPA RABATOWA

indeks	wielkość	PN	rodzaj uchwytu	kolor uchwytu	Tmax	pakowanie		cena netto [zł]
00-200-0150-010	½"	16	rączka	czerwony	+120°C	16	160	19,52
00-200-0200-010	¾"	16	rączka	czerwony	+120°C	12	120	27,05
00-200-0250-010	1"	16	rączka	czerwony	+120°C	6	60	44,07
00-200-0320-010	1¼"	16	rączka	czerwony	+120°C	4	40	67,43
00-200-0400-010	1½"	16	rączka	czerwony	+120°C	4	32	103,26
00-200-0500-010	2"	16	rączka	czerwony	+120°C	2	20	170,89

**1041WW**

Kurek kulowy WW



GRUPA RABATOWA

indeks	wielkość	PN	rodzaj uchwytu	kolor uchwytu	Tmax	pakowanie		cena netto [zł]
00-220-0150-010	½"	16	motyl	czerwony	+120°C	16	160	20,06
00-220-0200-010	¾"	16	motyl	czerwony	+120°C	12	120	27,30
00-220-0250-010	1"	16	motyl	czerwony	+120°C	6	60	46,41



1040WZ

Kurek kulowy WZ



(A) GRUPA RABATOWA

indeks	wielkość	PN	rodzaj uchwytu	kolor uchwytu	Tmax	pakowanie		cena netto [zł]
00-202-0150-010	½"	16	rączka	czerwony	+120°C	16	160	19,83
00-202-0200-010	¾"	16	rączka	czerwony	+120°C	12	120	28,38
00-202-0250-010	1"	16	rączka	czerwony	+120°C	6	60	47,63

**1041WZ**

Kurek kulowy WZ



(A) GRUPA RABATOWA

indeks	wielkość	PN	rodzaj uchwytu	kolor uchwytu	Tmax	pakowanie		cena netto [zł]
00-222-0150-010	½"	16	motyl	czerwony	+120°C	16	160	20,72
00-222-0200-010	¾"	16	motyl	czerwony	+120°C	12	120	28,13
00-222-0250-010	1"	16	motyl	czerwony	+120°C	6	60	48,22

**1410WW**

Kurek kulowy z dławikiem WW



(A) GRUPA RABATOWA

indeks	wielkość	PN	rodzaj uchwytu	kolor uchwytu	Tmax	pakowanie		cena netto [zł]
00-200-0650-000	2½"	10	rączka	czerwony	+120°C	2	10	299,30
00-200-0800-000	3"	10	rączka	czerwony	+120°C	2	4	445,16
00-200-1000-000	4"	10	rączka	czerwony	+120°C	2	4	728,84

**1504**

Kurek kulowy do wlotowania



(E) GRUPA RABATOWA

Produkt dostępny do wyczerpania zapasów

indeks	wielkość	PN	rodzaj uchwytu	kolor uchwytu	Tmax	pakowanie		cena netto [zł]
01-304-0150-000	15	10	rączka	czerwony	+120°C	16	160	21,74
01-304-0280-000	28	10	rączka	czerwony	+120°C	6	60	57,42

**65RU**

Kurek kulowy z zaworem spustowym WW

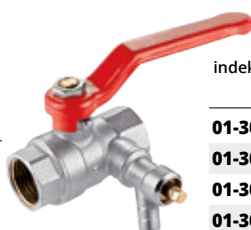

(E) GRUPA RABATOWA

indeks	wielkość	PN	rodzaj uchwytu	kolor uchwytu	Tmax	pakowanie		cena netto [zł]
01-303-0150-000	½"	30	rączka	czerwony	+120°C	8	80	35,24
01-303-0200-000	¾"	30	rączka	czerwony	+120°C	6	60	44,69
01-303-0250-000	1"	30	rączka	czerwony	+120°C	4	40	65,92
01-303-0320-000	1¼"	25	rączka	czerwony	+120°C	2	32	103,32
01-303-0400-000	1½"	25	rączka	czerwony	+120°C	2	24	149,01
01-303-0500-000	2"	25	rączka	czerwony	+120°C	2	16	218,56

**PHA-019D****PERFEKT SYSTEM**

Kurek kul. z dław. ze złączką do łączenia z rurą PEX lub PERT



(K) GRUPA RABATOWA

PERFEKT^{SYSTEM}

indeks	wielkość	PN	rodzaj uchwytu	kolor uchwytu	Tmax	pakowanie		cena netto [zł]
01-019-0000-001	½"	16	rączka	czerwony	+120°C	17	170	20,38
01-019-1000-001	½"	16	rączka	niebieski	+120°C	17	170	20,38

**PHA-019S****PERFEKT SYSTEM**

Kurek kulowy spustowy z dławikiem ze złączką do węży



(K) GRUPA RABATOWA

PERFEKT^{SYSTEM}

indeks	wielkość	PN	rodzaj uchwytu	kolor uchwytu	Tmax	pakowanie		cena netto [zł]
01-019-0000-002	½"	16	rączka	czerwony	+120°C	25	250	20,97
01-019-1000-002	½"	16	rączka	niebieski	+120°C	25	250	20,97



1809

Kurek kulowy spustowy
ze złączką do węża

indeks	wielkość	PN	rodzaj uchwyty	kolor uchwyty	Tmax	pakowanie		cena netto [zł]
20-205-0150-000	½"	25	rączka	czerwony	+150°C	15	150	28,14
20-205-0200-000	¾"	25	rączka	czerwony	+150°C	15	120	39,34

(E) GRUPA RABATOWA



3021WW

Kurek kulowy
typ MINI WW

indeks	wielkość	PN	rodzaj uchwyty	kolor uchwyty	Tmax	pakowanie		cena netto [zł]
01-301-0150-000	½"	16	rączka	czerwony	+120°C	20	180	19,76

(E) GRUPA RABATOWA



3021WZ

Kurek kulowy
typ MINI WZ

indeks	wielkość	PN	rodzaj uchwyty	kolor uchwyty	Tmax	pakowanie		cena netto [zł]
01-302-0150-001	½"	16	rączka	czerwony	+120°C	25	250	19,08

(E) GRUPA RABATOWA



428CH

Kurek kulowy
podtynkowy

indeks	wielkość	PN	Tmax	pakowanie		cena netto [zł]
01-305-0150-000	½"	30	+120°C	5	50	66,13
01-305-0200-000	¾"	30	+120°C	4	40	76,96

(E) GRUPA RABATOWA



PHA-060

PERFEKT SYSTEM
Filtr skośny do wody

indeks	wielkość	PN	Tmax	pakowanie		cena netto [zł]
03-060-0150-000	½"	25	+150°C	18	180	19,74
03-060-0200-000	¾"	25	+150°C	12	120	31,25
03-060-0250-000	1"	25	+150°C	10	100	42,97
03-060-0320-000	1¼"	25	+150°C	4	40	82,97
03-060-0400-000	1½"	25	+150°C	3	30	109,37
03-060-0500-000	2"	25	+150°C	2	20	178,51
03-060-0650-000	2½"	20	+150°C	1	10	284,27
03-060-0800-000	3"	20	+150°C	1	10	446,36

(K) GRUPA RABATOWA



PHA-060M

PERFEKT SYSTEM
Filtr skośny do wody
z wkładem magnetycznym

indeks	wielkość	PN	Tmax	pakowanie		cena netto [zł]
03-060-0150-100	½"	25	+150°C	18	180	46,00
03-060-0200-100	¾"	25	+150°C	12	120	56,00
03-060-0250-100	1"	25	+150°C	10	100	65,00
03-060-0320-100	1¼"	25	+150°C	4	10	210,24
03-060-0400-100	1½"	25	+150°C	3	10	239,26
03-060-0500-100	2"	25	+150°C	2	10	368,83

(K) GRUPA RABATOWA

dostępne w III kwartale 2024



US-060

Uszczelka i siatka do filtra
PHA-060



(K) GRUPA RABATOWA

PERFEKT^{SYSTEM}

indeks	wielkość	pakowanie		cena netto [zł]
03-200-0000-150	½"	1	1	1,80
03-200-0000-200	¾"	1	1	2,76
03-200-0000-250	1"	1	1	3,59
03-200-0000-320	1¼"	1	1	7,15
03-200-0000-400	1½"	1	1	9,49
03-200-0000-500	2"	1	1	13,77
03-200-0000-650	2½"	1	1	16,00
03-200-0000-800	3"	1	1	21,00

5503

Zawór zwrotny
z mosiężnym grzybkiem



(B) GRUPA RABATOWA

indeks	wielkość	PN	Tmax	pakowanie		cena netto [zł]
04-100-0150-000	½"	10	+120°C	16	192	19,29
04-100-0200-000	¾"	10	+120°C	10	150	24,78
04-100-0250-000	1"	10	+120°C	9	108	32,52
04-100-0320-000	1¼"	10	+120°C	6	48	58,21
04-100-0400-000	1½"	10	+120°C	2	40	77,67
04-100-0500-000	2"	10	+120°C	2	30	116,55
04-100-0650-000	2½"	8	+120°C	2	10	194,30

5503/P

Zawór zwrotny
z grzybkiem z tworzywa



(B) GRUPA RABATOWA

indeks	wielkość	PN	Tmax	pakowanie		cena netto [zł]
04-100-0150-100	½"	10	+120°C	16	192	18,20
04-100-0200-100	¾"	10	+120°C	10	150	23,86
04-100-0250-100	1"	10	+120°C	9	108	31,57
04-100-0320-100	1¼"	10	+120°C	6	48	57,05
04-100-0400-100	1½"	10	+120°C	2	40	76,17
04-100-0500-100	2"	10	+120°C	2	30	114,26

PHA-020

PERFEKT SYSTEM
Zawór zwrotny
z mosiężnym grzybkiem



(K) GRUPA RABATOWA

PERFEKT^{SYSTEM}

indeks	wielkość	PN	Tmax	pakowanie		cena netto [zł]
04-020-0150-000	½"	16	+120°C	19	228	21,36
04-020-0200-000	¾"	16	+120°C	12	144	29,54
04-020-0250-000	1"	16	+120°C	9	108	42,15
04-020-0320-000	1¼"	10	+120°C	6	72	61,53
04-020-0400-000	1½"	10	+120°C	6	36	94,60
04-020-0500-000	2"	10	+120°C	1	30	133,37
04-020-0650-000	2½"	10	+120°C	1	16	283,25
04-020-0800-000	3"	10	+120°C	1	12	387,81
04-020-1000-000	4"	10	+120°C	1	4	652,52

PHA-KS1

PERFEKT SYSTEM
Kosz ssawny do zaworu
zwrotnego PHA-020



(K) GRUPA RABATOWA

PERFEKT^{SYSTEM}

indeks	wielkość	pakowanie		cena netto [zł]
04-901-0150-000	½"	54	648	5,00
04-901-0200-000	¾"	28	336	6,84
04-901-0250-000	1"	30	180	9,09
04-901-0320-000	1¼"	20	120	11,21
04-901-0400-000	1½"	6	72	12,93
04-901-0500-000	2"	4	48	16,79
04-901-0650-000	2½"	1	28	29,56
04-901-0800-000	3"	1	22	34,09
04-901-1000-000	4"	1	12	49,64

PHA-021

PERFEKT SYSTEM

Zawór zwrotny klapkowy



GRUPA RABATOWA

PERFEKT^{SYSTEM}

indeks	wielkość	PN	Tmax	pakowanie		cena netto [zł]
04-021-0150-000	½"	16	+120°C	12	144	27,46
04-021-0200-000	¾"	16	+120°C	10	80	37,32
04-021-0250-000	1"	16	+120°C	8	96	53,52
04-021-0320-000	1¼"	10	+120°C	6	36	94,12
04-021-0400-000	1½"	10	+120°C	4	24	118,92
04-021-0500-000	2"	10	+120°C	2	12	164,35
04-021-0650-000	2½"	10	+120°C	1	12	280,49
04-021-0800-000	3"	10	+120°C	1	8	411,37

PHA-013

PERFEKT SYSTEM

Zawór antyskażeniowy typ "EA"



GRUPA RABATOWA

PERFEKT^{SYSTEM}

indeks	wielkość	PN	Tmax	pakowanie		cena netto [zł]
01-013-0150-000	½"	10	+65°C	18	180	24,39
01-013-0200-000	¾"	10	+65°C	16	128	32,40
01-013-0250-000	1"	10	+65°C	10	180	49,09

PHA-022

PERFEKT SYSTEM

Zasuwa mosiężna



GRUPA RABATOWA

PERFEKT^{SYSTEM}

indeks	wielkość	PN	Tmax	pakowanie		cena netto [zł]
01-022-0150-000	½"	10	+100°C	20	80	30,72
01-022-0200-000	¾"	10	+100°C	15	60	41,22
01-022-0250-000	1"	10	+100°C	8	48	60,96
01-022-0320-000	1¼"	10	+100°C	2	24	90,55
01-022-0400-000	1½"	10	+100°C	2	24	119,37
01-022-0500-000	2"	10	+100°C	3	12	190,34
01-022-0650-000	2½"	10	+100°C	2	12	345,16
01-022-0800-000	3"	10	+100°C	2	8	474,11

1620

Zawór antyskażeniowy skośny

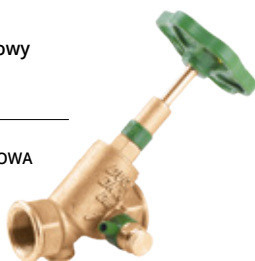

GRUPA RABATOWA

indeks	wielkość	PN	Tmax	pakowanie		cena netto [zł]
01-402-0150-000	½"	10	+90°C	1	20	89,13
01-402-0200-000	¾"	10	+90°C	1	10	109,60
01-402-0250-000	1"	10	+90°C	1	5	139,85
01-402-0320-000	1¼"	10	+90°C	1	4	246,13
01-402-0400-000	1½"	10	+90°C	1	1	289,01
01-402-0500-000	2"	10	+90°C	1	1	447,47

1505

Zawór przepływowy skośny

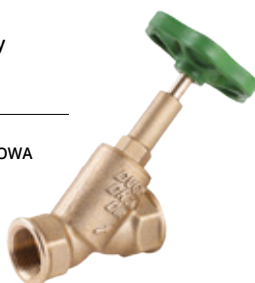

GRUPA RABATOWA

indeks	wielkość	PN	Tmax	pakowanie		cena netto [zł]
01-401-0150-000	½"	10	+90°C	1	20	35,82
01-401-0200-000	¾"	10	+90°C	1	10	56,75
01-401-0250-000	1"	10	+90°C	1	5	74,47
01-401-0320-000	1¼"	10	+90°C	1	4	151,17
01-401-0400-000	1½"	10	+90°C	1	1	174,73
01-401-0500-000	2"	10	+90°C	1	1	311,00

1105

Zawór przepływowy grzybkowy prosty



GRUPA RABATOWA

indeks	wielkość	PN	Tmax	pakowanie		cena netto [zł]
01-400-0150-000	½"	10	+90°C	1	20	42,54
01-400-0200-000	¾"	10	+90°C	1	15	58,01
01-400-0250-000	1"	10	+90°C	1	10	91,63
01-400-0320-000	1¼"	10	+90°C	1	5	155,55
01-400-0400-000	1½"	10	+90°C	1	3	222,69
01-400-0500-000	2"	10	+90°C	1	1	323,94

ZKR-111

Zawór zwrotny kulowy różnicowy

**(D)** GRUPA RABATOWA

indeks	wielkość	PN	Tmax	pakowanie		cena netto [zł]
04-101-0250-000	1"	6	+120°C	1	24	70,34
04-101-0320-000	1¼"	6	+120°C	1	18	78,08
04-101-0400-000	1½"	6	+120°C	1	16	90,36
04-101-0500-000	2"	6	+120°C	1	12	111,54

**G02**

Głowica do zaworów żeliwnych z uszczelką płaską fibrową

**(B)** GRUPA RABATOWA

indeks	wielkość	PN	Tmax	pakowanie		cena netto [zł]
01-500-0150-000	½"	10	+90°C	20	120	16,07
01-500-0200-000	¾"	10	+90°C	20	120	19,80
01-500-0250-000	1"	10	+90°C	15	60	27,20
01-500-0320-000	1¼"	10	+90°C	10	80	58,47
01-500-0400-000	1½"	10	+90°C	5	60	71,12
01-500-0500-000	2"	10	+90°C	5	30	111,51

**3098**

Zawór żeliwny ocynkowany przelotowy prosty

**(B)** GRUPA RABATOWA

indeks	wielkość	PN	Tmax	pakowanie		cena netto [zł]
01-400-0150-100	½"	10	+120°C	8	64	24,00
01-400-0200-100	¾"	10	+120°C	8	48	31,00
01-400-0250-100	1"	10	+120°C	4	24	46,50
01-400-0320-100	1¼"	10	+120°C	3	18	92,30
01-400-0400-100	1½"	10	+120°C	4	16	134,34
01-400-0500-100	2"	10	+120°C	2	8	227,33

**3099**

Zawór żeliwny ocynkowany czerpalny z szybkozłączką do węża

**(B)** GRUPA RABATOWA

indeks	wielkość	PN	Tmax	pakowanie		cena netto [zł]
01-009-0150-005	½"	10	+120°C	8	32	33,43
01-009-0200-005	¾"	10	+120°C	7	28	48,47

**PHA-070**

Kurek kulowy czerpalny mrozoodporny

**(K)** GRUPA RABATOWA**PERFEKT**^{SYSTEM}

indeks	wielkość	PN	Tmax	pakowanie		cena netto [zł]
01-070-0150-000	½"	15	+120°C	12	120	29,36
01-070-0200-000	¾"	20	+120°C	10	100	40,17

**3102**

Kurek kulowy czerpalny ze złączką do węża

**(B)** GRUPA RABATOWA

indeks	wielkość	PN	Tmax	pakowanie		cena netto [zł]
01-009-0150-002	½"	10	+80°C	10	100	23,92
01-009-0200-002	¾"	10	+80°C	10	100	33,22
01-009-0250-002	1"	10	+80°C	5	40	53,74



PHA-009**PERFEKT SYSTEM**

Kurek kulowy czerpalny z dławikiem ze złączką do węża

(K) GRUPA RABATOWA**PERFEKT** SYSTEM

indeks	wielkość	PN	Tmax	pakowanie		cena netto [zł]
01-009-0150-000	½"	16	+120°C	10	100	26,33
01-009-0200-000	¾"	16	+120°C	10	100	37,14
01-009-0250-000	1"	16	+120°C	5	40	61,56

PHA-009 DUO**PERFEKT SYSTEM**

Kurek kulowy czerpalny podwójny

(K) GRUPA RABATOWA**PERFEKT** SYSTEM

indeks	wielkość	PN	Tmax	pakowanie		cena netto [zł]
01-009-0150-006	½"	16	+120°C			

Produkt dostępny w III kwartale 2024

PHA-009S**PERFEKT SYSTEM**

Kurek kulowy czerpalny z dławikiem z szybkozłączką do węża

(K) GRUPA RABATOWA**PERFEKT** SYSTEM

indeks	wielkość	PN	Tmax	pakowanie		cena netto [zł]
01-009-0150-001	½"	16	+120°C	10	100	26,33
01-009-0200-001	¾"	16	+120°C	10	100	37,14

PHA-015**PERFEKT SYSTEM**

Zawór czerpalny grzybkowy mosiężny chromowany

(K) GRUPA RABATOWA**PERFEKT** SYSTEM

indeks	wielkość	PN	Tmax	pakowanie		cena netto [zł]
01-015-0150-000	½"	10	+90°C	1	48	51,58

Adapter

Adapter (redukcja) do zbiornika IBC

(B) GRUPA RABATOWA

indeks	wielkość	Tmax	pakowanie		cena netto [zł]
01-009-0150-010	½"	+65°C	1	300	24,10
01-009-0200-010	¾"	+65°C	1	300	24,10
01-009-0250-010	1"	+65°C	1	300	24,10

Adapter z króćcem

Adapter(redukcja) do zbiornika IBC z króćcem na wąż

(B) GRUPA RABATOWA

indeks	średnica trzpienia	Tmax	pakowanie		cena netto [zł]
01-009-0140-010	Ø14	+65°C	1	170	31,59

09 - Kurek z adapterem

Kurek kulowy czerpalny z adapterem (redukcją) do zbiornika IBC

(K) GRUPA RABATOWA

indeks	wielkość	Tmax	pakowanie	cena netto [zł]
01-009-0150-011	1/2"	+65°C	1	49,09
01-009-0200-011	3/4"	+65°C	1	53,41

**Końcówka do kurka PHA-009S**

Końcówka do kurka

(B) GRUPA RABATOWA

indeks	wielkość	pakowanie	cena netto [zł]
01-900-0150-001	1/2"	10 1000	3,08

**3110**

Końcówka do węża

(B) GRUPA RABATOWA

indeks	wielkość	pakowanie	cena netto [zł]
01-900-0150-000	1/2"	10 1200	2,85
01-900-0200-000	3/4"	10 900	4,60
01-900-0250-000	1"	15 450	6,82

**PHA-304**

Nypel mosiężny wzmocniony

(K) GRUPA RABATOWA**PERFEKT²SYSTEM**

indeks	wielkość	PN	Tmax	pakowanie	cena netto [zł]
07-004-0100-000	3/8"	16	+180°C	20 500	3,40
07-004-0150-000	1/2"	16	+180°C	20 500	5,31
07-004-0200-000	3/4"	16	+180°C	20 400	8,54
07-004-0250-000	1"	16	+180°C	20 100	15,42
07-004-0320-000	1 1/4"	16	+180°C	10 50	25,59
07-004-0400-000	1 1/2"	16	+180°C	10 50	34,31
07-004-0500-000	2"	16	+180°C	5 50	52,22

PHA-304/S

Nypel mosiężny wzmocniony pod uszczelkę płaską

(K) GRUPA RABATOWA**PERFEKT²SYSTEM**

indeks	wielkość	PN	Tmax	pakowanie	cena netto [zł]
07-004-0150-100	1/2"	16	+180°C	20 400	5,97
07-004-0200-100	3/4"	16	+180°C	20 260	9,30
07-004-0250-100	1"	16	+180°C	10 130	17,00

PHA-305

Mufa mosiężna wzmocniona

(K) GRUPA RABATOWA**PERFEKT²SYSTEM**

indeks	wielkość	PN	Tmax	pakowanie	cena netto [zł]
07-005-0100-000	3/8"	16	+180°C	10 200	3,71
07-005-0150-000	1/2"	16	+180°C	20 400	7,88
07-005-0200-000	3/4"	16	+180°C	20 300	10,94
07-005-0250-000	1"	16	+180°C	10 100	20,54
07-005-0320-000	1 1/4"	16	+180°C	10 50	34,51
07-005-0400-000	1 1/2"	16	+180°C	10 50	37,96
07-005-0500-000	2"	16	+180°C	10 30	49,23

PHA-306Redukcja mosiężna
wzmocniona**(K)** GRUPA RABATOWA**PERFEKT²**_{SYSTEM}

indeks	wielkość	PN	Tmax	pakowanie	cena netto [zł]
07-006-1510-000	½" x ¾"	16	+180°C	20 500	3,27
07-006-2015-000	¾" x ½"	16	+180°C	20 800	5,27
07-006-2515-000	1" x ½"	16	+180°C	20 400	11,77
07-006-2520-000	1" x ¾"	16	+180°C	20 400	9,40
07-006-3220-000	1¼" x ¾"	16	+180°C	10 200	21,98
07-006-3225-000	1¼" x 1"	16	+180°C	10 200	17,01
07-006-4025-000	1½" x 1"	16	+180°C	10 100	32,13
07-006-4032-000	1½" x 1¼"	16	+180°C	10 100	19,33
07-006-5025-000	2" x 1"	16	+180°C	10 50	57,35
07-006-5032-000	2" x 1¼"	16	+180°C	10 50	51,84
07-006-5040-000	2" x 1½"	16	+180°C	10 50	48,83

PHA-307Nypel redukcyjny mosiężny
wzmocniony**(K)** GRUPA RABATOWA**PERFEKT²**_{SYSTEM}

indeks	wielkość	PN	Tmax	pakowanie	cena netto [zł]
07-007-1510-000	½" x ¾"	16	+180°C	20 500	5,15
07-007-2015-000	¾" x ½"	16	+180°C	20 400	8,37
07-007-2515-000	1" x ½"	16	+180°C	20 200	14,53
07-007-2520-000	1" x ¾"	16	+180°C	20 200	15,16
07-007-3225-000	1¼" x 1"	16	+180°C	10 150	25,85
07-007-4025-000	1½" x 1"	16	+180°C	10 150	35,26
07-007-5025-000	2" x 1"	16	+180°C	10 100	56,45
07-007-5032-000	2" x 1¼"	16	+180°C	10 100	57,56
07-007-5040-000	2" x 1½"	16	+180°C	10 100	55,55

PHA-308Redukcja mufowo-nypłowa
mosiężna wzmocniona**(K)** GRUPA RABATOWA**PERFEKT²**_{SYSTEM}

indeks	wielkość	PN	Tmax	pakowanie	cena netto [zł]
07-008-1510-000	½" x ¾"	16	+180°C	20 200	5,74
07-008-2015-000	¾" x ½"	16	+180°C	20 400	8,69
07-008-2520-000	1" x ¾"	16	+180°C	10 200	14,64

PHA-309Mufa redukcyjna mosiężna
wzmocniona**(K)** GRUPA RABATOWA**PERFEKT²**_{SYSTEM}

indeks	wielkość	PN	Tmax	pakowanie	cena netto [zł]
07-009-1510-000	½" x ¾"	16	+180°C	20 200	5,19
07-009-2015-000	¾" x ½"	16	+180°C	20 400	8,62
07-009-2520-000	1" x ¾"	16	+180°C	10 200	16,72

PHA-310Kolano mosiężne
wzmocnione**(K)** GRUPA RABATOWA**PERFEKT²**_{SYSTEM}

indeks	wielkość	PN	Tmax	pakowanie	cena netto [zł]
07-010-0100-000	¾"	16	+180°C	20 400	6,49
07-010-0150-000	½"	16	+180°C	20 200	9,60
07-010-0200-000	¾"	16	+180°C	20 200	14,85
07-010-0250-000	1"	16	+180°C	20 100	30,81
07-010-0320-000	1¼"	16	+180°C	10 50	46,32
07-010-0400-000	1½"	16	+180°C	10 50	69,69
07-010-0500-000	2"	16	+180°C	10 50	98,60

PHA-311

Kolano mosiężne
wzmocnione WZ**(K)** GRUPA RABATOWAPERFEKT^{SYSTEM}

indeks	wielkość	PN	Tmax	pakowanie		cena netto [zł]
07-011-0100-000	3/8"	16	+180°C	10	200	6,41
07-011-0150-000	1/2"	16	+180°C	20	400	9,43
07-011-0200-000	3/4"	16	+180°C	20	300	15,74
07-011-0250-000	1"	16	+180°C	20	200	29,30
07-011-0320-000	1 1/4"	16	+180°C	10	50	48,28
07-011-0400-000	1 1/2"	16	+180°C	10	50	68,57
07-011-0500-000	2"	16	+180°C	10	50	100,14

PHA-312

Trójnik mosiężny
wzmocniony**(K)** GRUPA RABATOWAPERFEKT^{SYSTEM}

indeks	wielkość	PN	Tmax	pakowanie		cena netto [zł]
07-012-0100-000	3/8"	16	+180°C	10	100	7,94
07-012-0150-000	1/2"	16	+180°C	20	200	11,67
07-012-0200-000	3/4"	16	+180°C	20	200	19,61
07-012-0250-000	1"	16	+180°C	20	100	39,87
07-012-0320-000	1 1/4"	16	+180°C	10	50	56,57
07-012-0400-000	1 1/2"	16	+180°C	10	50	85,88
07-012-0500-000	2"	16	+180°C	10	50	122,39

PHA-313

Trójnik mosiężny
wzmocniony WZ**(K)** GRUPA RABATOWAPERFEKT^{SYSTEM}

indeks	wielkość	PN	Tmax	pakowanie		cena netto [zł]
07-013-0100-000	3/8"	16	+180°C	10	100	6,58
07-013-0150-000	1/2"	16	+180°C	10	100	11,37
07-013-0200-000	3/4"	16	+180°C	10	100	18,54
07-013-0250-000	1"	16	+180°C	10	100	38,13

PHA-314

Trójnik redukcyjny
mosiężny wzmocniony**(K)** GRUPA RABATOWAPERFEKT^{SYSTEM}

indeks	wielkość	PN	Tmax	pakowanie		cena netto [zł]
07-014-2015-000	3/4" x 1/2"	16	+180°C	10	100	19,33
07-014-2515-000	1" x 1/2"	16	+180°C	10	100	33,54
07-014-2520-000	1" x 3/4"	16	+180°C	10	100	36,52

PHA-315

Przedłużka mosiężna
wzmocniona WZ**(K)** GRUPA RABATOWAPERFEKT^{SYSTEM}

indeks	wielkość	PN	Tmax	pakowanie		cena netto [zł]
07-015-1015-000	1/2" x 10	16	+180°C	20	540	6,83
07-015-1515-000	1/2" x 15	16	+180°C	20	540	8,21
07-015-2015-000	1/2" x 20	16	+180°C	20	320	10,09
07-015-2515-000	1/2" x 25	16	+180°C	20	320	11,86
07-015-3015-000	1/2" x 30	16	+180°C	20	320	13,52
07-015-4015-000	1/2" x 40	16	+180°C	20	320	17,62
07-015-5015-000	1/2" x 50	16	+180°C	20	240	21,78

PHA-316

korek wzmocniony



(K) GRUPA RABATOWA

PERFEKT^{SYSTEM}

indeks	wielkość	PN	Tmax	pakowanie		cena netto [zł]
07-016-0320-000	1¼"	16	+120°C	10	180	17,70
07-016-0400-000	1½"	16	+120°C	5	180	20,95

PHA-318

Trójnik wzmocniony pod odpowietrznik



(K) GRUPA RABATOWA

PERFEKT^{SYSTEM}

indeks	wielkość	PN	Tmax	pakowanie		cena netto [zł]
07-018-2515-000	1 x 1 x ½"	16	+120°C	5	60	33,10

PHA-300

Śrubunek prosty o-ring mosiężny wzmocniony



(K) GRUPA RABATOWA

PERFEKT^{SYSTEM}

indeks	wielkość	PN	Tmax	pakowanie		cena netto [zł]
07-000-0150-000	½" L-55mm	16	+120°C	20	200	19,16
07-000-0200-000	¾" L-60mm	16	+120°C	12	120	30,45
07-000-0250-000	1" L-65mm	16	+120°C	8	80	55,29

PHA-301

Śrubunek prosty stożek mosiężny wzmocniony



(K) GRUPA RABATOWA

PERFEKT^{SYSTEM}

indeks	wielkość	PN	Tmax	pakowanie		cena netto [zł]
07-001-0150-000	½" L-55mm	16	+120°C	20	200	19,51
07-001-0200-000	¾" L-60mm	16	+120°C	12	120	30,45
07-001-0250-000	1" L-65mm	16	+120°C	8	80	55,29

502G

Przedłużka mosiężna WZ



(D) GRUPA RABATOWA



indeks	wielkość	PN	Tmax	pakowanie		cena netto [zł]
07-220-1510-000	½" x 10	16	+180°C	20	540	4,59
07-220-1515-000	½" x 15	16	+180°C	20	540	5,51
07-220-1520-000	½" x 20	16	+180°C	20	320	6,82
07-220-1525-000	½" x 25	16	+180°C	20	320	8,01
07-220-1530-000	½" x 30	16	+180°C	20	320	9,31
07-220-1540-000	½" x 40	16	+180°C	20	320	10,72
07-220-1550-000	½" x 50	16	+180°C	20	240	14,06
07-220-1560-000	½" x 60	16	+180°C	20	160	17,26
07-220-1580-000	½" x 80	16	+180°C	20	160	21,65
07-220-1599-000	½" x 100	16	+180°C	20	120	26,37
07-220-2010-000	¾" x 10	16	+180°C	10	550	6,43
07-220-2015-000	¾" x 15	16	+180°C	20	320	7,95
07-220-2020-000	¾" x 20	16	+180°C	20	320	9,30
07-220-2030-000	¾" x 30	16	+180°C	10	260	12,77
07-220-2040-000	¾" x 40	16	+180°C	20	180	15,67
07-220-2050-000	¾" x 50	16	+180°C	20	180	18,10

5101

Korek mosiężny GZ



indeks	wielkość	PN	Tmax	pakowanie	cena netto [zł]
07-201-0100-000	3/8"	16	+180°C	50 1000	3,84
07-201-0150-000	1/2"	16	+180°C	50 1000	3,58
07-201-0200-000	3/4"	16	+180°C	50 500	5,85
07-201-0250-000	1"	16	+180°C	5 250	10,54

GRUPA RABATOWA



5102

Zasłepka mosiężna GW



indeks	wielkość	PN	Tmax	pakowanie	cena netto [zł]
07-202-0100-000	3/8"	16	+180°C	50 800	3,84
07-202-0150-000	1/2"	16	+180°C	50 800	3,58
07-202-0200-000	3/4"	16	+180°C	130 520	5,85
07-202-0250-000	1"	16	+180°C	50 400	12,78
07-202-0320-000	1 1/4"	16	+180°C	1 1	17,01

GRUPA RABATOWA



5105

Nypel mosiężny



indeks	wielkość	PN	Tmax	pakowanie	cena netto [zł]
07-205-0100-000	3/8"	16	+180°C	100 1200	2,79
07-205-0150-000	1/2"	16	+180°C	100 600	4,23
07-205-0200-000	3/4"	16	+180°C	50 400	7,51
07-205-0250-000	1"	16	+180°C	20 160	13,79
07-205-0320-000	1 1/4"	16	+180°C	10 120	18,34

GRUPA RABATOWA



5108

Mufa mosiężna



indeks	wielkość	PN	Tmax	pakowanie	cena netto [zł]
07-208-0150-000	1/2"	16	+180°C	100 600	6,32
07-208-0200-000	3/4"	16	+180°C	50 400	8,79
07-208-0250-000	1"	16	+180°C	20 240	15,18
07-208-0320-000	1 1/4"	16	+180°C	10 120	24,56

GRUPA RABATOWA



5109

Nypel redukcyjny mosiężny



indeks	wielkość	PN	Tmax	pakowanie	cena netto [zł]
07-209-1510-000	3/8" x 1/2"	16	+180°C	100 800	4,03
07-209-1520-000	1/2" x 3/4"	16	+180°C	50 400	6,27
07-209-2025-000	3/4" x 1"	16	+180°C	50 300	11,36

GRUPA RABATOWA



5110

Redukcja mosiężna



indeks	wielkość	PN	Tmax	pakowanie	cena netto [zł]
07-210-1008-000	3/8" x 1/4"	16	+180°C	100 1200	3,36
07-210-1508-000	1/2" x 1/4"	16	+180°C	50 500	4,42
07-210-1510-000	1/2" x 3/8"	16	+180°C	100 1200	2,53
07-210-1525-000	1/2" x 1"	16	+180°C	50 400	9,82
07-210-2015-000	3/4" x 1/2"	16	+180°C	50 600	4,46
07-210-2025-000	3/4" x 1"	16	+180°C	50 400	7,09
07-210-2532-000	1" x 1 1/4"	16	+180°C	20 160	16,26

GRUPA RABATOWA



5111

Redukcja mufowo-nyplowa mosiężna



indeks	wielkość	PN	Tmax	pakowanie	cena netto [zł]
07-211-1510-000	3/8" x 1/2"	16	+180°C	50 800	4,49
07-211-1525-000	1/2" x 1"	16	+180°C	50 200	11,17
07-211-2015-000	1/2" x 3/4"	16	+180°C	50 400	6,46
07-211-2025-000	3/4" x 1"	16	+180°C	50 200	10,91
07-211-3225-000	1" x 1 1/4"	16	+180°C	50 150	19,91

GRUPA RABATOWA



5112

Mufa redukcyjna
mosiężna

indeks	wielkość	PN	Tmax	pakowanie		cena netto [zł]
07-212-1510-000	3/8" x 1/2"	16	+180°C	50	500	4,77
07-212-2015-000	1/2" x 3/4"	16	+180°C	50	400	6,82
07-212-2515-000	1/2" x 1"	16	+180°C	50	200	10,96
07-212-2520-000	3/4" x 1"	16	+180°C	50	200	12,08

D GRUPA RABATOWA



5113

Kolano mosiężne



indeks	wielkość	PN	Tmax	pakowanie		cena netto [zł]
07-213-0100-000	3/8"	16	+180°C	60	600	5,29
07-213-0150-000	1/2"	16	+180°C	50	500	8,91
07-213-0200-000	3/4"	16	+180°C	50	200	13,79
07-213-0250-000	1"	16	+180°C	20	120	24,94

D GRUPA RABATOWA



5114

Kolano mosiężne WZ



indeks	wielkość	PN	Tmax	pakowanie		cena netto [zł]
07-214-0100-000	3/8"	16	+180°C	60	600	5,29
07-214-0150-000	1/2"	16	+180°C	10	220	8,98
07-214-0200-000	3/4"	16	+180°C	50	200	14,75
07-214-0250-000	1"	16	+180°C	20	120	26,93

D GRUPA RABATOWA



5115

Kolano mosiężne
redukcyjne WZ

indeks	wielkość	PN	Tmax	pakowanie		cena netto [zł]
07-215-2015-000	3/4" x 1/2"	16	+180°C	10	150	12,42
07-215-2520-000	1" x 3/4"	16	+180°C	10	100	20,16

D GRUPA RABATOWA



5116

Trójnik mosiężny



indeks	wielkość	PN	Tmax	pakowanie		cena netto [zł]
07-216-0150-000	1/2"	16	+180°C	10	180	11,30
07-216-0200-000	3/4"	16	+180°C	10	90	17,89
07-216-0250-000	1"	16	+180°C	5	50	33,05

D GRUPA RABATOWA



07-216-1510-000	1/2" x M10	16	+180°C	50	300	19,83
------------------------	------------	----	--------	----	-----	--------------



5118

Kolano mosiężne
z mocowaniem WW

indeks	wielkość	PN	Tmax	pakowanie		cena netto [zł]
07-218-0150-000	1/2"	16	+180°C	10	150	12,27

D GRUPA RABATOWA



5119

Listwa montażowa
pod baterię

indeks	wielkość	PN	Tmax	pakowanie		cena netto [zł]
07-221-0100-000	15 x 1/2 x 100	16	+110°C	1	60	23,12
07-221-0150-000	15 x 1/2 x 150	16	+110°C	1	20	23,51

D GRUPA RABATOWA



1046

Śrubunek prosty o-ring mosiężny



indeks	wielkość	PN	Tmax	pakowanie		cena netto [zł]
07-146-0100-000	3/8"	16	+120°C	20	200	10,40
07-146-0150-000	1/2"	16	+120°C	18	270	13,32
07-146-0200-000	3/4"	16	+120°C	10	140	21,86
07-146-0250-000	1"	16	+120°C	8	80	40,21
07-146-0320-000	1 1/4"	16	+120°C	10	40	59,17
07-146-0400-000	1 1/2"	16	+120°C	2	20	102,83
07-146-0500-000	2"	16	+120°C	2	20	170,05

B GRUPA RABATOWA

1046S

Śrubunek prosty o-ring mosiężny



indeks	wielkość	PN	Tmax	pakowanie		cena netto [zł]
07-146-0150-002	1/2"	16	+120°C	18	270	13,58
07-146-0200-002	3/4"	16	+120°C	10	120	22,34
07-146-0250-002	1"	16	+120°C	8	80	41,59

B GRUPA RABATOWA

1046A

Śrubunek prosty o-ring z gwintem samouszczel. mosiężny



indeks	wielkość	PN	Tmax	pakowanie		cena netto [zł]
07-146-0150-001	1/2"	16	+120°C	20	200	14,65
07-146-0200-001	3/4"	16	+120°C	18	270	22,85
07-146-0250-001	1"	16	+120°C	10	140	41,61

B GRUPA RABATOWA

Produkt dostępny do wyczerpania zapasów

1047

Śrubunek prosty stożek mosiężny



indeks	wielkość	PN	Tmax	pakowanie		cena netto [zł]
07-147-0100-000	3/8"	16	+120°C	20	200	10,40
07-147-0150-000	1/2"	16	+120°C	18	270	13,32
07-147-0200-000	3/4"	16	+120°C	10	140	21,86
07-147-0250-000	1"	16	+120°C	8	80	40,21
07-147-0320-000	1 1/4"	16	+120°C	10	40	59,17
07-147-0400-000	1 1/2"	16	+120°C	5	25	102,83
07-147-0500-000	2"	16	+120°C	2	12	170,05

B GRUPA RABATOWA

1048

Śrubunek kątowy o-ring mosiężny



indeks	wielkość	PN	Tmax	pakowanie		cena netto [zł]
07-148-0100-000	3/8"	16	+120°C	20	200	11,66
07-148-0150-000	1/2"	16	+120°C	15	150	19,54
07-148-0200-000	3/4"	16	+120°C	10	60	30,22
07-148-0250-000	1"	16	+120°C	10	60	51,93
07-148-0320-000	1 1/4"	16	+120°C	10	40	84,97

B GRUPA RABATOWA

1049

Śrubunek kątowy stożek mosiężny



indeks	wielkość	PN	Tmax	pakowanie		cena netto [zł]
07-149-0150-000	1/2"	16	+120°C	15	180	19,54
07-149-0200-000	3/4"	16	+120°C	10	100	30,22
07-149-0250-000	1"	16	+120°C	10	60	51,93

B GRUPA RABATOWA

5120

Śrubunek wodomierza mosiężny



indeks	wielkość	PN	Tmax	pakowanie		cena netto [zł]
07-190-0150-000	1/2"	16	+90°C	30	150	11,51
07-190-0200-000	3/4"	16	+90°C	20	200	16,20
07-190-0250-000	1"	16	+90°C	10	100	31,84

D GRUPA RABATOWA

5120S

Śrubunek wodomierza mosiężny



indeks	wielkość	PN	Tmax	pakowanie		cena netto [zł]
07-190-0151-000	½" L-36 mm	16	+90°C	2	200	9,61

(D) GRUPA RABATOWA**5122**

Śrubunek prosty z obrotową nakrętką



indeks	wielkość	PN	Tmax	pakowanie		cena netto [zł]
07-150-0150-000	½"	16	+90°C	1	200	9,65
07-150-0200-000	¾"	16	+90°C	1	150	14,16
07-150-0250-000	1"	16	+90°C	5	100	22,63

(B) GRUPA RABATOWA**U51**

Uszczelka płaska fibrowa do śrubunków wodomierza 5120 i 5120S



indeks	wielkość	pakowanie		cena netto [zł]
28-001-0150-000	½"	1	luz	0,33
28-001-0200-000	¾"	1	luz	0,37
28-001-0250-000	1"	1	luz	0,44

(D) GRUPA RABATOWA**5000**

Konsola wodomierza ze stali węglowej z powłoką malarską



indeks	wielkość	PN	Tmax	pakowanie		cena netto [zł]
07-195-0150-000	½"	16	+90°C	1	10	128,36
07-195-0200-000	¾"	16	+90°C	1	10	157,94

(D) GRUPA RABATOWA**5000N**

Konsola wodomierza ze stali nierdzewnej



indeks	wielkość	PN	Tmax	pakowanie		cena netto [zł]
07-195-0150-001	½"	16	+90°C	1	10	166,87
07-195-0200-001	¾"	16	+90°C	1	10	196,43

(D) GRUPA RABATOWA**5000N/A**

Konsola wodomierza ze stali nierdzewnej



indeks	wielkość	PN	Tmax	pakowanie		cena netto [zł]
07-195-0200-002	¾"	16	+90°C	1	10	196,43

(D) GRUPA RABATOWA**U46**

Uszczelka do śrubunków samuszczelniających 1046A



indeks	wielkość	pakowanie		cena netto [zł]
28-000-0150-000	½"	1	luz	0,33
28-000-0200-000	¾"	1	luz	0,35
28-000-0250-000	1"	1	luz	0,58

(B) GRUPA RABATOWA**U60**

Pierścień uszczelniający do śrubunków 1046 i 1046S oraz 1048



indeks	wielkość	pakowanie		cena netto [zł]
28-002-0010-000	¾"	1	luz	0,22
28-002-0150-000	½"	1	luz	0,27
28-002-0200-000	¾"	1	luz	0,31
28-002-0250-000	1"	1	luz	0,33

(B) GRUPA RABATOWA

502

Przedłużka mosiężna chromowana WZ



indeks	wielkość	PN	Tmax	pakowanie	cena netto [zł]
07-521-1510-000	½" x 10	16	+180°C	20 540	5,21
07-521-1515-000	½" x 15	16	+180°C	20 540	6,23
07-521-1520-000	½" x 20	16	+180°C	20 320	7,24
07-521-1525-000	½" x 25	16	+180°C	20 320	8,78
07-521-1530-000	½" x 30	16	+180°C	20 320	10,01
07-521-1540-000	½" x 40	16	+180°C	20 320	12,77
07-521-1550-000	½" x 50	16	+180°C	20 240	15,55
07-521-1560-000	½" x 60	16	+180°C	20 160	18,68
07-521-1580-000	½" x 80	16	+180°C	20 160	24,12
07-521-1599-000	½" x 100	16	+180°C	20 120	30,03
07-521-2010-000	¾" x 10	16	+180°C	20 320	8,40
07-521-2020-000	¾" x 20	16	+180°C	20 320	12,75
07-521-2030-000	¾" x 30	16	+180°C	20 320	16,95
07-521-2040-000	¾" x 40	16	+180°C	20 180	21,32
07-521-2050-000	¾" x 50	16	+180°C	20 180	24,90

D

GRUPA RABATOWA

520

Nypel mosiężny chromowany



indeks	wielkość	PN	Tmax	pakowanie	cena netto [zł]
07-520-0100-000	¾"	16	+180°C	20 1000	3,44
07-520-0150-000	½"	16	+180°C	20 1000	5,08
07-520-0200-000	¾"	16	+180°C	20 240	7,89

D

GRUPA RABATOWA

454

Mufa mosiężna chromowana



indeks	wielkość	PN	Tmax	pakowanie	cena netto [zł]
07-454-0100-000	¾"	16	+180°C	20 600	6,35
07-454-0150-000	½"	16	+180°C	20 240	7,66
07-454-0200-000	¾"	16	+180°C	20 240	11,73

D

GRUPA RABATOWA

511

Redukcja mosiężna chromowana



indeks	wielkość	PN	Tmax	pakowanie	cena netto [zł]
07-511-1015-000	¾" x ½"	16	+180°C	20 1000	2,98
07-511-1520-000	½" x ¾"	16	+180°C	20 600	5,26

D

GRUPA RABATOWA

512

Redukcja mosiężna chromowana z uszczelką



indeks	wielkość	PN	Tmax	pakowanie	cena netto [zł]
07-512-1015-000	¾" x ½"	16	+180°C	50 800	4,22

D

GRUPA RABATOWA

515

Nypel redukcyjny mosiężny chromowany



indeks	wielkość	PN	Tmax	pakowanie	cena netto [zł]
07-515-1015-000	¾" x ½"	16	+180°C	20 320	4,41
07-515-1520-000	½" x ¾"	16	+180°C	20 240	7,36

D

GRUPA RABATOWA

506

Redukcja mufowo-nypłowa mosiężna chromowana



indeks	wielkość	PN	Tmax	pakowanie	cena netto [zł]
07-506-1015-000	¾" x ½"	16	+180°C	20 800	5,48
07-506-1520-000	½" x ¾"	16	+180°C	20 480	8,50

D

GRUPA RABATOWA

510Redukcja mufowa
mosiężna chromowana

indeks	wielkość	PN	Tmax	pakowanie	cena netto [zł]
07-510-1015-000	3/8" x 1/2"	16	+180°C	20 280	6,59
07-510-1520-000	1/2" x 3/4"	16	+180°C	20 480	9,61

D GRUPA RABATOWA**451**Kolano mosiężne
chromowane WZ

indeks	wielkość	PN	Tmax	pakowanie	cena netto [zł]
07-451-0100-000	3/8"	16	+180°C	20 320	8,09
07-451-0150-000	1/2"	16	+180°C	20 360	10,83
07-451-0200-000	3/4"	16	+180°C	20 200	17,86

D GRUPA RABATOWA**452**Kolano mosiężne
chromowane WW

indeks	wielkość	PN	Tmax	pakowanie	cena netto [zł]
07-452-0100-000	3/8"	16	+180°C	20 360	8,13
07-452-0150-000	1/2"	16	+180°C	20 480	10,35
07-452-0200-000	3/4"	16	+180°C	20 240	17,69

D GRUPA RABATOWA**453**Trójnik mosiężny
chromowany

indeks	wielkość	PN	Tmax	pakowanie	cena netto [zł]
07-453-0100-000	3/8"	16	+180°C	20 480	8,68
07-453-0150-000	1/2"	16	+180°C	20 480	12,38
07-453-0200-000	3/4"	16	+180°C	20 280	18,92

D GRUPA RABATOWA**453WWZ**Trójnik mosiężny
chromowany WWZ

indeks	wielkość	PN	Tmax	pakowanie	cena netto [zł]
07-453-0150-001	1/2"	16	+180°C	20 480	17,78

D GRUPA RABATOWA**1046CH**Śrubunek prosty o-ring
mosiężny chromowany

indeks	wielkość	PN	Tmax	pakowanie	cena netto [zł]
07-450-0100-000	3/8"	16	+120°C	20 200	11,40
07-450-0150-000	1/2"	16	+120°C	18 280	15,03

D GRUPA RABATOWA**1048CH**Śrubunek kątowy o-ring
mosiężny chromowany

indeks	wielkość	PN	Tmax	pakowanie	cena netto [zł]
07-449-0150-000	1/2"	16	+120°C	18 180	15,24
07-449-0200-000	3/4"	16	+120°C	10 100	24,58

D GRUPA RABATOWA**5101CH**Korek mosiężny
chromowany GZ

indeks	wielkość	PN	Tmax	pakowanie	cena netto [zł]
07-456-0150-000	1/2"	16	+180°C	50 1000	3,94
07-456-0200-000	3/4"	16	+180°C	50 500	6,32

D GRUPA RABATOWA

5102CH

Zaślepka mosiężna chromowana



indeks	wielkość	PN	Tmax	pakowanie		cena netto [zł]
07-457-0150-000	1/2"	16	+180°C	50	800	4,30
07-457-0200-000	3/4"	16	+180°C	130	520	6,18

(D) GRUPA RABATOWA**PHA-351**

Przedłużka pod baterię ścienną mosiężna chromowana WZ



indeks	wielkość	PN	Tmax	pakowanie		cena netto [zł]
07-351-0200-000	3/4"	16	+180°C	20	180	17,71

(D) GRUPA RABATOWA**PHA-352**

Trójnik typu "Y" mosiężny chromowany WZ



indeks	wielkość	PN	Tmax	pakowanie		cena netto [zł]
07-352-0150-000	1/2"	16	+180°C	20	200	20,44

(D) GRUPA RABATOWA**TT**

Taśma teflonowa



indeks	wielkość	kolor taśmy	pakowanie		cena netto [zł]
29-002-0000-000	0,2 mm x 12 mm x 15 mb	niebieska	5	50	11,42
29-003-0000-000	0,2 mm x 19 mm x 15 mb	żółta	5	50	10,37
29-004-0000-000	0,2 mm x 25 mm x 15 mb	czerwona	5	50	13,90
29-001-0002-000	0,075 mm x 12mm x 10 mb	biała	10	250	1,85

(E) GRUPA RABATOWA**PHA-011**

Kurek kulowy z filtrem podłączeniowy, metalowe pokrętko



indeks	wielkość	PN	Tmax	pakowanie		cena netto [zł]
02-011-1510-000	1/2" x 3/8"	16	+120°C	1	100	26,43
02-011-1515-000	1/2" x 1/2"	16	+120°C	1	100	26,79
02-011-1520-000	1/2" x 3/4"	16	+120°C	1	100	28,25

(K) GRUPA RABATOWA**PHA-012**

Kurek kulowy z filtrem podłączeniowy krótki, metalowe pokrętko



indeks	wielkość	PN	Tmax	pakowanie		cena netto [zł]
02-012-1510-000	1/2" x 3/8"	16	+120°C	1	100	23,71
02-012-1515-000	1/2" x 1/2"	16	+120°C	1	100	24,09
02-012-1520-000	1/2" x 3/4"	16	+120°C	1	100	25,69

(K) GRUPA RABATOWA**PHA-0140**

Prolunga zawór grzybkowy podłączeniowy z obrotową nakrętką i przedłużką



indeks	wielkość	PN	Tmax	pakowanie		cena netto [zł]
02-014-0200-001	3/4" x 3/4" x 3/4"	10	+90°C	1	150	51,85

(E) GRUPA RABATOWA**PHA-018**

Zawór grzybkowy podłączeniowy



indeks	wielkość	PN	Tmax	pakowanie		cena netto [zł]
02-018-1510-000	1/2" x 3/8"	16	+120°C	20	200	22,02
02-018-1515-000	1/2" x 1/2"	16	+120°C	20	200	22,33
02-018-1520-000	1/2" x 3/4"	16	+120°C	20	200	23,38

(K) GRUPA RABATOWA

PHA-050Zawór kombinowany
podłączeniowyPERFEKT^{SYSTEM}

indeks	wielkość	PN	Tmax	pakowanie		cena netto [zł]
02-050-1520-000	1/2" x 3/8" x 3/4"	10	+90°C	1	80	54,54

(K) GRUPA RABATOWA**PHA-051**Zawór podłączeniowy
kątowy z ceramiczną
głowicąPERFEKT^{SYSTEM}

indeks	wielkość	PN	Tmax	pakowanie		cena netto [zł]
02-051-1510-000	1/2" x 3/8"	10	+90°C	1	100	33,14
02-051-1515-000	1/2" x 1/2"	10	+90°C	1	100	33,43
02-051-1520-000	1/2" x 3/4"	10	+90°C	1	100	34,42

(K) GRUPA RABATOWA**PHA-052**Zawór podłączeniowy
kątowy z ceramiczną
głowicąPERFEKT^{SYSTEM}

indeks	wielkość	PN	Tmax	pakowanie		cena netto [zł]
02-052-1510-000	1/2" x 3/8"	10	+90°C	1	100	30,59
02-052-1515-000	1/2" x 1/2"	10	+90°C	1	100	31,22
02-052-1520-000	1/2" x 3/4"	10	+90°C	1	100	32,76

(K) GRUPA RABATOWA**PHA-055**Zawór kulowy antykamieny
podłączeniowy,
metalowe pokrętłoPERFEKT^{SYSTEM}

indeks	wielkość	PN	Tmax	pakowanie		cena netto [zł]
02-055-1510-000	1/2" x 3/8"	10	+90°C	1	100	22,64
02-055-1515-000	1/2" x 1/2"	10	+90°C	1	100	23,08
02-055-1520-000	1/2" x 3/4"	10	+90°C	1	100	23,32

(K) GRUPA RABATOWA**PHA-056**Zawór grzybkowy z filtrem
podłączeniowyPERFEKT^{SYSTEM}

indeks	wielkość	PN	Tmax	pakowanie		cena netto [zł]
02-056-1510-000	1/2" x 3/8"	10	+90°C	1	100	20,58
02-056-1515-000	1/2" x 1/2"	10	+90°C	1	100	20,87

(K) GRUPA RABATOWA**3003**Zawór kulowy
podłączeniowy

indeks	wielkość	PN	Tmax	pakowanie		cena netto [zł]
02-200-1510-000	1/2" x 3/8"	16	+120°C	1	100	15,90
02-200-1515-000	1/2" x 1/2"	16	+120°C	1	100	16,39
02-200-1520-000	1/2" x 3/4"	16	+120°C	1	100	16,89

(B) GRUPA RABATOWA**3003S**Zawór kulowy
podłączeniowy krótki

indeks	wielkość	PN	Tmax	pakowanie		cena netto [zł]
02-204-1510-000	1/2" x 3/8"	10	+90°C	25	100	14,49

(B) GRUPA RABATOWA**3026**Kurek kulowy trójdrogowy
podłączeniowy

indeks	wielkość	PN	Tmax	pakowanie		cena netto [zł]
02-302-1515-000	1/2" x 1/2" x 3/4"	10	+90°C	1	200	23,75

(E) GRUPA RABATOWA

PHA-9105

Przyłącze elastyczne w oplocie ze stali nierdzewnej WZ

E GRUPA RABATOWA

PERFEKT² SYSTEM

indeks	wielkość	DN	PN	Tmax	pakowanie	cena netto [zł]
06-000-1010-030	3/8" x 3/8" x 30	8	10	+70°C	10 200	11,32
06-000-1010-040	3/8" x 3/8" x 40	8	10	+70°C	10 150	11,70
06-000-1010-050	3/8" x 3/8" x 50	8	10	+70°C	10 100	12,62
06-000-1515-020	1/2" x 1/2" x 20	8	10	+70°C	10 200	11,15
06-000-1515-025	1/2" x 1/2" x 25	8	10	+70°C	10 260	11,52
06-000-1515-030	1/2" x 1/2" x 30	8	10	+70°C	10 200	11,98
06-000-1515-040	1/2" x 1/2" x 40	8	10	+70°C	10 150	12,99
06-000-1515-045	1/2" x 1/2" x 45	8	10	+70°C	10 150	13,52
06-000-1515-050	1/2" x 1/2" x 50	8	10	+70°C	10 150	14,10
06-000-1515-060	1/2" x 1/2" x 60	8	10	+70°C	10 100	15,10
06-000-1515-070	1/2" x 1/2" x 70	8	10	+70°C	10 100	16,89
06-000-1515-080	1/2" x 1/2" x 80	8	10	+70°C	10 100	17,75
06-000-1515-090	1/2" x 1/2" x 90	8	10	+70°C	10 90	19,55
06-000-1515-100	1/2" x 1/2" x 100	8	10	+70°C	10 100	20,66
06-000-1515-120	1/2" x 1/2" x 120	8	10	+70°C	10 70	21,92
06-000-1515-150	1/2" x 1/2" x 150	8	10	+70°C	10 50	24,85

PHA-9110

Przyłącze elastyczne w oplocie ze stali nierdzewnej WW

E GRUPA RABATOWA

PERFEKT² SYSTEM

indeks	wielkość	DN	PN	Tmax	pakowanie	cena netto [zł]
06-001-1010-020	3/8" x 3/8" x 20	8	10	+70°C	10 200	10,14
06-001-1010-030	3/8" x 3/8" x 30	8	10	+70°C	10 200	10,96
06-001-1010-040	3/8" x 3/8" x 40	8	10	+70°C	10 150	12,14
06-001-1010-050	3/8" x 3/8" x 50	8	10	+70°C	10 150	13,17
06-001-1010-060	3/8" x 3/8" x 60	8	10	+70°C	10 100	14,43
06-001-1510-020	1/2" x 3/8" x 20	8	10	+70°C	10 200	10,87
06-001-1510-030	1/2" x 3/8" x 30	8	10	+70°C	10 200	11,52
06-001-1510-040	1/2" x 3/8" x 40	8	10	+70°C	10 150	12,81
06-001-1510-050	1/2" x 3/8" x 50	8	10	+70°C	10 150	14,10
06-001-1510-060	1/2" x 3/8" x 60	8	10	+70°C	10 100	14,98
06-001-1515-020	1/2" x 1/2" x 20	8	10	+70°C	10 200	10,58
06-001-1515-025	1/2" x 1/2" x 25	8	10	+70°C	10 200	11,15
06-001-1515-030	1/2" x 1/2" x 30	8	10	+70°C	10 200	11,90
06-001-1515-035	1/2" x 1/2" x 35	8	10	+70°C	10 200	12,43
06-001-1515-040	1/2" x 1/2" x 40	8	10	+70°C	10 150	12,81
06-001-1515-045	1/2" x 1/2" x 45	8	10	+70°C	10 150	13,24
06-001-1515-050	1/2" x 1/2" x 50	8	10	+70°C	10 150	13,72
06-001-1515-055	1/2" x 1/2" x 55	8	10	+70°C	10 140	14,16
06-001-1515-060	1/2" x 1/2" x 60	8	10	+70°C	10 100	14,62
06-001-1515-070	1/2" x 1/2" x 70	8	10	+70°C	10 100	16,08
06-001-1515-080	1/2" x 1/2" x 80	8	10	+70°C	10 100	16,65
06-001-1515-090	1/2" x 1/2" x 90	8	10	+70°C	10 100	18,29
06-001-1515-100	1/2" x 1/2" x 100	8	10	+70°C	10 80	19,47
06-001-1515-120	1/2" x 1/2" x 120	8	10	+70°C	10 50	21,55
06-001-1515-150	1/2" x 1/2" x 150	8	10	+70°C	10 50	25,58

PHA-9125

Przyłącze elastyczne w oplocie ze stali nierdzewnej WW

E GRUPA RABATOWA

PERFEKT² SYSTEM

indeks	wielkość	DN	PN	Tmax	pakowanie	cena netto [zł]
06-002-1520-030	1/2" x 3/4" x 30	8	10	+70°C	10 270	14,55
06-002-1520-040	1/2" x 3/4" x 40	8	10	+70°C	10 160	15,77
06-002-1520-050	1/2" x 3/4" x 50	8	10	+70°C	10 140	17,55
06-002-2020-030	3/4" x 3/4" x 30	8	10	+70°C	10 220	22,81
06-002-2020-040	3/4" x 3/4" x 40	8	10	+70°C	10 160	24,91
06-002-2020-050	3/4" x 3/4" x 50	8	10	+70°C	10 140	28,12

PHA-9126Przyłącze elastyczne z kolankiem
w oplocie ze stali nierdzewnej WW**E** GRUPA RABATOWA**PERFEKT²SYSTEM**

indeks	wielkość	DN	PN	Tmax	pakowanie		cena netto [zł]
06-005-1515-040	½" x ½" x 40	8	10	+70°C	1	120	30,61
06-005-1515-050	½" x ½" x 50	8	10	+70°C	1	100	32,68
06-005-1515-060	½" x ½" x 60	8	10	+70°C	1	100	34,74
06-005-1515-080	½" x ½" x 80	8	10	+70°C	1	70	38,90
06-005-1515-100	½" x ½" x 100	8	10	+70°C	1	60	42,88
06-005-1515-120	½" x ½" x 120	8	10	+70°C	1	50	47,02
06-005-1515-150	½" x ½" x 150	8	10	+70°C	1	40	51,16

PHA-9145/CPrzyłącze elastyczne do baterii
w oplocie ze stali nierdzewnej, krótkie**E** GRUPA RABATOWA**PERFEKT²SYSTEM**

indeks	wielkość	DN	PN	Tmax	pakowanie		cena netto [zł]
06-003-1010-030	M10x1 x ¾" x 30	8	10	+70°C	10	200	10,24
06-003-1010-040	M10x1 x ¾" x 40	8	10	+70°C	10	150	11,08
06-003-1010-050	M10x1 x ¾" x 50	8	10	+70°C	10	240	12,08
06-003-1010-060	M10x1 x ¾" x 60	8	10	+70°C	10	100	13,08
06-003-1010-080	M10x1 x ¾" x 80	8	10	+70°C	10	100	13,74
06-003-1510-030	M10x1 x ½" x 30	8	10	+70°C	10	300	10,33
06-003-1510-035	M10x1 x ½" x 35	8	10	+70°C	10	150	10,87
06-003-1510-040	M10x1 x ½" x 40	8	10	+70°C	10	150	11,41
06-003-1510-050	M10x1 x ½" x 50	8	10	+70°C	10	100	12,47
06-003-1510-060	M10x1 x ½" x 60	8	10	+70°C	10	100	13,59
06-003-1510-070	M10x1 x ½" x 70	8	10	+70°C	10	200	14,64
06-003-1510-080	M10x1 x ½" x 80	8	10	+70°C	10	130	15,75

PHA-9155 wąż antywibracyjnyPrzyłącze w oplocie ze stali
nierdzewnej WW**K** GRUPA RABATOWA**PERFEKT²SYSTEM**

indeks	wielkość	DN	PN	Tmax	pakowanie		cena netto [zł]
06-011-0150-030	½" x 30	13	12	+110°C	1	1	30,74
06-011-0150-040	½" x 40	13	12	+110°C	1	1	33,15
06-011-0150-050	½" x 50	13	12	+110°C	1	1	35,58
06-011-0150-060	½" x 60	13	12	+110°C	1	1	37,96
06-011-0200-030	¾" x 30	18	12	+110°C	1	1	50,93
06-011-0200-040	¾" x 40	18	12	+110°C	1	1	54,80
06-011-0200-050	¾" x 50	18	12	+110°C	1	1	58,64
06-011-0200-060	¾" x 60	18	12	+110°C	1	1	62,52
06-011-0200-070	¾" x 70	18	12	+110°C	1	1	66,40
06-011-0200-080	¾" x 80	18	12	+110°C	1	1	70,25
06-011-0200-090	¾" x 90	18	12	+110°C	1	1	74,13
06-011-0200-100	¾" x 100	18	12	+110°C	1	1	77,98
06-011-0200-120	¾" x 120	18	12	+110°C	1	1	85,65
06-011-0200-150	¾" x 150	18	12	+110°C	1	1	97,27
06-011-0250-030	1" x 30	25	10	+110°C	1	1	69,49
06-011-0250-040	1" x 40	25	10	+110°C	1	1	74,09
06-011-0250-050	1" x 50	25	10	+110°C	1	1	78,59
06-011-0250-060	1" x 60	25	10	+110°C	1	1	83,16
06-011-0250-070	1" x 70	25	10	+110°C	1	1	87,76
06-011-0250-080	1" x 80	25	10	+110°C	1	1	92,31
06-011-0250-090	1" x 90	25	10	+110°C	1	1	96,82
06-011-0250-100	1" x 100	25	10	+110°C	1	1	101,40
06-011-0250-120	1" x 120	25	10	+110°C	1	1	116,97
06-011-0250-150	1" x 150	25	10	+110°C	1	1	131,46
06-011-0320-030	1¼" x 30	32	10	+110°C	1	1	236,59
06-011-0320-040	1¼" x 40	32	10	+110°C	1	1	259,02
06-011-0320-050	1¼" x 50	32	10	+110°C	1	1	281,45
06-011-0320-060	1¼" x 60	32	10	+110°C	1	1	303,83
06-011-0320-070	1¼" x 70	32	10	+110°C	1	1	326,25
06-011-0320-080	1¼" x 80	32	10	+110°C	1	1	348,67

PHA-9150 wąż antywibracyjny

Przyłącze elastyczne w oplocie ze stali nierdzewnej WZ

(K) GRUPA RABATOWA**PERFEKT² SYSTEM**

indeks	wielkość	DN	PN	Tmax	pakowanie	cena netto [zł]
06-010-0150-030	½" x 30	13	12	+110°C	1 1	32,15
06-010-0150-040	½" x 40	13	12	+110°C	1 1	34,80
06-010-0150-050	½" x 50	13	12	+110°C	1 1	37,32
06-010-0150-060	½" x 60	13	12	+110°C	1 1	39,83
06-010-0200-030	¾" x 30	18	12	+110°C	1 1	53,48
06-010-0200-040	¾" x 40	18	12	+110°C	1 1	57,54
06-010-0200-050	¾" x 50	18	12	+110°C	1 1	61,58
06-010-0200-060	¾" x 60	18	12	+110°C	1 1	65,66
06-010-0200-070	¾" x 70	18	12	+110°C	1 1	69,72
06-010-0200-080	¾" x 80	18	12	+110°C	1 1	73,76
06-010-0200-090	¾" x 90	18	12	+110°C	1 1	77,83
06-010-0200-100	¾" x 100	18	12	+110°C	1 1	81,87
06-010-0200-120	¾" x 120	18	12	+110°C	1 1	90,00
06-010-0200-150	¾" x 150	18	12	+110°C	1 1	102,18
06-010-0250-030	1" x 30	25	10	+110°C	1 1	73,00
06-010-0250-040	1" x 40	25	10	+110°C	1 1	77,81
06-010-0250-050	1" x 50	25	10	+110°C	1 1	82,52
06-010-0250-060	1" x 60	25	10	+110°C	1 1	87,33
06-010-0250-070	1" x 70	25	10	+110°C	1 1	92,15
06-010-0250-080	1" x 80	25	10	+110°C	1 1	96,93
06-010-0250-090	1" x 90	25	10	+110°C	1 1	101,65
06-010-0250-100	1" x 100	25	10	+110°C	1 1	106,46
06-010-0250-120	1" x 120	25	10	+110°C	1 1	122,84
06-010-0250-150	1" x 150	25	10	+110°C	1 1	138,01
06-010-0320-030	1¼" x 30	32	10	+110°C	1 1	248,45
06-010-0320-040	1¼" x 40	32	10	+110°C	1 1	272,00
06-010-0320-050	1¼" x 50	32	10	+110°C	1 1	295,51
06-010-0320-060	1¼" x 60	32	10	+110°C	1 1	319,02
06-010-0320-070	1¼" x 70	32	10	+110°C	1 1	342,58
06-010-0320-080	1¼" x 80	32	10	+110°C	1 1	366,10

PHA-9156 wąż antywibracyjny

Przyłącze w oplocie ze stali nierdzewnej z kolankiem WZ

(K) GRUPA RABATOWA**PERFEKT² SYSTEM**

indeks	wielkość	DN	PN	Tmax	pakowanie	cena netto [zł]
06-012-0250-040	1" x 40	25	10	+110°C	1 1	77,02
06-012-0250-050	1" x 50	25	10	+110°C	1 1	81,66
06-012-0250-060	1" x 60	25	10	+110°C	1 1	86,38
06-012-0250-070	1" x 70	25	10	+110°C	1 1	91,08
06-012-0250-080	1" x 80	25	10	+110°C	1 1	95,70
06-012-0250-090	1" x 90	25	10	+110°C	1 1	100,41
06-012-0250-100	1" x 100	25	10	+110°C	1 1	105,11
06-012-0250-120	1" x 120	25	10	+110°C	1 1	114,47
06-012-0250-150	1" x 150	25	10	+110°C	1 1	128,52

PHA-9145/L

Przyłącze elastyczne do baterii w oplocie ze stali nierdzewnej, długie

(E) GRUPA RABATOWA**PERFEKT² SYSTEM**

indeks	wielkość	DN	PN	Tmax	pakowanie	cena netto [zł]
06-004-1010-030	M10x1 x ¾" x 30	8	10	+70°C	10 200	11,15
06-004-1010-040	M10x1 x ¾" x 40	8	10	+70°C	10 150	12,18
06-004-1010-050	M10x1 x ¾" x 50	8	10	+70°C	10 150	13,21
06-004-1010-060	M10x1 x ¾" x 60	8	10	+70°C	10 100	14,22
06-004-1010-080	M10x1 x ¾" x 80	8	10	+70°C	10 100	16,22
06-004-1510-030	M10x1 x ½" x 30	8	10	+70°C	10 200	11,63
06-004-1510-040	M10x1 x ½" x 40	8	10	+70°C	10 150	12,74
06-004-1510-050	M10x1 x ½" x 50	8	10	+70°C	10 150	13,80
06-004-1510-060	M10x1 x ½" x 60	8	10	+70°C	10 100	14,91
06-004-1510-070	M10x1 x ½" x 70	8	10	+70°C	10 100	16,00
06-004-1510-080	M10x1 x ½" x 80	8	10	+70°C	10 100	17,09



PERFEXIM

CENNIK ARMATURA 2024



Produkty spełniające surowe wymagania wyrobów przeznaczonych do instalacji gazowych

PERFEKT² SYSTEM

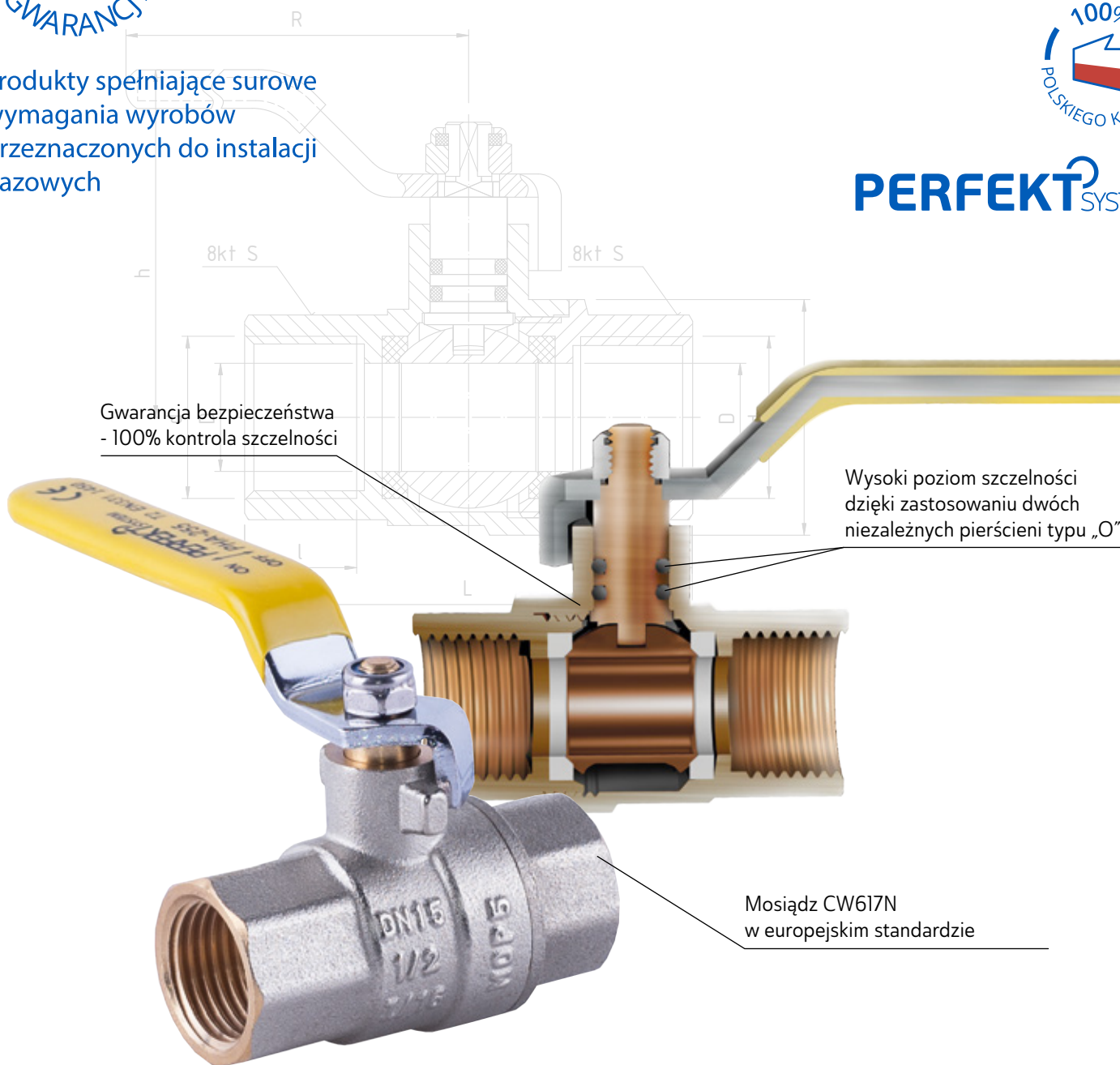

Gwarancja bezpieczeństwa
- 100% kontrola szczelności

Wysoki poziom szczelności
dzięki zastosowaniu dwóch
niezależnych pierścieni typu „O”

Mosiądz CW617N
w europejskim standardzie

ARMATURA GAZOWA

32

Kurki kulowe	33
Filtry	33
Przyłącza	33

PHA-255

PERFEKT SYSTEM

Kurek kulowy do gazu WW,
MOP5 T2

C GRUPA RABATOWA

PERFEKT^{SYSTEM}

indeks	wielkość	pakowanie		cena netto [zł]
10-255-0150-000	½"	16	144	29,46
10-255-0200-000	¾"	10	90	46,91
10-255-0250-000	1"	8	64	74,00
10-255-0320-000	1¼"	4	32	121,49
10-255-0400-000	1½"	2	18	166,80
10-255-0500-000	2"	2	16	284,18



PHA-260

PERFEKT SYSTEM

Filtr skośny do gazu,
MOP5 T2

C GRUPA RABATOWA

PERFEKT^{SYSTEM}

indeks	wielkość	pakowanie		cena netto [zł]
10-260-0150-000	½"	12	168	27,04
10-260-0200-000	¾"	8	96	44,53
10-260-0250-000	1"	7	63	59,98
10-260-0320-000	1¼"	4	32	119,21
10-260-0400-000	1½"	2	18	150,23
10-260-0500-000	2"	2	16	240,32



PHA-250/2

PERFEKT SYSTEM

Bezpieczny metalowy
przewód przyłączeniowy
WW Typ 1

K GRUPA RABATOWA

PERFEKT^{SYSTEM}

indeks	rozmiar	pakowanie		cena netto [zł]
11-016-0500-000	500	1	200	63,73
11-016-0750-000	750	1	200	68,32
11-016-1000-000	1000	1	175	71,49
11-016-1250-000	1250	1	150	83,45
11-016-1500-000	1500	1	125	94,61
11-016-2000-000	2000	1	100	113,00



PHA-251/2

PERFEKT SYSTEM

Bezpieczny metalowy
przewód przyłączeniowy
WZ do gazu Typ1

K GRUPA RABATOWA

PERFEKT^{SYSTEM}

indeks	rozmiar	pakowanie		cena netto [zł]
11-017-0500-000	500	1	200	63,73
11-017-0750-000	750	1	200	68,32
11-017-1000-000	1000	1	175	71,49
11-017-1250-000	1250	1	150	83,45
11-017-1500-000	1500	1	125	94,61
11-017-2000-000	2000	1	100	113,00



Przewód rozciągliwy

Przewód rozciągliwy
do gazu WZ

K GRUPA RABATOWA

indeks	rozmiar	zakres długości	PN	DN	Tmax	pakowanie		cena netto [zł]
11-012-0130-000	½" x ½"	130-220mm	5	16	+120°C	1	50	40,57
11-012-0220-000	½" x ½"	220-420mm	5	16	+120°C	1	40	47,34
11-012-0300-000	½" x ½"	300-600mm	5	16	+120°C	1	50	58,15
11-012-0500-000	½" x ½"	500-1000mm	5	16	+120°C	1	40	75,72
11-012-0750-000	½" x ½"	750-1500mm	5	16	+120°C	1	50	87,89
11-013-0130-000	¾" x ¾"	130-220mm	5	20	+120°C	1	50	63,55
11-013-0220-000	¾" x ¾"	220-420mm	5	20	+120°C	1	50	74,37
11-013-0300-000	¾" x ¾"	300-600mm	5	20	+120°C	1	40	87,89
11-013-0500-000	¾" x ¾"	500-1000mm	5	20	+120°C	1	30	112,23
11-013-0750-000	¾" x ¾"	750-1500mm	5	20	+120°C	1	30	120,35
11-013-1000-000	¾" x ¾"	1000-2000mm	5	20	+120°C	1	30	129,82



Profesjonalne
rozdzielenie ciepła

PERFEXIM

CENNIK ARMATURA 2024



93.5

PERFEKT² SYSTEM

Ochrona zdrowotna i antyalergiczna
- brak niklu na powierzchniach
mających kontakt z wodą pitną

Ułatwienie prac instalatorskich
przez różne konfiguracje
spełniające oczekiwania

Stal nierdzewna gatunku 1.4301
o europejskim standardzie

ARMATURA CENTRALNEGO OGRZEWANIA

34-54

System antyzamroziowy	35
Komplety / głowice termostatyczne	35
Zawory grzejnikowe	39
Zawory bezpieczeństwa	42
Pompy obiegowe	43
Rozdzielacze, osprzęt rozdzielaczy	44
Zawory odpowietrzające	53
Automatyka ogrzewania	54
Uchwyty do bojlerów	54

PHA-SAZ/2

System antyzamrożeniowy do pomp ciepła typu monoblok

**PERFEKT²SYSTEM**

indeks	pakowanie		cena netto [zł]
58-000-0000-000	1	1	1900,00
58-000-0000-100	1	1	2100,00

(K) GRUPA RABATOWA

PHA-024

Komplet termostatyczny prosty

**PERFEKT²SYSTEM**

indeks	wielkość	PN	kolor	Tmax	pakowanie		cena netto [zł]
20-024-0000-000	½"	10	chrom	+120°C	1	30	107,61

(K) GRUPA RABATOWA

PHA-024W

Komplet termostatyczny prosty

**PERFEKT²SYSTEM**

indeks	wielkość	PN	kolor	Tmax	pakowanie		cena netto [zł]
20-024-0000-001	½"	10	biały	+120°C	1	30	118,25

(K) GRUPA RABATOWA

PHA-025

Komplet termostatyczny kątowy

**PERFEKT²SYSTEM**

indeks	wielkość	PN	kolor	Tmax	pakowanie		cena netto [zł]
20-025-0000-000	½"	10	chrom	+120°C	1	30	113,00

(K) GRUPA RABATOWA

PHA-025W

Komplet termostatyczny kątowy

**PERFEKT²SYSTEM**

indeks	wielkość	PN	kolor	Tmax	pakowanie		cena netto [zł]
20-025-0000-001	½"	10	biały	+120°C	1	30	118,25

(K) GRUPA RABATOWA

PHA-026

Komplet termostatyczny z nastawą wstępną, prosty

**PERFEKT²SYSTEM**

indeks	wielkość	PN	Tmax	pakowanie		cena netto [zł]
20-026-0000-000	½"	10	+120°C	1	1	109,08

(K) GRUPA RABATOWA

PHA-027

Komplet termostatyczny z nastawą wstępną, kątowy

**PERFEKT²SYSTEM**

indeks	wielkość	PN	Tmax	pakowanie		cena netto [zł]
20-027-0000-000	½"	10	+120°C	1	1	109,08

(K) GRUPA RABATOWA

PHA-036

Zintegrowany zestaw termostatyczny z nastawą wstępną, kątowy



(K) GRUPA RABATOWA



chromowany



biały



grafit



czarny mat



czarny struktura

PERFEKT^{SYSTEM}

indeks	wielkość	PN	kolor	Tmax	pakowanie		cena netto [zł]
20-036-0000-000	½"	10	chrom	+120°C	1	20	202,15
20-036-0000-001	½"	10	biały	+120°C	1	20	207,20
20-036-0000-002	½"	10	grafit	+120°C	1	20	224,89
20-036-0000-003	½"	10	czarny mat	+120°C	1	20	224,89
20-036-0000-004	½"	10	czarny struktura	+120°C	1	20	224,89

PHA-037

Komplet termostatyczny z nastawą wstępną "lewy"



(K) GRUPA RABATOWA



chromowany



biały



grafit



czarny mat



czarny struktura

PERFEKT^{SYSTEM}

indeks	wielkość	PN	kolor	Tmax	pakowanie		cena netto [zł]
20-037-0000-000	½"	10	chrom	+120°C	1	20	199,62
20-037-0000-001	½"	10	biały	+120°C	1	20	202,15
20-037-0000-002	½"	10	grafit	+120°C	1	20	214,79
20-037-0000-003	½"	10	czarny mat	+120°C	1	20	214,79
20-037-0000-004	½"	10	czarny struktura	+120°C	1	20	214,79

PHA-038

Komplet termostatyczny z nastawą wstępną "prawy"



(K) GRUPA RABATOWA



chromowany



biały



grafit



czarny mat



czarny struktura

PERFEKT^{SYSTEM}

indeks	wielkość	PN	kolor	Tmax	pakowanie		cena netto [zł]
20-038-0000-000	½"	10	chrom	+120°C	1	20	199,62
20-038-0000-001	½"	10	biały	+120°C	1	20	202,15
20-038-0000-002	½"	10	grafit	+120°C	1	20	214,79
20-038-0000-003	½"	10	czarny mat	+120°C	1	20	214,79
20-038-0000-004	½"	10	czarny struktura	+120°C	1	20	214,79

7024

Komplet termostatyczny prosty z głowicą z blokadą nastawy



(E) GRUPA RABATOWA

indeks	PN	Tmax	pakowanie		cena netto [zł]
20-107-0200-000	10	+120°C	1	40	94,74

7025

Komplet termostatyczny kątowy z głowicą z blokadą nastawy



(E) GRUPA RABATOWA

indeks	PN	Tmax	pakowanie		cena netto [zł]
20-107-0200-010	10	+120°C	1	40	94,74

7030

Komplet kątowy do podłączenia grzejnika, chromowany



(E) GRUPA RABATOWA

indeks	wielkość	PN	Tmax	pakowanie		cena netto [zł]
20-108-0100-000	½"	10	+120°C	1	55	100,15

7031

Komplet kątowy do podłączenia grzejnika, biały, wypukłe pokrętko



indeks	wielkość	PN	Tmax	pakowanie	cena netto [zł]
20-108-0100-001	½"	10	+120°C	1 55	100,15

E GRUPA RABATOWA

7032

Komplet kątowy do podłączenia grzejnika, wypukłe pokrętko



indeks	wielkość	PN	kolor	Tmax	pakowanie	cena netto [zł]
20-108-0100-002	½"	10	grafit	+120°C	1 55	103,53
20-108-0100-003	½"	10	czarny mat	+120°C	1 55	103,53
20-108-0100-004	½"	10	czarny struktura	+120°C	1 55	103,53

E GRUPA RABATOWA

ZM02

Zestaw maskujący do grzejników z dwiema rozetami okrągłymi i tulejami

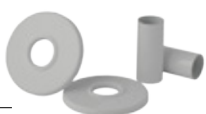

indeks	kolor	pakowanie	cena netto [zł]
20-040-1000-200	chrom	1 48	38,85
20-040-1000-201	biały	1 48	38,85
20-040-1000-203	czarny mat	1 48	38,85

K GRUPA RABATOWA



chrom



biały



czarny mat

ZMK2

Zestaw maskujący do grzejników z dwiema rozetami kwadratowymi i tulejami



indeks	kolor	pakowanie	cena netto [zł]
20-040-1020-200	chrom	1 48	57,75
20-040-1020-201	biały	1 48	57,75
20-040-1020-203	czarny mat	1 48	57,75

K GRUPA RABATOWA



chrom



biały



czarny mat

ZM01

Zestaw maskujący do grzejników z rozetą owalną i tulejami



indeks	kolor	pakowanie	cena netto [zł]
20-040-1040-100	chrom	1 48	38,85
20-040-1040-101	biały	1 48	38,85
20-040-1040-103	czarny mat	1 48	38,85

K GRUPA RABATOWA



chrom



biały



czarny mat

ZMK1

Zestaw maskujący do grzejników z rozetą prostokątną i tulejami



indeks	kolor	pakowanie	cena netto [zł]
20-040-1030-100	chrom	1 48	57,75
20-040-1030-101	biały	1 48	57,75
20-040-1030-103	czarny mat	1 48	57,75

K GRUPA RABATOWA



chrom



biały



czarny mat

TRCD10C

Głowica termostatyczna cieczowa M30x1.5, chromowana



indeks	Tmax	pakowanie	cena netto [zł]
20-107-0400-000	+50°C	1 100	38,23

E GRUPA RABATOWA

TRCD10

Głowica termostatyczna cieczowa M30x1.5, biała



indeks	kolor	Tmax	pakowanie	cena netto [zł]
20-107-0400-100	biały	+50°C	1 100	39,74
20-107-0400-003	czarny mat	+50°C	1 100	37,49

E GRUPA RABATOWA



biały



czarny mat

TRCD15

Głowica termostatyczna cieczowa M30x1.5 z blokadą nastawy



indeks	Tmax	pakowanie	cena netto [zł]
20-107-0300-000	+50°C	1 100	33,46

E GRUPA RABATOWA

GT01RA

Głowica termostatyczna cieczowa z przyłączem RA z blokadą nastawy temperatury



indeks	Tmax	pakowanie	cena netto [zł]
20-300-0009-000	+50°C	1 100	

E GRUPA RABATOWA

dostępne w III kwartale 2024

▶ NOWOŚĆ**GT02RA**

Głowica termostatyczna cieczowa z przyłączem RA



indeks	Tmax	pakowanie	cena netto [zł]
20-300-0010-000	+50°C	1 100	

E GRUPA RABATOWA

dostępne w III kwartale 2024

▶ NOWOŚĆ**GT01**

Głowica termostatyczna cieczowa M30x1.5 z blokadą nastawy



indeks	Tmax	pakowanie	cena netto [zł]
20-107-0300-003	+50°C	1 100	25,30

E GRUPA RABATOWA

dostępne w III kwartale 2024

▶ NOWOŚĆ**GT03**

Głowica termostatyczna cieczowa M30x1.5 z blokadą nastawy



indeks	Tmax	pakowanie	cena netto [zł]
20-107-0300-004	+50°C	1 100	25,30

E GRUPA RABATOWA

dostępne w III kwartale 2024

▶ NOWOŚĆ

GT04**▶ NOWOŚĆ**

Głowica termostaticzna cieczowa M30x1.5 z blokadą nastawy



indeks	Tmax	pakowanie	cena netto [zł]
20-107-0300-005	+50°C	1 100	25,30

(E) GRUPA RABATOWA

dostępne w III kwartale 2024

PHA-028

Termostaticzny zawór grzejnikowy z nastawą wstępną, prosty

**PERFEKT²** SYSTEM

indeks	wielkość	PN	Tmax	pakowanie	cena netto [zł]
20-028-0000-000	½"	10	+120°C	10 100	50,44

(K) GRUPA RABATOWA**PHA-029**

Termostaticzny zawór grzejnikowy z nastawą wstępną, kątowy

**PERFEKT²** SYSTEM

indeks	wielkość	PN	Tmax	pakowanie	cena netto [zł]
20-029-0000-000	½"	10	+120°C	10 100	47,25

(K) GRUPA RABATOWA**PHA-030**

Zawór grzejnikowy prosty

**PERFEKT²** SYSTEM

indeks	wielkość	PN	Tmax	pakowanie	cena netto [zł]
20-030-0000-300	¾"	10	+120°C	10 100	32,68
20-030-0000-000	½"	10	+120°C	10 100	32,68

(K) GRUPA RABATOWA**PHA-031**

Zawór grzejnikowy odcinający prosty

**PERFEKT²** SYSTEM

indeks	wielkość	PN	Tmax	pakowanie	cena netto [zł]
20-031-0001-300	¾"	10	+120°C	10 100	29,63
20-031-0001-000	½"	10	+120°C	12 120	29,63

(K) GRUPA RABATOWA**PHA-032**

Zawór grzejnikowy kątowy

**PERFEKT²** SYSTEM

indeks	wielkość	PN	Tmax	pakowanie	cena netto [zł]
20-032-0100-300	¾"	10	+120°C	10 100	32,68
20-032-0100-000	½"	10	+120°C	10 100	32,68

(K) GRUPA RABATOWA**TRV02**

Zawór grzejnikowy odcinający prosty



indeks	wielkość	PN	Tmax	pakowanie	cena netto [zł]
20-107-0300-001	½"	10	+120°C	10 100	25,38

(E) GRUPA RABATOWA**TRV04**

Zawór grzejnikowy odcinający kątowy



indeks	wielkość	PN	Tmax	pakowanie	cena netto [zł]
20-107-0300-002	½"	10	+120°C	10 100	23,86

(E) GRUPA RABATOWA

PHA-030A

Zawór grzejnikowy z gwintem samouszczelniającym, prosty

**PERFEKT²SYSTEM**

indeks	wielkość	PN	Tmax	pakowanie		cena netto [zł]
20-030-0000-100	½"	10	+120°C	10	100	33,02

(K) GRUPA RABATOWA

PHA-031A

Zawór grzejnikowy odcinający z gwintem samouszczelniającym, prosty

**PERFEKT²SYSTEM**

indeks	wielkość	PN	Tmax	pakowanie		cena netto [zł]
20-031-0001-100	½"	10	+120°C	10	100	30,33

(K) GRUPA RABATOWA

PHA-032A

Zawór grzejnikowy z gwintem samouszczelniającym, kątowy

**PERFEKT²SYSTEM**

indeks	wielkość	PN	Tmax	pakowanie		cena netto [zł]
20-032-0100-100	½"	10	+120°C	10	100	32,71

(K) GRUPA RABATOWA

PHA-033A

Zawór grzejnikowy odcinający z gwintem samouszczelniającym, kątowy

**PERFEKT²SYSTEM**

indeks	wielkość	PN	Tmax	pakowanie		cena netto [zł]
20-033-0101-100	½"	10	+120°C	10	100	29,97

(K) GRUPA RABATOWA

PHA-030/L

Zawór grzejnikowy do wlotowania, prosty

**PERFEKT²SYSTEM**

indeks	wielkość	PN	Tmax	pakowanie		cena netto [zł]
20-030-0000-200	½" x 15	10	+120°C	10	100	24,68

(K) GRUPA RABATOWA

Produkt dostępny do wyczerpania zapasów

PHA-033

Zawór grzejnikowy odcinający kątowy

**PERFEKT²SYSTEM**

indeks	wielkość	PN	Tmax	pakowanie		cena netto [zł]
20-033-0101-300	¾"	10	+120°C	10	100	29,63
20-033-0101-000	½"	10	+120°C	12	120	29,63

(K) GRUPA RABATOWA

PHA-032/L

Zawór grzejnikowy do wlotowania, kątowy

**PERFEKT²SYSTEM**

indeks	wielkość	PN	Tmax	pakowanie		cena netto [zł]
20-032-0100-200	½" x 15	10	+120°C	10	100	24,68

(K) GRUPA RABATOWA

Produkt dostępny do wyczerpania zapasów

PHA-033/L

Zawór grzejnikowy odcinający do wlotowania, kątowy

PERFEKT^{SYSTEM}

indeks	wielkość	PN	Tmax	pakowanie		cena netto [zł]
20-033-0101-200	½" x 15	10	+120°C	10	100	21,08

(K) GRUPA RABATOWA

Produkt dostępny do wyczerpania zapasów

PHA-030/PEX

Zawór grzejnikowy ze złączką do rury PEX lub PERT prosty

PERFEKT^{SYSTEM}

indeks	wielkość	PN	Tmax	pakowanie		cena netto [zł]
20-030-0000-003	½"	10	+120°C	10	100	28,46

(K) GRUPA RABATOWA

PHA-031/PEX

Zawór grzejnikowy odcinający ze złączką do rury PEX lub PERT prosty

PERFEKT^{SYSTEM}

indeks	wielkość	PN	Tmax	pakowanie		cena netto [zł]
20-031-0001-003	½"	10	+120°C	10	100	24,92

(K) GRUPA RABATOWA

PHA-032/PEX

Zawór grzejnikowy ze złączką do rury PEX lub PERT kątowy

PERFEKT^{SYSTEM}

indeks	wielkość	PN	Tmax	pakowanie		cena netto [zł]
20-032-0100-003	½"	10	+120°C	10	100	27,53

(K) GRUPA RABATOWA

PHA-033/PEX

Zawór grzejnikowy odcinający ze złączką do rury PEX lub PERT kątowy

PERFEKT^{SYSTEM}

indeks	wielkość	PN	Tmax	pakowanie		cena netto [zł]
20-033-0101-003	½"	10	+120°C	10	100	24,92

(K) GRUPA RABATOWA

PHA-034

Zawór grzejnikowy podwójny grzybkowy odcinający prosty z nyplami

PERFEKT^{SYSTEM}

indeks	wielkość	PN	Tmax	pakowanie		cena netto [zł]
20-034-0000-000	½" x ¾"	10	+120°C	8	80	65,16

(K) GRUPA RABATOWA

PHA-035

Zawór grzejnikowy podwójny grzybkowy odcinający kątowy z nyplami

PERFEKT^{SYSTEM}

indeks	wielkość	PN	Tmax	pakowanie		cena netto [zł]
20-035-0000-000	½" x ¾"	10	+120°C	8	80	56,18

(K) GRUPA RABATOWA

PHA-035/1

Zawór grzejnikowy podwójny grzybkowy odcinający kątowy bez nypli

PERFEKT² SYSTEM

indeks	wielkość	PN	Tmax	pakowanie		cena netto [zł]
20-035-0000-001	½" x ¾"	10	+120°C	8	80	47,40

(K) GRUPA RABATOWA

7006+8021

Zawór grzejnikowy podwójny kulowy odcinający prosty z nyplami



indeks	wielkość	PN	Tmax	pakowanie		cena netto [zł]
20-104-0002-000	½" x ¾"	10	+120°C	10	100	63,54

(E) GRUPA RABATOWA

7005+8021

Zawór grzejnikowy podwójny kulowy odcinający kątowy z nyplami



indeks	wielkość	PN	Tmax	pakowanie		cena netto [zł]
20-104-0001-000	½" x ¾"	10	+120°C	10	100	60,64

(E) GRUPA RABATOWA

8021/S

Nypel do zaworu grzejnikowego (PHA-034 i PHA-035)



indeks	wielkość	PN	Tmax	pakowanie		cena netto [zł]
20-104-2001-000	½" x ¾"	10	+120°C	10	700	8,69

(K) GRUPA RABATOWA

8021

Nypel do zaworu grzejnikowego kulowego podwójnego (a.7005 i a.7006)



indeks	wielkość	PN	Tmax	pakowanie		cena netto [zł]
20-104-2000-000	½" x ¾"	10	+110°C	10	1000	8,44

(E) GRUPA RABATOWA

**111-1(110/L)
111-3(110/L)**

Zawór bezpieczeństwa z zaworem zwrotnym i spustem



indeks	DN	ciśnienie nastawne [bar]	Tmax	pakowanie		cena netto [zł]
20-201-0150-000	15	7	+100°C	1	150	31,57
20-201-0200-000	20	7	+100°C	1	125	40,73

(C) GRUPA RABATOWA

7036B

Zawór bezpieczeństwa z zaworem zwrotnym i spustem



indeks	DN	ciśnienie nastawne [bar]	Tmax	pakowanie		cena netto [zł]
20-202-0150-000	15	7	+95°C	20	200	17,55
20-202-0200-000	20	7	+95°C	10	100	33,94

(E) GRUPA RABATOWA

PHA-402

Pompa obiegowa PERFEKT do instalacji c.o. sterowana elektronicznie

PERFEKT^{SYSTEM}

indeks	wielkość	wysokość podnoszenia (m)	pakowanie	cena netto [zł]
31-402-0000-000	180 mm	4	1 8	632,18

P GRUPA RABATOWA

PHA-602

Pompa obiegowa PERFEKT do instalacji c.o. sterowana elektronicznie

PERFEKT^{SYSTEM}

indeks	wielkość	wysokość podnoszenia (m)	pakowanie	cena netto [zł]
31-602-0000-000	180 mm	6	1 8	653,67

P GRUPA RABATOWA

PHA-602/P

Pompa obiegowa PERFEKT do instalacji c.o. ogrzewania podłogowego sterowana elektronicznie

PERFEKT^{SYSTEM}

indeks	wielkość	wysokość podnoszenia (m)	pakowanie	cena netto [zł]
31-602-0001-000	130 mm	6	1 8	653,67

P GRUPA RABATOWA

CRS25/40

Pompa obiegowa do wody pitnej

PERFEKT^{SYSTEM}

indeks	wielkość	wysokość podnoszenia (m)	pakowanie	cena netto [zł]
31-254-0000-000	180 mm	4	1 8	226,50

P GRUPA RABATOWA

CRS25/60

Pompa obiegowa do wody pitnej

PERFEKT^{SYSTEM}

indeks	wielkość	wysokość podnoszenia (m)	pakowanie	cena netto [zł]
31-256-0000-000	180 mm	6	1 8	230,79

P GRUPA RABATOWA

SP

Śrubunek z uszczelką do pompy

PERFEKT^{SYSTEM}

indeks	wielkość	PN	Tmax	pakowanie	cena netto [zł]
31-900-0002-000	1" x 1½"	10	+100°C	1 100	7,80

P GRUPA RABATOWA

PHA-100Rozdzielacz mosiężny
grzejnikowy prosty**(K1)** GRUPA RABATOWA**PERFEKT^Q**
SYSTEM

indeks	ilość obwodów	PN	Tmax	pakowanie		cena netto [zł]
30-100-0202-000	2	10	+95°C	1	1	153,26
30-100-0302-000	3	10	+95°C	1	1	210,48
30-100-0402-000	4	10	+95°C	1	1	271,37
30-100-0502-000	5	10	+95°C	1	1	330,07
30-100-0602-000	6	10	+95°C	1	1	386,38
30-100-0702-000	7	10	+95°C	1	1	447,17
30-100-0802-000	8	10	+95°C	1	1	497,52
30-100-0902-000	9	10	+95°C	1	1	550,29
30-100-1002-000	10	10	+95°C	1	1	600,53
30-100-1102-000	11	10	+95°C	1	1	658,33
30-100-1202-000	12	10	+95°C	1	1	711,11

PHA-102Rozdzielacz mosiężny
grzejnikowy prosty
z nyplami**(K1)** GRUPA RABATOWA**PERFEKT^Q**
SYSTEM

indeks	ilość obwodów	PN	Tmax	pakowanie		cena netto [zł]
30-102-0202-000	2	10	+95°C	1	1	206,00
30-102-0302-000	3	10	+95°C	1	1	291,10
30-102-0402-000	4	10	+95°C	1	1	362,77
30-102-0502-000	5	10	+95°C	1	1	459,07
30-102-0602-000	6	10	+95°C	1	1	535,21
30-102-0702-000	7	10	+95°C	1	1	606,86
30-102-0802-000	8	10	+95°C	1	1	703,15
30-102-0902-000	9	10	+95°C	1	1	779,30
30-102-1002-000	10	10	+95°C	1	1	868,86
30-102-1102-000	11	10	+95°C	1	1	951,73
30-102-1202-000	12	10	+95°C	1	1	1034,97

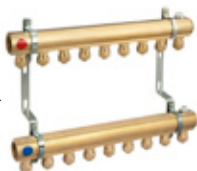
PHA-102/ZRozdzielacz mosiężny
ze złączkami do rur PEX**(K1)** GRUPA RABATOWA**PERFEKT^Q**
SYSTEM

indeks	ilość obwodów	PN	Tmax	pakowanie		cena netto [zł]
30-102-0200-004	2	10	+95°C	1	1	234,26
30-102-0300-004	3	10	+95°C	1	1	332,76
30-102-0400-004	4	10	+95°C	1	1	417,28
30-102-0500-004	5	10	+95°C	1	1	527,42
30-102-0600-004	6	10	+95°C	1	1	616,63
30-102-0700-004	7	10	+95°C	1	1	701,16
30-102-0800-004	8	10	+95°C	1	1	811,29
30-102-0900-004	9	10	+95°C	1	1	900,48
30-102-1000-004	10	10	+95°C	1	1	1003,66
30-102-1100-004	11	10	+95°C	1	1	1099,81
30-102-1200-004	12	10	+95°C	1	1	1196,41

PHA-107

Rozdzielacz mosiężny z rotametrem 0-5l do ogrzewania podłogowego

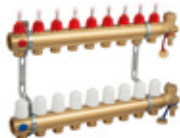

 GRUPA RABATOWA

Możliwość podłączenia zespołu mieszającego - rozstaw 210mm.



 **NOWOŚĆ**

PERFEKT^{SYSTEM}

indeks	ilość obwodów	PN	Tmax	pakowanie		cena netto [zł]
						
30-107-0200-000	2	6	+70°C	1	1	340,00
30-107-0300-000	3	6	+70°C	1	1	440,00
30-107-0400-000	4	6	+70°C	1	1	540,00
30-107-0500-000	5	6	+70°C	1	1	640,00
30-107-0600-000	6	6	+70°C	1	1	730,00
30-107-0700-000	7	6	+70°C	1	1	830,00
30-107-0800-000	8	6	+70°C	1	1	920,00
30-107-0900-000	9	6	+70°C	1	1	1020,00
30-107-1000-000	10	6	+70°C	1	1	1120,00
30-107-1100-000	11	6	+70°C	1	1	1220,00
30-107-1200-000	12	6	+70°C	1	1	1310,00
30-107-1300-000	13	6	+70°C	1	1	1480,00
30-107-1400-000	14	6	+70°C	1	1	1580,00
30-107-1500-000	15	6	+70°C	1	1	1680,00
30-107-1600-000	16	6	+70°C	1	1	1780,00

PHA-107/Z

Rozdzielacz mosiężny z rotametrem 0-5l, ze złączkami do rur PEX - do ogrzewania podłogowego

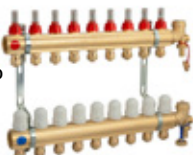

 GRUPA RABATOWA

Możliwość podłączenia zespołu mieszającego - rozstaw 210mm.



 **NOWOŚĆ**

PERFEKT^{SYSTEM}

indeks	ilość obwodów	PN	Tmax	pakowanie		cena netto [zł]
						
30-107-0200-004	2	6	+70°C	1	1	388,00
30-107-0300-004	3	6	+70°C	1	1	512,00
30-107-0400-004	4	6	+70°C	1	1	636,00
30-107-0500-004	5	6	+70°C	1	1	760,00
30-107-0600-004	6	6	+70°C	1	1	874,00
30-107-0700-004	7	6	+70°C	1	1	998,00
30-107-0800-004	8	6	+70°C	1	1	1112,00
30-107-0900-004	9	6	+70°C	1	1	1236,00
30-107-1000-004	10	6	+70°C	1	1	1360,00
30-107-1100-004	11	6	+70°C	1	1	1484,00
30-107-1200-004	12	6	+70°C	1	1	1598,00
30-107-1300-004	13	6	+70°C	1	1	1792,00
30-107-1400-004	14	6	+70°C	1	1	1916,00
30-107-1500-004	15	6	+70°C	1	1	2040,00
30-107-1600-004	16	6	+70°C	1	1	2164,00



PHA-107/1/S

Rozdzielacz mosiężny z rotametrem 0-5l do ogrzewania podłogowego

 GRUPA RABATOWA

Możliwość podłączenia zespołu mieszającego - rozstaw 210mm.

PERFEKT^{SYSTEM}

indeks	ilość obwodów	PN	Tmax	pakowanie		cena netto [zł]
						
30-107-0200-011	2	6	+70°C	1	1	310,00
30-107-0300-011	3	6	+70°C	1	1	410,00
30-107-0400-011	4	6	+70°C	1	1	510,00
30-107-0500-011	5	6	+70°C	1	1	610,00
30-107-0600-011	6	6	+70°C	1	1	700,00
30-107-0700-011	7	6	+70°C	1	1	800,00
30-107-0800-011	8	6	+70°C	1	1	890,00
30-107-0900-011	9	6	+70°C	1	1	990,00
30-107-1000-011	10	6	+70°C	1	1	1090,00
30-107-1100-011	11	6	+70°C	1	1	1190,00
30-107-1200-011	12	6	+70°C	1	1	1280,00
30-107-1300-011	13	6	+70°C	1	1	1420,00
30-107-1400-011	14	6	+70°C	1	1	1520,00
30-107-1500-011	15	6	+70°C	1	1	1620,00
30-107-1600-011	16	6	+70°C	1	1	1720,00

PHA-107/1/S/Z

Rozdzielacz mosiężny
ze złączkami do rur
warstwowych

K3 GRUPA RABATOWA

NOWOŚĆ

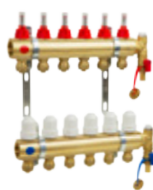

Możliwość podłączenia zespołu
mieszającego - rozstaw 210mm.

PERFEKT²
SYSTEM



indeks	ilość obwodów	PN	Tmax	pakowanie		cena netto [zł]
30-107-0200-014	2	6	+70°C	1	1	358,00
30-107-0300-014	3	6	+70°C	1	1	482,00
30-107-0400-014	4	6	+70°C	1	1	606,00
30-107-0500-014	5	6	+70°C	1	1	730,00
30-107-0600-014	6	6	+70°C	1	1	844,00
30-107-0700-014	7	6	+70°C	1	1	968,00
30-107-0800-014	8	6	+70°C	1	1	1082,00
30-107-0900-014	9	6	+70°C	1	1	1206,00
30-107-1000-014	10	6	+70°C	1	1	1330,00
30-107-1100-014	11	6	+70°C	1	1	1454,00
30-107-1200-014	12	6	+70°C	1	1	1568,00
30-107-1300-014	13	6	+70°C	1	1	1732,00
30-107-1400-014	14	6	+70°C	1	1	1856,00
30-107-1500-014	15	6	+70°C	1	1	1980,00
30-107-1600-014	16	6	+70°C	1	1	2104,00

PHA-109

Rozdzielacz mosiężny
z wkładkami zaworowymi
odcinającymi

K2 GRUPA RABATOWA



PERFEKT²
SYSTEM



indeks	ilość obwodów	PN	Tmax	pakowanie		cena netto [zł]
30-109-0200-000	2	10	+95°C	1	1	224,08
30-109-0300-000	3	10	+95°C	1	1	311,21
30-109-0400-000	4	10	+95°C	1	1	404,58
30-109-0500-000	5	10	+95°C	1	1	506,27
30-109-0600-000	6	10	+95°C	1	1	587,16
30-109-0700-000	7	10	+95°C	1	1	676,40
30-109-0800-000	8	10	+95°C	1	1	746,94
30-109-0900-000	9	10	+95°C	1	1	840,29
30-109-1000-000	10	10	+95°C	1	1	910,85
30-109-1100-000	11	10	+95°C	1	1	995,92
30-109-1200-000	12	10	+95°C	1	1	1089,28

PHA-109A

Rozdzielacz mosiężny
- komplet

K2 GRUPA RABATOWA

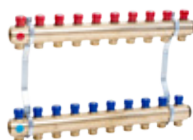

PERFEKT²
SYSTEM

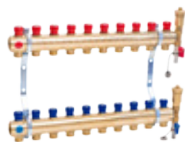

indeks	ilość obwodów	PN	Tmax	pakowanie		cena netto [zł]
30-109-0200-002	2	10	+95°C	1	1	232,55
30-109-0300-002	3	10	+95°C	1	1	322,97
30-109-0400-002	4	10	+95°C	1	1	419,86
30-109-0500-002	5	10	+95°C	1	1	525,35
30-109-0600-002	6	10	+95°C	1	1	609,33
30-109-0700-002	7	10	+95°C	1	1	701,92
30-109-0800-002	8	10	+95°C	1	1	775,12
30-109-0900-002	9	10	+95°C	1	1	872,00
30-109-1000-002	10	10	+95°C	1	1	945,57
30-109-1100-002	11	10	+95°C	1	1	1033,36
30-109-1200-002	12	10	+95°C	1	1	1130,38

PHA-109A/1Rozdzielacz mosiężny
- komplet**K2** GRUPA RABATOWA**PERFEKT**^{SYSTEM}

indeks	ilość obwodów	PN	Tmax	pakowanie	cena netto [zł]
30-109-0200-001	2	10	+95°C	1 1	340,26
30-109-0300-001	3	10	+95°C	1 1	428,46
30-109-0400-001	4	10	+95°C	1 1	516,67
30-109-0500-001	5	10	+95°C	1 1	608,46
30-109-0600-001	6	10	+95°C	1 1	693,10
30-109-0700-001	7	10	+95°C	1 1	777,71
30-109-0800-001	8	10	+95°C	1 1	864,13
30-109-0900-001	9	10	+95°C	1 1	955,93
30-109-1000-001	10	10	+95°C	1 1	1040,55
30-109-1100-001	11	10	+95°C	1 1	1128,77
30-109-1200-001	12	10	+95°C	1 1	1216,98

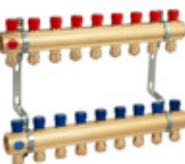
PHA-109A/ZRozdzielacz mosiężny
z wkładkami zaworowymi
odcinającymi ze złączkami
do rur PEX - komplet**K2** GRUPA RABATOWA**PERFEKT**^{SYSTEM}

indeks	ilość obwodów	PN	Tmax	pakowanie	cena netto [zł]
30-109-0200-004	2	10	+95°C	1 1	230,49
30-109-0300-004	3	10	+95°C	1 1	350,70
30-109-0400-004	4	10	+95°C	1 1	456,87
30-109-0500-004	5	10	+95°C	1 1	571,61
30-109-0600-004	6	10	+95°C	1 1	664,82
30-109-0700-004	7	10	+95°C	1 1	766,66
30-109-0800-004	8	10	+95°C	1 1	849,10
30-109-0900-004	9	10	+95°C	1 1	955,24
30-109-1000-004	10	10	+95°C	1 1	1038,04
30-109-1100-004	11	10	+95°C	1 1	1135,08
30-109-1200-004	12	10	+95°C	1 1	1241,36

PHA-120Rozdzielacz ze stali
nierdzewnej**K1** GRUPA RABATOWA**PERFEKT**^{SYSTEM}

indeks	ilość obwodów	PN	Tmax	pakowanie	cena netto [zł]
30-120-0200-001	2	10	+95°C	1 1	138,28
30-120-0300-001	3	10	+95°C	1 1	191,07
30-120-0400-001	4	10	+95°C	1 1	235,14
30-120-0500-001	5	10	+95°C	1 1	279,25
30-120-0600-001	6	10	+95°C	1 1	320,39
30-120-0700-001	7	10	+95°C	1 1	363,02
30-120-0800-001	8	10	+95°C	1 1	404,16
30-120-0900-001	9	10	+95°C	1 1	442,40
30-120-1000-001	10	10	+95°C	1 1	479,14
30-120-1100-001	11	10	+95°C	1 1	529,11
30-120-1200-001	12	10	+95°C	1 1	571,72

PHA-122Rozdzielacz ze stali
nierdzewnej z nypłami**K1** GRUPA RABATOWA**PERFEKT**^{SYSTEM}

indeks	ilość obwodów	PN	Tmax	pakowanie	cena netto [zł]
30-122-0200-001	2	10	+95°C	1 1	177,11
30-122-0300-001	3	10	+95°C	1 1	242,19
30-122-0400-001	4	10	+95°C	1 1	302,77
30-122-0500-001	5	10	+95°C	1 1	363,32
30-122-0600-001	6	10	+95°C	1 1	420,83
30-122-0700-001	7	10	+95°C	1 1	479,89
30-122-0800-001	8	10	+95°C	1 1	537,40
30-122-0900-001	9	10	+95°C	1 1	591,88
30-122-1000-001	10	10	+95°C	1 1	644,88
30-122-1100-001	11	10	+95°C	1 1	711,49
30-122-1200-001	12	10	+95°C	1 1	770,52

PHA-127

Rozdzielacz ze stali nierdzewnej z rotametrem 0-5l do ogrzewania podłogowego

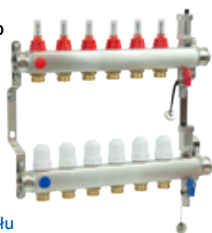

 GRUPA RABATOWA



Możliwość podłączenia zespołu mieszającego - rozstaw 210mm.

 **NOWOŚĆ**

PERFEKT²SYSTEM

indeks	ilość obwodów	PN	Tmax	pakowanie		cena netto [zł]
						
30-127-0200-001	2	6	+70°C	1	1	378,00
30-127-0300-001	3	6	+70°C	1	1	473,00
30-127-0400-001	4	6	+70°C	1	1	574,00
30-127-0500-001	5	6	+70°C	1	1	670,00
30-127-0600-001	6	6	+70°C	1	1	770,00
30-127-0700-001	7	6	+70°C	1	1	868,00
30-127-0800-001	8	6	+70°C	1	1	963,00
30-127-0900-001	9	6	+70°C	1	1	1062,00
30-127-1000-001	10	6	+70°C	1	1	1160,00
30-127-1100-001	11	6	+70°C	1	1	1244,00
30-127-1200-001	12	6	+70°C	1	1	1347,00
30-127-1300-001	13	6	+70°C	1	1	1469,00
30-127-1400-001	14	6	+70°C	1	1	1571,00
30-127-1500-001	15	6	+70°C	1	1	1671,00
30-127-1600-001	16	6	+70°C	1	1	1775,00

PHA-127/Z

 **NOWOŚĆ**



Rozdzielacz ze stali nierdzewnej ze złączkami do rur wielowarstwowych

 GRUPA RABATOWA



Możliwość podłączenia zespołu mieszającego - rozstaw 210mm.

PERFEKT²SYSTEM

indeks	ilość obwodów	PN	Tmax	pakowanie		cena netto [zł]
						
30-127-0200-004	2	6	+70°C	1	1	426,00
30-127-0300-004	3	6	+70°C	1	1	545,00
30-127-0400-004	4	6	+70°C	1	1	670,00
30-127-0500-004	5	6	+70°C	1	1	790,00
30-127-0600-004	6	6	+70°C	1	1	914,00
30-127-0700-004	7	6	+70°C	1	1	1036,00
30-127-0800-004	8	6	+70°C	1	1	1155,00
30-127-0900-004	9	6	+70°C	1	1	1278,00
30-127-1000-004	10	6	+70°C	1	1	1400,00
30-127-1100-004	11	6	+70°C	1	1	1508,00
30-127-1200-004	12	6	+70°C	1	1	1635,00
30-127-1300-004	13	6	+70°C	1	1	1781,00
30-127-1400-004	14	6	+70°C	1	1	1907,00
30-127-1500-004	15	6	+70°C	1	1	2031,00
30-127-1600-004	16	6	+70°C	1	1	2159,00

PHA-127/1/S

 **NOWOŚĆ**

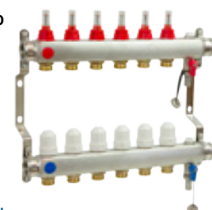

Rozdzielacz ze stali nierdzewnej z rotametrem 0-5l do ogrzewania podłogowego

 GRUPA RABATOWA



Możliwość podłączenia zespołu mieszającego - rozstaw 210mm.

PERFEKT²SYSTEM

indeks	ilość obwodów	PN	Tmax	pakowanie		cena netto [zł]
						
30-127-0200-011	2	6	+70°C	1	1	348,00
30-127-0300-011	3	6	+70°C	1	1	443,00
30-127-0400-011	4	6	+70°C	1	1	544,00
30-127-0500-011	5	6	+70°C	1	1	640,00
30-127-0600-011	6	6	+70°C	1	1	740,00
30-127-0700-011	7	6	+70°C	1	1	838,00
30-127-0800-011	8	6	+70°C	1	1	933,00
30-127-0900-011	9	6	+70°C	1	1	1032,00
30-127-1000-011	10	6	+70°C	1	1	1130,00
30-127-1100-011	11	6	+70°C	1	1	1214,00
30-127-1200-011	12	6	+70°C	1	1	1317,00
30-127-1300-011	13	6	+70°C	1	1	1439,00
30-127-1400-011	14	6	+70°C	1	1	1541,00
30-127-1500-011	15	6	+70°C	1	1	1641,00
30-127-1600-011	16	6	+70°C	1	1	1745,00

PHA-127/1/S/Z

NOWOŚĆ

PERFEKT² SYSTEM

Rozdzielacz ze stali nierdzewnej
ze złączkami do rur
wielowarstwowych

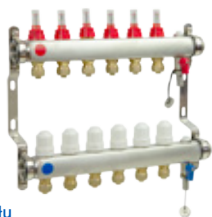

K3 GRUPA RABATOWA

Możliwość podłączenia zespołu
mieszającego - rozstaw 210mm.

indeks	ilość obwodów	PN	Tmax	pakowanie		cena netto [zł]
30-127-0200-014	2	6	+70°C	1	1	396,00
30-127-0300-014	3	6	+70°C	1	1	515,00
30-127-0400-014	4	6	+70°C	1	1	640,00
30-127-0500-014	5	6	+70°C	1	1	760,00
30-127-0600-014	6	6	+70°C	1	1	884,00
30-127-0700-014	7	6	+70°C	1	1	1006,00
30-127-0800-014	8	6	+70°C	1	1	1125,00
30-127-0900-014	9	6	+70°C	1	1	1248,00
30-127-1000-014	10	6	+70°C	1	1	1370,00
30-127-1100-014	11	6	+70°C	1	1	1478,00
30-127-1200-014	12	6	+70°C	1	1	1605,00
30-127-1300-014	13	6	+70°C	1	1	1751,00
30-127-1400-014	14	6	+70°C	1	1	1877,00
30-127-1500-014	15	6	+70°C	1	1	2001,00
30-127-1600-014	16	6	+70°C	1	1	2129,00

PHA-129A/1

PERFEKT² SYSTEM

Rozdzielacz ze stali
nierdzewnej - komplet

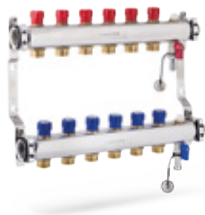

K2 GRUPA RABATOWA

indeks	ilość obwodów	PN	Tmax	pakowanie		cena netto [zł]
30-129-0200-001	2	10	+95°C	1	1	360,98
30-129-0300-001	3	10	+95°C	1	1	461,73
30-129-0400-001	4	10	+95°C	1	1	554,07
30-129-0500-001	5	10	+95°C	1	1	654,82
30-129-0600-001	6	10	+95°C	1	1	738,75
30-129-0700-001	7	10	+95°C	1	1	822,71
30-129-0800-001	8	10	+95°C	1	1	898,28
30-129-0900-001	9	10	+95°C	1	1	990,61
30-129-1000-001	10	10	+95°C	1	1	1082,96
30-129-1100-001	11	10	+95°C	1	1	1175,30
30-129-1200-001	12	10	+95°C	1	1	1259,28

PHA-131

Zespół mieszający do ogrzewania podłogowego z pompą Grundfos i zaworem trójdrożnym termost. temp. 20-43°C kv2.5



(K2) GRUPA RABATOWA

PERFEKT²SYSTEM

indeks	PN	Tmax	pakowanie	cena netto [zł]
30-600-0000-003	10	+75°C	1 4	2317,79

PHA-131/1

Zespół mieszający do ogrzewania podłogowego z pompą Grundfos i z-rem trójdrożnym termost.temp.20-43°C, kv 2,5 i uchwytem 555/1



(K2) GRUPA RABATOWA

PERFEKT²SYSTEM

indeks	PN	Tmax	pakowanie	cena netto [zł]
30-600-0000-006	10	+75°C	1 8	2350,80

PHA-132

NOWOŚĆ

Trójdrożny termostatyczny zawór mieszający



(K) GRUPA RABATOWA

PERFEKT²SYSTEM

indeks	wielkość	PN	Tmax	pakowanie	cena netto [zł]
30-601-0250-000	1"	10	+70°C	1 40	185,00

PHA-061M

Separator magnetyczny



(K) GRUPA RABATOWA

PERFEKT²SYSTEM

indeks	wielkość	Magnes neodymowy	Tmax	pakowanie	cena netto [zł]
03-061-0200-000	¾"	9000 Gs	+90°C	1 10	240,00

PHA-063M

Separator magnetyczny



(K) GRUPA RABATOWA

PERFEKT²SYSTEM

indeks	wielkość	Magnes neodymowy	Tmax	pakowanie	cena netto [zł]
03-063-0250-000	1"	12000 Gs	+90°C	1 6	510,00
03-063-0320-000	1¼"	12000 Gs	+90°C	1 6	600,00

PHA-064M

NOWOŚĆ

Separator magnetyczny MAX FLOW z filtrem i odpowietrznikiem



(K) GRUPA RABATOWA

PERFEKT²SYSTEM

indeks	wielkość	Przepływ Qm³/h	Magnes neodymowy	Tmax	pakowanie	cena netto [zł]
03-064-0250-000	1"	4,37	9000 Gs	+90°C	1 6	535,00
03-064-0320-000	1¼"	4,95	9000 Gs	+90°C	1 6	635,00

PHA-090

Zacisk do rur PEX lub PERT

PERFEKT² SYSTEM

indeks	wielkość	PN	Tmax	pakowanie	cena netto [zł]
20-090-0000-000	16 x 2	10	+90°C	10 280	8,00

(K) GRUPA RABATOWA

PHA-090/1

Zacisk do rur wielowarstwowych

PERFEKT² SYSTEM

indeks	wielkość	PN	Tmax	pakowanie	cena netto [zł]
20-090-0160-001	16 x 2	10	+90°C	10 280	
20-090-0170-001	17 x 2	10	+90°C		8,65
20-090-0180-001	18 x 2	10	+90°C		8,85
20-090-0200-001	20 x 2	10	+90°C		10,62

(K) GRUPA RABATOWA
dostępne w III kwartale 2024**215E**

Zacisk do rur miedzianych

PERFEKT² SYSTEM

indeks	wielkość	PN	Tmax	pakowanie	cena netto [zł]
20-104-9001-000	ø15	10	+100°C	30 240	10,57

(E) GRUPA RABATOWA

PHA-098

Zespół odpowietrzająco spustowy do rozdzielacza

PERFEKT² SYSTEM

indeks	kolor	PN	Tmax	pakowanie	cena netto [zł]
30-200-0980-000	czerny	10	+120°C	10 40	68,69
30-200-0980-010	niebieski	10	+120°C	10 40	68,69

(K) GRUPA RABATOWA

SS555/1

Uchwyt do rozdzielacza ze stali nierdzewnej



indeks	rozstaw [mm]	pakowanie	cena netto [zł]
30-200-5551-200	210	1 60	25,09

(D) GRUPA RABATOWA

555/1

Uchwyt do rozdzielaczy mosiężnych serii PHA-107



30-200-5551-000	210	1 60	15,61
------------------------	-----	------	--------------

(D) GRUPA RABATOWA

748U

Nypel do belki rozdzielacza mosiężnego uniwersalny



indeks	wielkość	PN	Tmax	pakowanie	cena netto [zł]
30-200-7480-002	1/2" x 3/4"	10	+95°C	125 500	9,66

(K2) GRUPA RABATOWA

749

Korek do belki rozdzielacza mosiężnego



indeks	PN	Tmax	pakowanie	cena netto [zł]
30-200-7490-000	10	+95°C	100 400	10,15

(D) GRUPA RABATOWA

762

Złączka wkrętna-nypel z wymiową końcówką do wkładek zaworowych do rozdzielaczy



indeks	PN	Tmax	pakowanie		cena netto [zł]
30-200-7550-020	10	+95°C	10	200	16,27

D GRUPA RABATOWA

763

Złączka wkrętna-nypel z wymiową końcówką do wkładek zaworowych do rozdzielaczy



indeks	PN	Tmax	pakowanie		cena netto [zł]
30-200-7550-021	10	+95°C	100	400	8,50

D GRUPA RABATOWA

750

Wkładka zaworowa regulacyjna do belki rozdzielacza mosiężnego



indeks	PN	Tmax	pakowanie		cena netto [zł]
30-200-7500-000	10	+95°C	10	100	42,21

D GRUPA RABATOWA

751

Wkładka zaworowa odcinająca do belki rozdzielacza mosiężnego



indeks	PN	Tmax	pakowanie		cena netto [zł]
30-200-7510-000	10	+95°C	1	10	34,47

D GRUPA RABATOWA

757

Wkładka zaworowa odcinająco-regulacyjna do belki rozdzielacza mosiężnego



indeks	PN	Tmax	pakowanie		cena netto [zł]
30-200-7570-000	10	+95°C	10	100	40,10
30-200-7570-010	10	+95°C	10	100	40,10

D GRUPA RABATOWA

753

Przepływomierz P1/2" 0-5l/min z nypem do belki rozdzielacza mosiężnego



indeks	PN	Tmax	pakowanie		cena netto [zł]
30-200-7530-000	6	+70°C	1	1	22,29

D GRUPA RABATOWA

752

Głowica termostatyczna M30x1.5 z kapilarą



indeks	wielkość	pakowanie		cena netto [zł]
30-200-7520-000	M30x1.5	1	50	154,57

D GRUPA RABATOWA

747

Trójnik do belki rozdzielacza mosiężnego



indeks	wielkość	pakowanie		cena netto [zł]
30-200-7470-000	½" x 1" x ½"	10	200	20,83

D

GRUPA RABATOWA

9003+S

Odpowietrznik automatyczny z zaworem stopowym, mosiężny



indeks	wielkość	PN	Tmax	pakowanie		cena netto [zł]
20-400-0003-000	½"	10	+110°C	1	100	27,58

B

GRUPA RABATOWA

9003C+S

Odpowietrznik automatyczny z zaworem stopowym, chromowany



indeks	wielkość	PN	Tmax	pakowanie		cena netto [zł]
20-400-0003-001	½"	10	+110°C	1	100	28,43

B

GRUPA RABATOWA

418

Odpowietrznik ręczny



indeks	wielkość	PN	Tmax	pakowanie		cena netto [zł]
20-401-0150-001	½"	10	+120°C	100	500	6,55

E

GRUPA RABATOWA

417

Odpowietrznik ręczny o-ring



indeks	wielkość	PN	Tmax	pakowanie		cena netto [zł]
20-401-0150-000	½"	10	+120°C	10	600	4,26

E

GRUPA RABATOWA

4220

Kluczyk do odpowietrznika ręcznego o-ring



indeks	pakowanie		cena netto [zł]
20-402-0001-000	500	2500	1,46

E

GRUPA RABATOWA

4216

Korek zaślepiający o-ring



indeks	wielkość	PN	Tmax	pakowanie		cena netto [zł]
20-402-0000-000	½"	10	+120°C	100	1000	3,15

E

GRUPA RABATOWA

TS+5.11/230

Siłownik termiczny
beźprądowo zamknięty
M30x1,5

PERFEKT²SYSTEM

indeks	wielkość	pakowanie		cena netto [zł]
32-000-0000-000	M30x1,5	1	40	112,64

(K2) GRUPA RABATOWA

E200

Regulator temperatury
cyfrowy tygodniowy

PERFEKT²SYSTEM

indeks	pakowanie		cena netto [zł]
32-000-1000-000	1	48	332,38

(K2) GRUPA RABATOWA

RTR3520

Termostat pokojowy

PERFEKT²SYSTEM

indeks	pakowanie		cena netto [zł]
32-000-3000-000	1	25	64,75

(K2) GRUPA RABATOWA

INSTAT868A1A

Odbiornik radiowy
do siłowników i pomp

PERFEKT²SYSTEM

indeks	pakowanie		cena netto [zł]
32-000-0001-000	1	1	304,11

(K2) GRUPA RABATOWA

B-002

Komplet uchwyty
do bojlera



indeks	pakowanie		cena netto [zł]
20-900-0001-000	1	5	69,61

(E) GRUPA RABATOWA

B-003

Komplet uchwyty
do zbiornika
wyrównawczego



indeks	pakowanie		cena netto [zł]
20-900-0002-000	1	5	50,60

(E) GRUPA RABATOWA



Pełny kompletny system
- gwarancja jakości
i zadowolenia

PERFEXIM

CENNIK ARMATURA 2024



PERFEKT[?]SYSTEM⁺

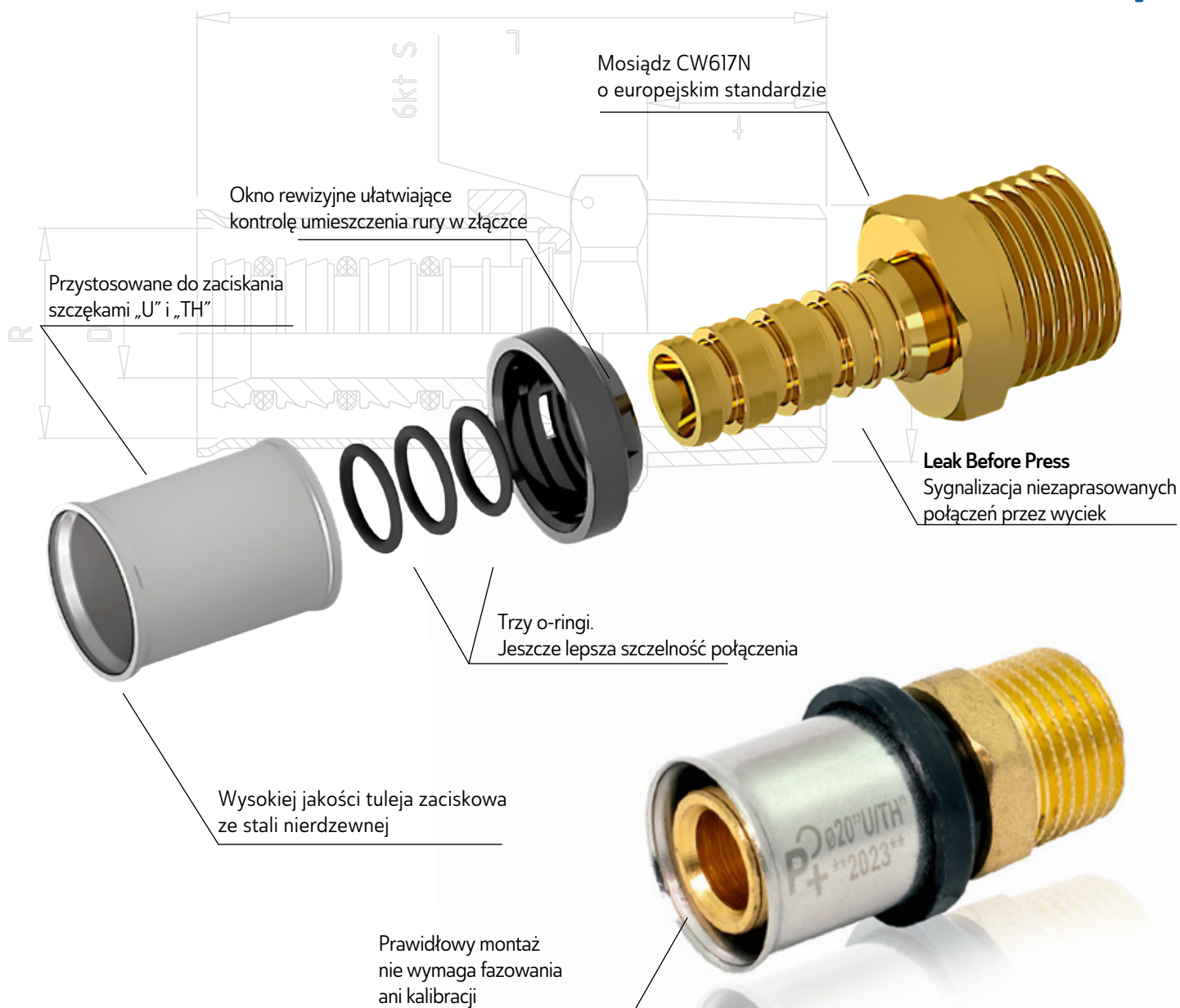

SYSTEMY RUROWE WIELOWARSTWOWE 55-67

Rury PERT		56
Rury PEX		56
Złączki zaprasowywane	PERFEKT [?] SYSTEM ⁺	57
Złączki zaprasowywane	PERFEKT [?] SYSTEM	60
Złączki skręcane		63
System montażowy		66
Narzędzia		67

PARAMETRY

Parametry pracy rur wielowarstwowych PERT/AL/PERT, PEX/AL/PE oraz złączek skręcanych i zaprasowywanych są determinowane normą EN21003, która obecnie obowiązuje w Polsce.

Klasa	Pmax	Tmax
1	1,0 MPa	+60°C
5	0,6 MPa	+90°C

Parametry pracy rur wielowarstwowych PERT/EVOH/PERT

Klasa	Pmax	Tmax
4	1,0 MPa	+70°C

700EV

 **NOWOŚĆ**
PERFEKT^{SYSTEM}

PERFEKT SYSTEM
Rura pert/evoh/pert



indeks	wielkość	pakowanie [mb]		cena netto [zł]
		krag	paleta	
60-300-1600-600	16 x 2,0	600	2400	3,70
60-300-1720-500	17 x 2,0	500		3,70
60-300-1820-600	18 x 2,0			

G GRUPA RABATOWA

dostępne w II kwartale 2024
dostępne w III kwartale 2024

700PER

PERFEKT^{SYSTEM}

PERFEKT SYSTEM
Rura pert/al./pert



indeks	wielkość	pakowanie [mb]		cena netto [zł]
		krag	paleta	
60-200-1620-200	16 x 2,0	200	4000	5,65
60-200-1620-500	16 x 2,0	500	4000	5,65
60-200-1820-200	18 x 2,0	200		
60-200-2000-100	20 x 2,0	100	2000	7,59
60-200-2500-050	25 x 2,5	50	1000	12,81
60-200-3200-025	32 x 3,0	25	600	21,53
60-200-4040-005	40 x 4,0	5	25	58,33
60-200-5045-005	50 x 4,5	5	15	87,50
60-200-6360-005	63 x 6,0	5	15	141,67

G GRUPA RABATOWA

700PER-IZO

PERFEKT^{SYSTEM}

PERFEKT SYSTEM
Rura pert/al./pert w otulinie polietylenowej



indeks	wielkość	otulina [mm]	kolor otuliny	pakowanie [mb]		cena netto [zł]
				krag	paleta	
60-200-1623-100	16 x 2,0	9	niebieska	100	1400	7,37
60-200-1624-100	16 x 2,0	9	czerwona	100	1400	7,37
60-200-2001-050	20 x 2,0	9	niebieska	50	750	10,61
60-200-2002-050	20 x 2,0	9	czerwona	50	750	10,61
60-200-2501-025	25 x 2,5	9	niebieska	25	450	16,87
60-200-2502-025	25 x 2,5	9	czerwona	25	450	16,87
60-200-3201-025	32 x 3,0	9	niebieska	25	450	27,16
60-200-3202-025	32 x 3,0	9	czerwona	25	450	27,16

G GRUPA RABATOWA

700PE

PERFEKT^{SYSTEM}

PERFEKT SYSTEM
Rura pex/al./pe



indeks	wielkość	pakowanie [mb]		cena netto [zł]
		krag	paleta	
60-100-1610-100	16 x 2,0	100	4000	5,35
60-100-1620-200	16 x 2,0	200	4000	5,35
60-100-1620-500	16 x 2,0	500	4000	5,35
60-100-2000-100	20 x 2,0	100	1800	6,89
60-100-2500-050	25 x 2,5	50	1000	11,06
60-100-3200-025	32 x 3,0	25	600	17,95

G GRUPA RABATOWA

700PE
w odcinkach 5mPERFEKT^{SYSTEM}

PERFEKT SYSTEM
Rura pex/al./pe



indeks	wielkość	pakowanie [mb]		cena netto [zł]
		odcinki	paleta	
60-100-1620-005	16 x 2,0	5	300	5,35
60-100-2000-005	20 x 2,0	5	225	6,94
60-100-2500-005	25 x 2,5	5	125	11,39
60-100-3200-005	32 x 3,0	5	75	17,95

G GRUPA RABATOWA

901

PERFEKT SYSTEM PLUS
Nypel zaprasowywany GZ

G GRUPA RABATOWA

*) dostępny w III kwartale 2024

PERFEKT_{SYSTEM}

indeks	wielkość	PN	Tmax	pakowanie		cena netto [zł]
62-901-1615-000	16 x 1/2"	10	+90°C	5	280	17,36
62-901-1620-000	16 x 3/4"	10	+90°C	5	200	22,40
62-901-1815-000	18 x 1/2"	10	+90°C	5	200	19,60
62-901-1820-000	18 x 3/4"	10	+90°C	5	200	23,90
62-901-2015-000	20 x 1/2"	10	+90°C	5	200	24,89
62-901-2020-000	20 x 3/4"	10	+90°C	5	200	22,95
62-901-2025-000	20 x 1"	10	+90°C	5	160	35,10
62-901-2515-000	25 x 1/2"	10	+90°C	5	120	41,30
62-901-2520-000	25 x 3/4"	10	+90°C	5	120	46,35
62-901-2525-000	25 x 1"	10	+90°C	6	144	42,97
62-901-3225-000	32 x 1"	10	+90°C	5	120	69,60
62-901-3232-000	32 x 1 1/4"	10	+90°C	5	90	78,95
62-901-4032-000	40 x 1 1/4"	10	+90°C	1	60	110,53
62-901-4040-000	40 x 1 1/2"	10	+90°C	1	56	131,58
62-901-5040-000	50 x 1 1/2"	10	+90°C	1	48	144,74
62-901-5050-000	50 x 2"	10	+90°C	1	30	178,95
62-901-6340-000	63 x 1 1/2"	10	+90°C	1	20	300,00
62-901-6350-000	63 x 2"	10	+90°C	1	20	302,63

902

PERFEKT SYSTEM PLUS
Mufa zaprasowywana GW

G GRUPA RABATOWA

*) dostępny w III kwartale 2024

PERFEKT_{SYSTEM}

indeks	wielkość	PN	Tmax	pakowanie		cena netto [zł]
62-902-1615-000	16 x 1/2"	10	+90°C	3	240	21,38
62-902-1620-000	16 x 3/4"	10	+90°C	5	160	26,95
62-902-1815-000	18 x 1/2"	10	+90°C	3	240	24,00
62-902-1820-000	18 x 3/4"	10	+90°C	5	160	27,50
62-902-2015-000	20 x 1/2"	10	+90°C	3	240	23,43
62-902-2020-000	20 x 3/4"	10	+90°C	5	160	26,40
62-902-2520-000	25 x 3/4"	10	+90°C	5	120	36,40
62-902-2525-000	25 x 1"	10	+90°C	5	135	49,12
62-902-3225-000	32 x 1"	10	+90°C	5	135	74,00
62-902-4032-000	40 x 1 1/4"	10	+90°C	1	63	115,79
62-902-4040-000	40 x 1 1/2"	10	+90°C	1	48	118,42
62-902-5040-000	50 x 1 1/2"	10	+90°C	1	48	142,11
62-902-6350-000	63 x 2"	10	+90°C	1	20	284,21

902/O

PERFEKT SYSTEM PLUS
Półśrubunek
zaprasowywany GW

G GRUPA RABATOWA

*) dostępny w III kwartale 2024

PERFEKT_{SYSTEM}

indeks	wielkość	PN	Tmax	pakowanie		cena netto [zł]
62-902-1615-001	16 x 1/2"	10	+90°C	5	240	32,80
62-902-1820-001	18 x 3/4"	10	+90°C	4	220	33,00
62-902-2015-001	20 x 1/2"	10	+90°C	5	240	39,47
62-902-2020-001	20 x 3/4"	10	+90°C	5	160	46,55

903

PERFEKT SYSTEM PLUS
 Złączka zaprasowywana

GRUPA RABATOWA

*) dostępny w III kwartale 2024

PERFEKT^{SYSTEM}+

indeks	wielkość	PN	Tmax	pakowanie		cena netto [zł]
62-903-0160-000	16	10	+90°C	5	240	16,61
62-903-0180-000	18	10	+90°C	5	200	16,80
62-903-0200-000	20	10	+90°C	5	200	20,82
62-903-0250-000	25	10	+90°C	5	120	38,13
62-903-0320-000	32	10	+90°C	5	100	69,58
62-903-0400-000	40	10	+90°C	1	42	113,16
62-903-0500-000	50	10	+90°C	1	33	167,11
62-903-0630-000	63	10	+90°C	1	15	344,74
62-903-1816-000	18 x 16	10	+90°C	5	200	16,80
62-903-2016-000	20 x 16	10	+90°C	5	200	19,95
62-903-2018-000	20 x 18	10	+90°C	5	200	22,00
62-903-2516-000	25 x 16	10	+90°C	5	120	31,05
62-903-2518-000	25 x 18	10	+90°C			27,82
62-903-2520-000	25 x 20	10	+90°C	5	120	43,70
62-903-3216-000	32 x 16	10	+90°C	5	120	43,93
62-903-3218-000	32 x 18	10	+90°C			42,31
62-903-3220-000	32 x 20	10	+90°C	5	80	47,37
62-903-3225-000	32 x 25	10	+90°C	1	100	56,50
62-903-4025-000	40 x 25	10	+90°C	1	42	107,89
62-903-4032-000	40 x 32	10	+90°C	1	42	115,79
62-903-5032-000	50 x 32	10	+90°C	1	40	118,42
62-903-5040-000	50 x 40	10	+90°C	1	40	144,74
62-903-6340-000	63 x 40	10	+90°C	1	18	244,74
62-903-6350-000	63 x 50	10	+90°C	1	18	300,00

904

PERFEKT SYSTEM PLUS
 Kolano zaprasowywane GZ

GRUPA RABATOWA

*) dostępny w III kwartale 2024

PERFEKT^{SYSTEM}+

indeks	wielkość	PN	Tmax	pakowanie		cena netto [zł]
62-904-1615-000	16 x 1/2"	10	+90°C	5	200	25,76
62-904-1620-000	16 x 3/4"	10	+90°C	5	120	35,80
62-904-1815-000	18 x 1/2"	10	+90°C			28,50
62-904-2015-000	20 x 1/2"	10	+90°C	2	190	30,45
62-904-2020-000	20 x 3/4"	10	+90°C	2	160	37,60
62-904-2520-000	25 x 3/4"	10	+90°C	5	80	47,88
62-904-2525-000	25 x 1"	10	+90°C	5	80	57,24
62-904-3225-000	32 x 1"	10	+90°C	2	80	89,90

905

PERFEKT SYSTEM PLUS
 Kolano zaprasowywane GW

GRUPA RABATOWA

*) dostępny w III kwartale 2024

PERFEKT^{SYSTEM}+

indeks	wielkość	PN	Tmax	pakowanie		cena netto [zł]
62-905-1615-000	16 x 1/2"	10	+90°C	5	200	23,56
62-905-2015-000	20 x 1/2"	10	+90°C	6	180	31,26
62-905-2020-000	20 x 3/4"	10	+90°C	6	144	37,00
62-905-2520-000	25 x 3/4"	10	+90°C	6	120	50,68
62-905-2525-000	25 x 1"	10	+90°C			60,23
62-905-3225-000	32 x 1"	10	+90°C	2	72	81,47

906

PERFEKT SYSTEM PLUS
 Kolano zaprasowywane

GRUPA RABATOWA

PERFEKT^{SYSTEM}+

indeks	wielkość	PN	Tmax	pakowanie		cena netto [zł]
62-906-0160-000	16	10	+90°C	5	160	23,40
62-906-0180-000	18	10	+90°C	8	160	24,00
62-906-0200-000	20	10	+90°C	8	160	31,36
62-906-0250-000	25	10	+90°C	4	80	47,28
62-906-0320-000	32	10	+90°C	2	72	84,97
62-906-0400-000	40	10	+90°C	2	30	139,47
62-906-0500-000	50	10	+90°C	1	24	205,26
62-906-0630-000	63	10	+90°C	1	10	381,58

907

PERFEKT SYSTEM PLUS
 Złączka ślepiąca

GRUPA RABATOWA

PERFEKT SYSTEM₊

indeks	wielkość	PN	Tmax	pakowanie		cena netto [zł]
62-907-0160-000	16 x 1/2"	10	+90°C	20	480	9,80
62-907-0200-000	20 x 3/4"	10	+90°C	20	320	14,70

908

PERFEKT SYSTEM PLUS
 Kolano zaprasowywane z mocowaniem

GRUPA RABATOWA

*) dostępny w III kwartale 2024

PERFEKT SYSTEM₊

indeks	wielkość	PN	Tmax	pakowanie		cena netto [zł]
62-908-1615-000	16 x 1/2"	10	+90°C	7	168	33,78
62-908-1815-000	18 x 1/2"	10	+90°C	5	80	35,15
62-908-2015-000	20 x 1/2"	10	+90°C	5	80	40,85

909

PERFEKT SYSTEM PLUS
 Trójnik zaprasowywany

GRUPA RABATOWA

*) dostępny w III kwartale 2024

PERFEKT SYSTEM₊

indeks	wielkość	PN	Tmax	pakowanie		cena netto [zł]
62-909-0160-000	16	10	+90°C	4	144	30,63
62-909-0180-000	18	10	+90°C	2	100	34,50
62-909-0200-000	20	10	+90°C	2	100	39,91
62-909-0250-000	25	10	+90°C	2	48	71,48
62-909-0320-000	32	10	+90°C	4	32	106,00
62-909-0400-000	40	10	+90°C	1	18	202,63
62-909-0500-000	50	10	+90°C	1	12	310,53
62-909-0630-000	63	10	+90°C	1	6	631,58

910

PERFEKT SYSTEM PLUS
 Trójnik zaprasowywany

GRUPA RABATOWA

*) dostępny w III kwartale 2024

PERFEKT SYSTEM₊

indeks	wielkość	PN	Tmax	pakowanie		cena netto [zł]
62-910-1620-000	16 x 20 x 16	10	+90°C	5	120	38,82
62-910-1816-000	18 x 16 x 16	10	+90°C	5	120	36,80
62-910-1816-180	18 x 16 x 18	10	+90°C	5	120	37,80
62-910-2016-000	20 x 16 x 16	10	+90°C	5	120	38,97
62-910-2016-200	20 x 16 x 20	10	+90°C			38,67
62-910-2018-200	20 x 18 x 20	10	+90°C	5	120	36,10
62-910-2020-000	20 x 20 x 16	10	+90°C	5	100	38,35
62-910-2516-200	25 x 16 x 20	10	+90°C	4	64	56,29
62-910-2516-250	25 x 16 x 25	10	+90°C			64,40
62-910-2518-250	25 x 18 x 25	10	+90°C	4	80	49,80
62-910-2520-200	25 x 20 x 20	10	+90°C	4	64	67,70
62-910-2520-250	25 x 20 x 25	10	+90°C	1	64	59,30
62-910-2525-200	25 x 25 x 20	10	+90°C			69,56
62-910-2532-250	25 x 32 x 25	10	+90°C	5	40	88,90
62-910-3216-320	32 x 16 x 32	10	+90°C	4	48	84,20
62-910-3220-320	32 x 20 x 32	10	+90°C	5	40	100,00
62-910-3225-320	32 x 25 x 32	10	+90°C	2	40	111,10
62-910-4020-400	40 x 20 x 40	10	+90°C	1	21	178,95
62-910-4025-400	40 x 25 x 40	10	+90°C	1	21	181,58
62-910-4032-320	40 x 32 x 32	10	+90°C	1	21	186,84
62-910-4032-400	40 x 32 x 40	10	+90°C	1	21	189,47
62-910-5025-500	50 x 25 x 50	10	+90°C	1	11	271,05
62-910-5032-500	50 x 32 x 50	10	+90°C	1	10	273,68
62-910-5040-500	50 x 40 x 50	10	+90°C	1	10	310,53
62-910-6340-630	63 x 40 x 63	10	+90°C	1	7	547,37
62-910-6350-630	63 x 50 x 63	10	+90°C	1	7	578,95

911

PERFEKT SYSTEM PLUS
 Trójnik zaprasowywany GZ

GRUPA RABATOWA

PERFEKT_{SYSTEM}

indeks	wielkość	PN	Tmax	pakowanie		cena netto [zł]
62-911-1615-000	16 x 1/2"	10	+90°C	5	120	39,78
62-911-2015-000	20 x 1/2"	10	+90°C	5	80	47,57
62-911-2020-000	20 x 3/4"	10	+90°C	5	80	58,85
62-911-2520-000	25 x 3/4"	10	+90°C	1	64	71,75
62-911-3225-000	32 x 1"	10	+90°C	1	40	126,40

912

PERFEKT SYSTEM PLUS
 Trójnik zaprasowywany GW

GRUPA RABATOWA

PERFEKT_{SYSTEM}

indeks	wielkość	PN	Tmax	pakowanie		cena netto [zł]
62-912-1615-000	16 x 1/2"	10	+90°C	5	120	37,36
62-912-2015-000	20 x 1/2"	10	+90°C	5	120	47,80
62-912-2020-000	20 x 3/4"	10	+90°C	5	80	53,24
62-912-2515-000	25 x 1/2"	10	+90°C	1	72	69,85
62-912-2520-000	25 x 3/4"	10	+90°C	1	64	83,48
62-912-2525-000	25 x 1"	10	+90°C	1	54	91,75
62-912-3225-000	32 x 1"	10	+90°C	3	48	125,50
62-912-4032-000	40 x 1 1/4"	10	+90°C	1	24	207,89
62-912-5040-000	50 x 1 1/2"			1	18	342,11

913

PERFEKT SYSTEM PLUS
 Listwa do baterii

GRUPA RABATOWA

PERFEKT_{SYSTEM}

indeks	wielkość	PN	Tmax		pakowanie		cena netto [zł]
62-913-0100-000	16 x 1/2" / 100	10	+90°C	III kw.*	1	15	91,95
62-913-0150-000	16 x 1/2" / 150	10	+90°C		1	15	96,21

*) dostępny w III kwartale 2024

746

PERFEKT SYSTEM
 Korek zaprasowywany GZ

GRUPA RABATOWA

PERFEKT_{SYSTEM}

indeks	wielkość	PN	Tmax	pakowanie		cena netto [zł]
62-746-0160-000	16 x 2,0	10	+90°C	10		7,00
62-746-0200-000	20 x 2,0	10	+90°C	10		10,50

731

PERFEKT SYSTEM
 Nypel zaprasowywany GZ

GRUPA RABATOWA

PERFEKT_{SYSTEM}

indeks	wielkość	PN	Tmax	pakowanie		cena netto [zł]
62-731-1615-000	16 x 1/2"	10	+90°C	10	700	15,42
62-731-1620-000	16 x 3/4"	10	+90°C	10	600	19,08
62-731-2015-000	20 x 1/2"	10	+90°C	5	600	19,91
62-731-2020-000	20 x 3/4"	10	+90°C	5	500	20,39
62-731-2515-000	25 x 1/2"	10	+90°C	2	140	35,11
62-731-2520-000	25 x 3/4"	10	+90°C	2	500	41,24
62-731-2525-000	25 x 1"	10	+90°C	2	250	38,19
62-731-3225-000	32 x 1"	10	+90°C	1	150	61,87

732

PERFEKT SYSTEM

Mufa zaprasowywana GW



GRUPA RABATOWA

PERFEKT^QSYSTEM

indeks	wielkość	PN	Tmax	pakowanie	cena netto [zł]
62-732-1615-000	16 x 1/2"	10	+90°C	10 600	18,99
62-732-1620-000	16 x 3/4"	10	+90°C	5 500	22,94
62-732-2015-000	20 x 1/2"	10	+90°C	5 500	20,81
62-732-2020-000	20 x 3/4"	10	+90°C	5 450	22,91
62-732-2520-000	25 x 3/4"	10	+90°C	2 150	31,95
62-732-2525-000	25 x 1"	10	+90°C	2 250	43,65
62-732-3225-000	32 x 1"	10	+90°C	1 150	64,20

733

PERFEKT SYSTEM

Złączka zaprasowywana prosta



GRUPA RABATOWA

PERFEKT^QSYSTEM

indeks	wielkość	PN	Tmax	pakowanie	cena netto [zł]
62-733-0160-000	16	10	+90°C	10 220	14,75
62-733-0200-000	20	10	+90°C	5 400	18,49
62-733-0250-000	25	10	+90°C	5 500	32,10
62-733-0320-000	32	10	+90°C	2 250	59,22
62-733-2016-000	20 x 16	10	+90°C	2 400	17,75
62-733-2516-000	25 x 16	10	+90°C	2 160	26,42
62-733-2520-000	25 x 20	10	+90°C	1 150	37,99
62-733-3225-000	32 x 25	10	+90°C	1 150	50,06

734

PERFEKT SYSTEM

Kolano zaprasowywane GZ



GRUPA RABATOWA

PERFEKT^QSYSTEM

indeks	wielkość	PN	Tmax	pakowanie	cena netto [zł]
62-734-1615-000	16 x 1/2"	10	+90°C	10 500	22,90
62-734-1620-000	16 x 3/4"	10	+90°C	10 350	30,92
62-734-2015-000	20 x 1/2"	10	+90°C	5 350	26,46
62-734-2020-000	20 x 3/4"	10	+90°C	5 280	33,33
62-734-2520-000	25 x 3/4"	10	+90°C	2 150	45,05
62-734-2525-000	25 x 1"	10	+90°C	2 200	47,72
62-734-3225-000	32 x 1"	10	+90°C	1 100	79,62

735

PERFEKT SYSTEM

Kolano zaprasowywane GW



GRUPA RABATOWA

PERFEKT^QSYSTEM

indeks	wielkość	PN	Tmax	pakowanie	cena netto [zł]
62-735-1615-000	16 x 1/2"	10	+90°C	10 400	20,94
62-735-2015-000	20 x 1/2"	10	+90°C	5 300	27,78
62-735-2020-000	20 x 3/4"	10	+90°C	5 260	32,70
62-735-2520-000	25 x 3/4"	10	+90°C	2 180	41,64
62-735-2525-000	25 x 1"	10	+90°C	2 150	54,83
62-735-3225-000	32 x 1"	10	+90°C	1 100	68,61

736

PERFEKT SYSTEM

Kolano zaprasowywane



GRUPA RABATOWA

PERFEKT^QSYSTEM

indeks	wielkość	PN	Tmax	pakowanie	cena netto [zł]
62-736-0160-000	16	10	+90°C	10 600	20,84
62-736-0200-000	20	10	+90°C	5 300	27,86
62-736-0250-000	25	10	+90°C	2 150	42,03
62-736-0320-000	32	10	+90°C	1 100	72,32

738

PERFEKT SYSTEM

Kolano zaprasowywane z mocowaniem



GRUPA RABATOWA

PERFEKT^QSYSTEM

indeks	wielkość	PN	Tmax	pakowanie	cena netto [zł]
62-738-1615-000	16 x 1/2"	10	+90°C	10 240	30,02
62-738-2015-000	20 x 1/2"	10	+90°C	5 220	36,32

739

PERFEKT SYSTEM

Trójnik zaprasowywany GZ



indeks	wielkość	PN	Tmax	pakowanie	cena netto [zł]
62-739-1615-000	16 x 1/2"	10	+90°C	10 300	33,85
62-739-2015-000	20 x 1/2"	10	+90°C	5 250	40,48
62-739-2020-000	20 x 3/4"	10	+90°C	5 200	50,09
62-739-2520-000	25 x 3/4"	10	+90°C	2 150	67,47
62-739-2525-000	25 x 1"	10	+90°C	2 100	91,95
62-739-3225-000	32 x 1"	10	+90°C	1 90	107,55



GRUPA RABATOWA



73A

PERFEKT SYSTEM

Trójnik zaprasowywany GW



indeks	wielkość	PN	Tmax	pakowanie	cena netto [zł]
62-071-1615-000	16 x 1/2"	10	+90°C	10 300	31,80
62-071-1620-000	16 x 3/4"	10	+90°C	10 100	32,20
62-071-2015-000	20 x 1/2"	10	+90°C	5 250	40,82
62-071-2020-000	20 x 3/4"	10	+90°C	5 200	44,85
62-071-2520-000	25 x 3/4"	10	+90°C	2 150	70,30
62-071-2525-000	25 x 1"	10	+90°C	2 100	77,26
62-071-3225-000	32 x 1"	10	+90°C	1 90	105,68



GRUPA RABATOWA



73B

PERFEKT SYSTEM

Trójnik zaprasowywany



indeks	wielkość	PN	Tmax	pakowanie	cena netto [zł]
62-73B-0160-000	16	10	+90°C	10 400	27,21
62-73B-0200-000	20	10	+90°C	5 200	35,48
62-73B-0250-000	25	10	+90°C	2 150	60,19
62-73B-0320-000	32	10	+90°C	1 90	89,15



GRUPA RABATOWA



73C

PERFEKT SYSTEM

Trójnik zaprasowywany



indeks	wielkość	PN	Tmax	pakowanie	cena netto [zł]
62-73C-1620-000	16 x 20 x 16	10	+90°C	10 300	34,51
62-73C-2016-000	20 x 16 x 16	10	+90°C	5 250	34,58
62-73C-2016-001	20 x 16 x 20	10	+90°C	5 250	34,37
62-73C-2020-000	20 x 20 x 16	10	+90°C	5 250	34,07
62-73C-2025-000	20 x 25 x 20	10	+90°C	2 160	48,86
62-73C-2516-001	25 x 16 x 20	10	+90°C		34,85
62-73C-2516-000	25 x 16 x 25	10	+90°C	2 150	57,23
62-73C-2520-000	25 x 20 x 25	10	+90°C	2 150	51,56
62-73C-2520-001	25 x 20 x 20	10	+90°C	2 150	58,80
62-73C-2525-000	25 x 25 x 20	10	+90°C	2 150	60,48
62-73C-3216-000	32 x 16 x 32	10	+90°C		64,95
62-73C-3220-000	32 x 20 x 32	10	+90°C	1 90	84,22
62-73C-3225-000	32 x 25 x 32	10	+90°C	1 100	93,79



GRUPA RABATOWA



732/O

PERFEKT SYSTEM

Półśrubunek zaprasowywany



indeks	wielkość	PN	Tmax	pakowanie	cena netto [zł]
62-732-1615-001	16 x 1/2"	10	+90°C	1 300	28,60
62-732-2020-001	20 x 3/4"	10	+90°C	1 250	37,23
62-732-2525-001	25 x 1"	10	+90°C	1 100	48,78



GRUPA RABATOWA



740

PERFEKT SYSTEM

Listwa do baterii



indeks	wielkość	PN	Tmax	pakowanie	cena netto [zł]
62-740-0100-000	16 x 1/2" x L-100	10	+90°C	1 60	73,56
62-740-0150-000	16 x 1/2" x L-150	10	+90°C	1 60	76,98



GRUPA RABATOWA



741

PERFEKT SYSTEM
Listwa z cyrkulacją
do baterii

PERFEKT^QSYSTEM

indeks	wielkość	PN	Tmax	pakowanie		cena netto [zł]
62-741-0100-000	16 x 1/2" x L-100	10	+90°C	1	60	87,50
62-741-0150-000	16 x 1/2" x L-150	10	+90°C	1	50	90,87



GRUPA RABATOWA

742

PERFEKT SYSTEM
Kolanko
zaprasowywane typ L
do grzejnika

PERFEKT^QSYSTEM

indeks	wielkość	PN	Tmax	pakowanie		cena netto [zł]
62-742-1615-000	16 x L-200	10	+90°C	1	100	75,01



GRUPA RABATOWA

745

PERFEKT SYSTEM
Zespół kolan
z mocowaniem z rurką Cu

PERFEKT^QSYSTEM

indeks	wielkość	PN	Tmax	pakowanie		cena netto [zł]
62-745-1615-000	16 x L-200	10	+90°C	1	100	125,15



GRUPA RABATOWA

730

PERFEKT SYSTEM
Tuleja do złączek
zaprasowywanych

PERFEKT^QSYSTEM

indeks	wielkość	PN	Tmax	pakowanie		cena netto [zł]
62-730-0160-000	16	10	+90°C	100	800	1,73
62-730-0200-000	20	10	+90°C	50	400	2,11
62-730-0250-000	25	10	+90°C	50	200	5,08



GRUPA RABATOWA

701

PERFEKT SYSTEM
Nypel skręcany GZ

PERFEKT^QSYSTEM

indeks	wielkość	PN	Tmax	pakowanie		cena netto [zł]
61-001-1615-000	16 x 1/2"	10	+90°C	10	400	8,12
61-001-2015-000	20 x 1/2"	10	+90°C	5	200	15,26
61-001-2020-000	20 x 3/4"	10	+90°C	5	200	15,83
61-001-2520-000	25 x 3/4"	10	+90°C	2	120	28,74
61-001-2525-000	25 x 1"	10	+90°C	2	100	27,63
61-001-3225-000	32 x 1"	10	+90°C	1	50	38,58



GRUPA RABATOWA

701/B

PERFEKT SYSTEM
Nypel skręcany
z wymiową końcówką
do belki rozdzielacza GZ

PERFEKT^QSYSTEM

indeks	wielkość	PN	Tmax	pakowanie		cena netto [zł]
61-001-1615-001	16 x 1/2"	10	+90°C	10	100	10,71



GRUPA RABATOWA

702





PERFEKT SYSTEM
Mufa skręcana GW





PERFEKT^QSYSTEM





indeks	wielkość	PN	Tmax	pakowanie		cena netto [zł]
61-002-1615-000	16 x 1/2"	10	+90°C	10	400	9,29
61-002-2015-000	20 x 1/2"	10	+90°C	5	200	17,88
61-002-2020-000	20 x 3/4"	10	+90°C	5	200	17,60
61-002-2520-000	25 x 3/4"	10	+90°C	2	100	35,48
61-002-2525-000	25 x 1"	10	+90°C	2	120	42,28
61-002-3225-000	32 x 1"	10	+90°C	1	50	44,08













GRUPA RABATOWA





703		PERFEKT ² SYSTEM						
PERFEKT SYSTEM		indeks	wielkość	PN	Tmax	pakowanie		cena netto [zł]
Mufa skręcana								
 GRUPA RABATOWA		61-003-0160-000	16	10	+90°C	10	200	15,08
		61-003-0200-000	20	10	+90°C	5	160	23,95
		61-003-1620-000	16 x 20	10	+90°C	5	100	22,10
		61-003-2520-000	25 x 20	10	+90°C	2	100	35,92





704		PERFEKT ² SYSTEM						
PERFEKT SYSTEM		indeks	wielkość	PN	Tmax	pakowanie		cena netto [zł]
Kolano skręcane GZ								
 GRUPA RABATOWA		61-004-1615-000	16 x 1/2"	10	+90°C	10	200	12,44
		61-004-2015-000	20 x 1/2"	10	+90°C	5	180	19,81
		61-004-2020-000	20 x 3/4"	10	+90°C	5	120	21,10
		61-004-2525-000	25 x 1"	10	+90°C	2	100	37,74
		61-004-3225-000	32 x 1"	10	+90°C	1	50	49,59

705		PERFEKT ² SYSTEM						
PERFEKT SYSTEM		indeks	wielkość	PN	Tmax	pakowanie		cena netto [zł]
Kolano skręcane GW								
 GRUPA RABATOWA		61-005-1615-000	16 x 1/2"	10	+90°C	10	200	14,40
		61-005-2015-000	20 x 1/2"	10	+90°C	5	180	23,20
		61-005-2020-000	20 x 3/4"	10	+90°C	5	120	24,60
		61-005-2525-000	25 x 1"	10	+90°C	2	100	45,46
		61-005-3225-000	32 x 1"	10	+90°C	1	50	58,79

706		PERFEKT ² SYSTEM						
PERFEKT SYSTEM		indeks	wielkość	PN	Tmax	pakowanie		cena netto [zł]
Kolano skręcane								
 GRUPA RABATOWA		61-006-0160-000	16	10	+90°C	10	160	16,98
		61-006-0200-000	20	10	+90°C	5	120	28,85
		61-006-0250-000	25	10	+90°C	2	80	39,89
		61-006-2520-000	25 x 20	10	+90°C	2	100	41,96
		61-006-0320-000	32	10	+90°C	1	50	42,41

707		PERFEKT ² SYSTEM						
PERFEKT SYSTEM		indeks	wielkość	PN	Tmax	pakowanie		cena netto [zł]
Kolano skręcane z mocowaniem GW								
 GRUPA RABATOWA		61-007-1615-000	16 x 1/2"	10	+90°C	10	120	17,60
		61-007-2015-000	20 x 1/2"	10	+90°C	5	80	25,60
		61-007-2020-000	20 x 3/4"	10	+90°C	5	80	40,20

708		PERFEKT ² SYSTEM						
PERFEKT SYSTEM		indeks	wielkość	PN	Tmax	pakowanie		cena netto [zł]
Trójnik skręcany GZ								
 GRUPA RABATOWA		61-008-1615-000	16 x 1/2"	10	+90°C	10	160	19,60
		61-008-2015-000	20 x 1/2"	10	+90°C	5	120	29,03
		61-008-2020-000	20 x 3/4"	10	+90°C	5	120	36,95
		61-008-2520-000	25 x 3/4"	10	+90°C	2	60	58,68
		61-008-2525-000	25 x 1"	10	+90°C	2	50	67,32
		61-008-3225-000	32 x 1"	10	+90°C	1	50	78,50

709		PERFEKT ² SYSTEM						
PERFEKT SYSTEM		indeks	wielkość	PN	Tmax	pakowanie		cena netto [zł]
Trójnik skręcany GW								
 GRUPA RABATOWA		61-009-1615-000	16 x 1/2"	10	+90°C	10	160	22,24
		61-009-2015-000	20 x 1/2"	10	+90°C	5	120	35,80
		61-009-2020-000	20 x 3/4"	10	+90°C	5	80	41,90
		61-009-2520-000	25 x 3/4"	10	+90°C	2	60	64,09
		61-009-2525-000	25 x 1"	10	+90°C	1	50	67,32
		61-009-3225-000	32 x 1"	10	+90°C	2	50	79,01

70A

PERFEKT SYSTEM
Trójnik skręcanyPERFEKT² SYSTEM

indeks	wielkość	PN	Tmax	pakowanie		cena netto [zł]
61-010-0160-000	16	10	+90°C	10	160	22,92
61-010-0200-000	20	10	+90°C	5	80	39,42
61-010-0250-000	25	10	+90°C	2	60	63,26
61-010-0320-000	32	10	+90°C	1	50	79,30
61-010-1616-000	20 x 16 x 16	10	+90°C	5	120	36,47
61-010-1620-000	20 x 16 x 20	10	+90°C	5	100	37,58
61-010-1625-000	25 x 20 x 16	10	+90°C	2	60	54,34
61-010-2520-000	25 x 20 x 25	10	+90°C	2	60	54,11
61-010-3225-000	32 x 25 x 32	10	+90°C	2	50	93,73

G GRUPA RABATOWA

601

Nypel skręcany GZ



indeks	wielkość	PN	Tmax	pakowanie		cena netto [zł]
61-601-1615-000	16 x 1/2"	10	+90°C	10	280	7,92
61-601-2015-000	20 x 1/2"	10	+90°C	5	150	12,68
61-601-2020-000	20 x 3/4"	10	+90°C	5	150	14,99
61-601-2520-000	25 x 3/4"	10	+90°C	dostępne w II kwartale		
61-601-2525-000	25 x 1"	10	+90°C	dostępne w II kwartale		

D GRUPA RABATOWA

602

Mufa skręcana GW



indeks	wielkość	PN	Tmax	pakowanie		cena netto [zł]
61-602-1615-000	16 x 1/2"	10	+90°C	10	200	9,22
61-602-2015-000	20 x 1/2"	10	+90°C	5	150	12,32
61-602-2020-000	20 x 3/4"	10	+90°C	5	150	15,09
61-602-2520-000	25 x 3/4"	10	+90°C	dostępne w II kwartale		
61-602-2525-000	25 x 1"	10	+90°C	dostępne w II kwartale		

D GRUPA RABATOWA

603

Mufa skręcana



indeks	wielkość	PN	Tmax	pakowanie		cena netto [zł]
61-603-0160-000	16	10	+90°C	10	200	14,28
61-603-0200-000	20	10	+90°C	5	150	22,81
61-603-1620-000	20 x 16	10	+90°C	dostępne w II kwartale		

D GRUPA RABATOWA

604

Kolano skręcane GZ



indeks	wielkość	PN	Tmax	pakowanie		cena netto [zł]
61-604-1615-000	16 x 1/2"	10	+90°C	10	200	11,54
61-604-2015-000	20 x 1/2"	10	+90°C	5	150	15,75
61-604-2020-000	20 x 3/4"	10	+90°C	5	120	16,95

D GRUPA RABATOWA

605

Kolano skręcane GW



indeks	wielkość	PN	Tmax	pakowanie		cena netto [zł]
61-605-1615-000	16 x 1/2"	10	+90°C	10	200	12,60
61-605-2015-000	20 x 1/2"	10	+90°C	5	150	16,53
61-605-2020-000	20 x 3/4"	10	+90°C	5	120	18,98

D GRUPA RABATOWA

606

Kolano skręcane



indeks	wielkość	PN	Tmax	pakowanie		cena netto [zł]
61-606-0160-000	16	10	+90°C	10	200	14,90
61-606-0200-000	20	10	+90°C	5	125	21,13
61-606-2525-000	25	10	+90°C	dostępne w II kwartale		

D GRUPA RABATOWA

607

Kolano skręcane
z mocowaniem GW

indeks	wielkość	PN	Tmax	pakowanie	cena netto [zł]
61-607-1615-000	16 x ½"	10	+90°C	10 120	14,53
61-607-2015-000	20 x ½"	10	+90°C	5 100	20,75
61-607-2020-000	20 x ¾"	10	+90°C	dostępne w II kwartale	

D GRUPA RABATOWA

608

Trójnik skręcany GZ



indeks	wielkość	PN	Tmax	pakowanie	cena netto [zł]
61-608-1615-000	16 x ½"	10	+90°C	10 120	19,09
61-608-2015-000	20 x ½"	10	+90°C	dostępne w II kwartale	
61-608-2020-000	20 x ¾"	10	+90°C	dostępne w II kwartale	

D GRUPA RABATOWA

609

Trójnik skręcany GW



indeks	wielkość	PN	Tmax	pakowanie	cena netto [zł]
61-609-1615-000	16 x ½"	10	+90°C	10 120	20,59
61-609-2015-000	20 x ½"	10	+90°C	dostępne w II kwartale	
61-609-2020-000	20 x ¾"	10	+90°C	dostępne w II kwartale	

D GRUPA RABATOWA

60A

Trójnik skręcany



indeks	wielkość	PN	Tmax	pakowanie	cena netto [zł]
61-610-0160-000	16	10	+90°C	10 120	20,92
61-610-0200-000	20	10	+90°C	5 80	32,56
61-610-1620-000	16 x 20 x 16	10	+90°C	dostępne w II kwartale	
61-610-2016-000	20 x 16 x 20	10	+90°C	5 100	28,77
61-610-2520-000	25 x 20 x 25	10	+90°C	dostępne w II kwartale	
61-610-1616-000	20 x 16 x 16	10	+90°C	dostępne w II kwartale	

w ofercie w II kwartale

U-P1

Uszczelka do złązek
zaprasowywanych
i skręcanych

indeks	wielkość	pakowanie	cena netto [zł]
61-999-0160-000	16	1 1	0,37
61-999-0200-000	20	1 1	0,54
61-999-0250-000	25	1 1	1,07
61-999-0320-000	32	1 1	1,07

G GRUPA RABATOWA

PHA-810

Hak podłogowy
pojedynczy

indeks	wielkość	pakowanie	cena netto [zł]
63-800-0810-000	L-77	100 2500	0,49

G GRUPA RABATOWA

PHA-811

Hak podłogowy
pojedynczy

indeks	wielkość	pakowanie	cena netto [zł]
63-800-0811-000	L-100	100 2500	0,52

G GRUPA RABATOWA

PHA-820

Hak podłogowy
podwójny

indeks	wielkość	pakowanie	cena netto [zł]
63-800-0820-000	L-77	100 2500	0,55

G GRUPA RABATOWA

PHA-821Hak podłogowy
podwójny

indeks	wielkość	pakowanie		cena netto [zł]
63-800-0821-000	L-100	100	500	0,58

G GRUPA RABATOWA**PHA-840**Folia izolacyjna
przeciwwilgociowa
do ogrzewania
podłogowego

indeks	długość rolki	pakowanie		cena netto [zł za m ²]
63-800-0840-000	50 m ²	1	1	4,66

G GRUPA RABATOWA**PHA-850**Korek do prób
szczelności

indeks	wielkość	kolor	pakowanie		cena netto [zł]
63-800-0850-000	½"	czerwony	20	800	1,60

G GRUPA RABATOWA**PHA-851**Korek do prób
szczelności

63-800-0851-000	½"	niebieski	20	800	1,60
------------------------	----	-----------	----	-----	-------------

G GRUPA RABATOWA**793**Gradownik do rur
PERFEKT Pex lub Pert

indeks	wielkość	pakowanie		cena netto [zł]
63-800-2160-000	16	1	1	44,13
63-800-2200-000	20	1	1	50,68
63-800-2250-000	25	1	1	65,40
63-800-2320-000	32	1	1	75,21

G GRUPA RABATOWA**N-PRO1**Nożyce profesjonalne do
cięcia rur PERFEKT SYSTEM
Pex lub Pert

indeks	pakowanie		cena netto [zł]
63-800-1014-000	1	1	189,24

G GRUPA RABATOWA**790**Nożyce do cięcia rur
PERFEKT SYSTEM
Pex lub Pert

indeks	pakowanie		cena netto [zł]
63-800-1015-000	1	1	75,70

G GRUPA RABATOWA**791/0**Sprężyna do gięcia rur
PERFEKT SYSTEM
Pex lub Pert, zewnętrzne

indeks	wielkość	pakowanie		cena netto [zł]
63-700-1600-001	16	1	1	43,11
63-700-2000-001	20	1	1	50,96
63-700-2500-001	25	1	1	82,30
63-700-3200-001	32	1	1	113,68

G GRUPA RABATOWA

792/0

Sprężyna do gięcia rur
PERFEKT SYSTEM
Pex lub Pert, wewnętrzne



indeks	wielkość	pakowanie		cena netto [zł]
63-700-1601-001	16	1	1	23,52
63-700-2001-001	20	1	1	35,26
63-700-2501-001	25	1	1	45,06

G GRUPA RABATOWA

RRP

Rozwijak
do rur PERT lub PEX



indeks	ilość rury w kręgu	rodzaj	pakowanie		cena netto [zł]
63-200-0000-000	500m i 600m	większy	1	1	1335,00

X GRUPA RABATOWA

ACO103BT

Zaciskarka
bezprzewodowa
Novopress ACO103
+cęgi 16,20,25 - zestaw



indeks	pakowanie		cena netto [zł]
63-100-0010-001	1	1	7100,00

X GRUPA RABATOWA

Cęgi zaciskowe

Cęgi zaciskowe
do zaciskarki ACO10BT



indeks	wielkość	numer	pakowanie		cena netto [zł]
63-101-0004-160	16	48066-50	1	1	650,00
63-101-0004-200	20	48068-50	1	1	650,00
63-101-0004-250	25	48069-50	1	1	650,00
63-101-0004-320	32	48070-50	1	1	650,00

X GRUPA RABATOWA

82378

Akumulator M12B4 4,0Ah
do zaciskarki ACO103



indeks	pakowanie		cena netto [zł]
63-100-0020-001	1	1	550,00

X GRUPA RABATOWA

Cęgi zaciskowe

Cęgi zaciskowe profil
U do złączek
zaprasowywanych



indeks	wielkość	numer	pakowanie		cena netto [zł]
63-000-0002-160	16	570765	1	1	676,50
63-000-0002-200	20	570775	1	1	676,50
63-000-0002-250	25	570780	1	1	676,50
63-000-0002-320	32	570785	1	1	676,50
63-000-0002-400	40	570790	1	1	
63-000-0002-500	50	570795	1	1	
63-000-0002-630	63	572365	1	1	

X GRUPA RABATOWA

dostępność i warunki
u Przedstawicieli Handlowych

571013

Zaciskarka
bezprzewodowa
Akku-Press



indeks	pakowanie		cena netto [zł]
63-001-0002-000	1	1	6547,20

X GRUPA RABATOWA

578014

Zaciskarka Mini-Press
22V ACC Basic-Pack
R220 L-Boxx



indeks

pakowanie
cena netto [zł]

63-001-0016-000

1 1 **7436,00**

(X) GRUPA RABATOWA

572111

Zaciskarka
przewodowa
Power-Press SE



indeks

pakowanie
cena netto [zł]

63-001-0003-000

1 1 **4092,00**

(X) GRUPA RABATOWA

577010

Zaciskarka
przewodowa
Power-Press



indeks

pakowanie
cena netto [zł]

63-001-0018-000

1 1 **5800,00**

(X) GRUPA RABATOWA

577011

Zaciskarka
przewodowa
Power-Press



indeks

pakowanie
cena netto [zł]

63-001-0004-000

1 1 **5053,40**

(X) GRUPA RABATOWA

574000

Zaciskarka ręczna
Eco-Press



indeks

pakowanie
cena netto [zł]

63-001-0005-000

1 1 **671,55**

(X) GRUPA RABATOWA

571555

Akumulator Li-Ion do
zaciskarki Akku-Press,
14.4 V, 3.0 Ah



indeks

pakowanie
cena netto [zł]

63-001-0008-000

1 1 **1372,80**

(X) GRUPA RABATOWA

Cęgi zaciskowe mini U

Cęgi zaciskowe profil
U do złączek
zaprasowywanych



indeks

wielkość

numer

pakowanie
cena netto [zł]

63-000-0001-160

16

578374

1 1 **686,40**

63-000-0001-200

20

578378

1 1 **686,40**

63-000-0001-250

25

578380

1 1 **686,40**

63-000-0001-320

32

578382

1 1 **800,80**

(X) GRUPA RABATOWA

571014

Zaciskarka
beprzewodowa
Akku-Press ACC



indeks

pakowanie
cena netto [zł]

63-001-0011-000

1 1 **7207,20**

(X) GRUPA RABATOWA

578012Zaciskarka
bezprzewodowa
Mini-Press ACC

indeks

pakowanie
cena
netto [zł]**63-001-0017-000**1 1 **6749,60** GRUPA RABATOWA**578015**Zaciskarka
bezprzewodowa
Mini-Press S 22V ACC

indeks

pakowanie
cena
netto [zł]**63-001-0013-001**1 1 **7436,00** GRUPA RABATOWA**578010**Zaciskarka
bezprzewodowa
Mini-Press 22V ACC

indeks

pakowanie
cena
netto [zł]**63-001-0006-100**1 1 **7436,00** GRUPA RABATOWA**571545**Akumulator Li-Ion
do zaciskarki
Mini-Press 578012,
14,4 V, 1,5 Ah

indeks

pakowanie
cena
netto [zł]**63-001-0008-003**1 1 **972,40** GRUPA RABATOWA**571571**Akumulator Li-Ion
do zaciskarek
Mini-Press 578010 i 578015,
21,6 V, 2,5 Ah

indeks

pakowanie
cena
netto [zł]**63-001-0008-001**1 1 **1601,60** GRUPA RABATOWA**Posiadamy w ofercie narzędzia dostępne w akcjach promocyjnych
- szczegóły dostępne u przedstawicieli handlowych.****JL1303**Klucz do rur ze
szczękami płaskimi

indeks

wielkość

pakowanie
cena
netto [zł]**90-000-0000-089**

1"

1 1 **65,00** GRUPA RABATOWA**Szczypce uniwersalne
-kombinerki**

indeks

wielkość

pakowanie
cena
netto [zł]**90-000-0000-083**

180 mm

1 1 **27,00** GRUPA RABATOWA



Szczypce wydłużone proste

	indeks	wielkość	pakowanie		cena netto [zł]
					
	90-000-0000-085	200 mm	1	1	27,00

GRUPA RABATOWA

JL1306



Klucz do rur typ S

	indeks	wielkość	pakowanie		cena netto [zł]
					
	90-000-0000-090	1"	1	1	65,00

GRUPA RABATOWA

JL1309

Klucz nastawny do rur typu Stillson

	indeks		pakowanie		cena netto [zł]
					
	90-000-0000-093		1	1	70,00

GRUPA RABATOWA

NWDS-01



Nasadka wielostopniowa do śrubunków

	indeks		pakowanie		cena netto [zł]
					
	90-000-0000-207		1	1	60,00

GRUPA RABATOWA

UGF1006-PP



Klucz nastawny

	indeks	wielkość	pakowanie		cena netto [zł]
					
	90-000-0001-078	6"	1	1	37,00
	90-000-0001-079	10"	1	1	65,00

GRUPA RABATOWA

GL9068



Kamera inspekcyjna do rur

	indeks		pakowanie		cena netto [zł]
					
	90-000-0001-080		1	1	850,00

GRUPA RABATOWA

GT4863

Kabel do kamery inspekcyjnej

	indeks	długość	pakowanie		cena netto [zł]
					
	90-000-0001-089	5 m	1	1	400,00

GRUPA RABATOWA

PERFEXIM

CENNIK ARMATURA 2024



PERFEKT² SYSTEM

- **Niezawodne rozwiązanie w branży HVAC**
- **Zgodna z normą EN12735:1 Miedź i stopy miedzi**
- **Europejski producent**
- **Ochrona zdrowia**

RURA MIEDZIANA

72-74

505

Rura miedziana twarda stan R290

 GRUPA RABATOWA

indeks	wielkość	sztangi 5 m [szt / wiązka m]		cena netto [zł]
70-505-1210-030	12 x 1,0	5	750	z dnia
70-505-1510-030	15 x 1,0	5	500	z dnia
70-505-1810-030	18 x 1,0	5	500	z dnia
70-505-2210-030	22 x 1,0	5	500	z dnia
70-505-2810-030	28 x 1,0	5	500	z dnia
70-505-2815-530	28 x 1,5	5	500	z dnia
70-505-3510-030	35 x 1,0	5	5	z dnia
70-505-3515-530	35 x 1,5	5	5	z dnia
70-505-4215-530	42 x 1,5	5	5	z dnia
70-505-5420-030	54 x 2,0	5	5	z dnia

501

Rura miedziana miękka stan R220

 GRUPA RABATOWA

indeks	wielkość	długość [mb]	cena netto [zł]
70-501-1210-030	12 x 1,0	50	z dnia
70-501-1510-030	15 x 1,0	50	z dnia
70-501-1810-030	18 x 1,0	50	z dnia
70-501-2210-030	22 x 1,0	50	z dnia

508

CLIMAPLUS rura miedziana miękka R220, w otulinie m.in. do klimatyzacji, gazów chłodniczych

 GRUPA RABATOWA

indeks	wielkość	grubość otuliny [mm]	długość [mb]	cena netto [zł]
70-508-1408-030	¼" x 0,7	6	25	z dnia
70-508-3808-030	¾" x 0,7	7	25	z dnia
70-508-1208-030	½" x 0,7	9	25	z dnia
70-508-5808-030	⅝" x 0,7	9	25	z dnia
70-508-1408-035	¼" x 0,7	6	50	z dnia
70-508-3808-035	¾" x 0,7	7	50	z dnia
70-508-1208-035	½" x 0,7	9	50	z dnia
70-508-5808-035	⅝" x 0,7	9	50	z dnia

503

CLIMATUB rura miedziana miękka R220, m.in. do klimatyzacji, celów medycznych

 GRUPA RABATOWA

indeks	wielkość	długość [mb]	cena netto [zł/mb]
70-503-0810-030	8 x 1,0	25	z dnia
70-503-1210-030	12 x 1,0	25	z dnia
70-503-1410-030	14 x 1,0	25	z dnia
70-503-1810-030	18 x 1,0	25	z dnia
70-503-2210-030	22 x 1,0	25	z dnia
70-503-1408-030	¼" x 0,8	15	z dnia
70-503-5168-030	⅝" x 0,8	15	z dnia
70-503-3808-030	¾" x 0,8	15	z dnia
70-503-1208-030	½" x 0,8	15	z dnia
70-503-5808-030	⅝" x 0,8	15	z dnia
70-503-5810-030	⅝" x 1,0	15	z dnia
70-503-3408-030	¾" x 0,8	15	z dnia
70-503-3410-030	¾" x 1,0	15	z dnia
70-503-7810-030	⅞" x 1,0	15	z dnia

507

CLIMATUB rura miedzian
twarda R290 m.in.
do klimatyzacji



X GRUPA RABATOWA

indeks	wielkość	długość [mb]		cena netto [zł/mb]
70-507-0810-030	8 x 1.0	5	50	z dnia
70-507-1010-030	10 x 1.0	5	50	z dnia
70-507-1210-030	12 x 1.0	5	50	z dnia
70-507-1510-030	15 x 1.0	5	50	z dnia
70-507-1810-030	18 x 1.0	5	50	z dnia
70-507-2210-030	22 x 1.0	5	50	z dnia
70-507-2810-030	28 x 1.0	5	50	z dnia
70-507-2815-030	28 x 1.5	5	50	z dnia
70-507-3510-030	35 x 1.0	5	50	z dnia
70-507-3515-030	35 x 1.5	5	50	z dnia
70-507-4215-030	42 x 1.5	5	50	z dnia
70-507-5415-030	54 x 1.5	5	50	z dnia
70-507-5420-030	54 x 2.0	5	50	z dnia
70-507-3808-030	¾" x 0.8	5	50	z dnia
70-507-1208-030	½" x 0.8	5	50	z dnia
70-507-5808-030	⅝" x 0.8	5	50	z dnia
70-507-3408-030	¾" x 0.8	5	50	z dnia
70-507-3410-030	¾" x 1.0	5	50	z dnia
70-507-7810-030	⅞" x 1.0	5	50	z dnia
70-507-2510-030	1" x 1.0	5	50	z dnia
70-507-1181-030	1 ⅛" x 1.0	5	50	z dnia
70-507-1381-030	1 ⅜" x 1.25	5	50	z dnia
70-507-1581-030	1 ⅝" x 1.25	5	50	z dnia
70-507-2181-030	2 ⅛" x 1.25	5	50	z dnia
70-507-2186-030	2 ⅛" x 1.65	5	50	z dnia
70-507-2581-030	2 ⅝" x 1.65	5	50	z dnia
70-507-2582-030	2 ⅝" x 2.0	5	50	z dnia
70-507-3181-030	3 ⅛" x 1.65	5	50	z dnia



Ciepło i komfort w domu

PERFEXIM

CENNIK ARMATURA 2024

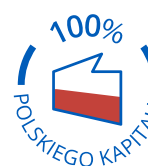

PERFEKT² SYSTEM

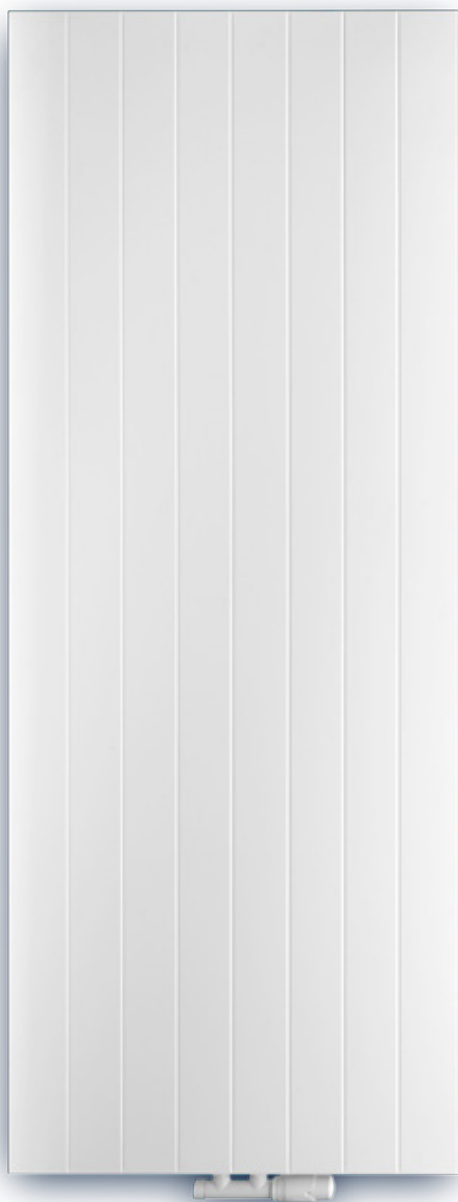

Grzejniki Pionowe **Style Line** powstały z myślą o Klientach ceniących sobie zarówno funkcjonalność jak i nowoczesny design. Poza swoją niezawodną funkcją grzewczą mogą posłużyć również jako modny element wystroju wnętrza, nadając im unikalny charakter. Są dostępne w szerokiej gamie kolorów z palety RAL.

GRZEJNIKI PŁYTOWE I ALUMINIOWE 75-80

Grzejniki płytowe C i V	76
Grzejniki aluminiowe	78
Osprzęt grzejników aluminiowych	78
Główce termostatyczne	78
Osprzęt grzejników stalowych	80

		11C					21C					22C					33C				
wysokość [mm]		300	400	500	600	900	300	400	500	600	900	300	400	500	600	900	300	400	500	600	900
wat/m 70/50/20°C		373	473	569	663	940	543	685	820	950	1313	690	886	1068	1248	1682	951	1209	1453	1685	2301
wykładnik n		1,2842	1,2850	1,2857	1,2865	1,2957	1,2877	1,2914	1,2950	1,2987	1,3250	1,2890	1,2967	1,3045	1,3122	1,3266	1,2999	1,3016	1,3033	1,3050	1,3481
długość [mm]	parametry t ₁ /t ₂ /t ₃																				
400	75/65/20°C	199	252	303	354	502	290	366	438	508	706	368	473	572	669	905	508	646	777	902	1243
	55/45/20°C	103	131	157	183	259	150	189	226	261	359	190	244	294	342	459	262	332	399	463	624
	CENA	307	334	349	413	532	404	459	487	536	650	426	491	514	552	700	674	741	781	800	1128
500	75/65/20°C	248	315	379	442	628	362	457	547	635	882	460	591	715	836	1131	636	808	971	1127	1554
	55/45/20°C	129	163	196	229	324	188	236	283	327	449	238	305	367	428	574	327	416	499	579	781
	CENA	342	366	375	421	562	435	498	534	571	729	461	534	564	591	789	740	816	858	884	1260
600	75/65/20°C	298	378	455	530	753	434	548	657	761	1059	552	710	858	1004	1357	763	970	1166	1352	1865
	55/45/20°C	155	196	236	275	388	225	284	339	392	538	286	366	440	513	689	393	499	599	694	937
	CENA	367	396	408	435	575	461	526	562	603	771	487	571	607	648	864	816	883	914	974	1349
700	75/65/20°C	348	441	531	619	879	507	640	766	888	1235	644	828	1000	1171	1583	890	1131	1360	1578	2176
	55/45/20°C	181	229	275	321	453	263	331	396	458	628	333	427	514	599	804	458	582	699	810	1093
	CENA	396	422	435	454	617	505	575	611	655	857	534	617	652	704	976	890	970	1011	1073	1503
800	75/65/20°C	398	504	606	707	1004	579	731	876	1015	1412	736	946	1143	1338	1810	1017	1293	1554	1803	2486
	55/45/20°C	206	261	314	367	518	300	378	452	523	718	381	488	587	685	919	523	665	799	926	1249
	CENA	422	450	461	472	655	543	617	653	713	930	581	657	689	741	1080	942	1037	1091	1146	1654
900	75/65/20°C	447	567	682	796	1130	652	823	985	1142	1588	828	1065	1286	1506	2036	1144	1454	1749	2029	2797
	55/45/20°C	232	294	354	412	583	338	425	509	588	807	429	549	661	770	1034	589	748	899	1042	1405
	CENA	449	487	494	508	706	595	672	706	770	1021	635	721	755	803	1197	1022	1129	1191	1245	1802
1000	75/65/20°C	497	630	758	884	1255	724	914	1095	1269	1765	920	1183	1429	1673	2262	1271	1616	1943	2254	3108
	55/45/20°C	258	327	393	458	647	375	473	565	654	897	476	610	734	856	1149	654	831	998	1157	1561
	CENA	477	515	535	554	760	626	703	736	785	1107	690	761	774	809	1284	1098	1216	1284	1326	1956
1100	75/65/20°C	547	693	834	972	1381	796	1006	1204	1396	1941	1012	1301	1572	1840	2488	1398	1778	2137	2479	3419
	55/45/20°C	284	360	432	504	712	413	520	622	719	987	524	671	807	941	1264	720	914	1098	1273	1717
	CENA	495	551	582	603	807	667	767	823	884	1188	735	829	861	923	1411	1172	1298	1373	1443	2119
1200	75/65/20°C	596	756	909	1061	1506	869	1097	1314	1523	2118	1104	1419	1715	2007	2714	1525	1939	2332	2705	3730
	55/45/20°C	309	392	472	550	777	450	567	678	784	1076	571	732	881	1027	1378	785	997	1198	1389	1873
	CENA	524	585	617	627	857	704	818	883	946	1274	774	898	952	985	1526	1245	1379	1462	1533	2273
1300	75/65/20°C	646	819	985	1149	1632	941	1188	1423	1650	2294	1196	1538	1858	2175	2941	1652	2101	2526	2930	4040
	55/45/20°C	335	425	511	596	842	488	614	735	850	1166	619	793	954	1112	1493	851	1081	1298	1504	2029
	CENA	541	622	674	694	938	749	868	936	1031	1355	843	1007	1095	1164	1679	1350	1535	1660	1738	2523
1400	75/65/20°C	696	882	1061	1238	1757	1014	1280	1533	1777	2471	1288	1656	2001	2342	3167	1779	2262	2720	3156	4351
	55/45/20°C	361	458	550	641	906	525	662	791	915	1256	667	854	1028	1198	1608	916	1164	1398	1620	2185
	CENA	553	637	700	717	961	771	898	971	1069	1405	877	1041	1128	1216	1710	1389	1577	1703	1773	2580
1600	75/65/20°C	795	1008	1213	1414	2008	1158	1463	1752	2030	2824	1472	1893	2287	2677	3619	2034	2586	3109	3606	4973
	55/45/20°C	413	523	629	733	1036	600	756	904	1046	1435	762	976	1174	1369	1838	1047	1330	1598	1852	2498
	CENA	607	700	761	811	1065	854	996	1078	1180	1565	991	1167	1257	1379	1924	1533	1770	1938	2038	2861
1800	75/65/20°C	895	1134	1364	1591	2259	1303	1645	1971	2284	3177	1656	2129	2573	3011	4072	2288	2909	3497	4057	5594
	55/45/20°C	464	588	707	825	1165	675	851	1017	1177	1615	857	1098	1321	1540	2068	1178	1496	1797	2083	2810
	CENA	659	771	853	901	1178	932	1097	1200	1330	1745	1091	1298	1405	1580	2147	1687	1956	2148	2273	3150
2000	75/65/20°C	994	1260	1516	1768	2510	1448	1828	2190	2538	3530	1840	2366	2858	3346	4524	2542	3232	3886	4508	6216
	55/45/20°C	516	654	786	916	1295	750	945	1130	1307	1794	952	1220	1468	1711	2297	1309	1662	1997	2315	3122
	CENA	716	837	923	976	1339	1011	1203	1323	1456	1894	1187	1437	1577	1713	2325	1819	2123	2346	2533	3410
2200	75/65/20°C	1093	1386	1667	1945	2761	1593	2011	2409	2792	3883	2024	2602	3144	3680	4976	2796	3555	4275	4959	6838
	55/45/20°C	567	719	865	1008	1424	825	1040	1243	1438	1973	1048	1342	1615	1883	2527	1439	1829	2197	2546	3434
	CENA	774	892	976	1108	1472	1088	1290	1415	1612	2181	1330	1610	1763	1894	2661	2020	2336	2561	2886	3769
2400	75/65/20°C	1193	1512	1819	2122	3012	1738	2194	2628	3046	4236	2208	2839	3430	4015	5429	3050	3878	4663	5410	7459
	55/45/20°C	619	784	943	1100	1554	900	1134	1356	1569	2153	1143	1464	1762	2054	2757	1570	1995	2396	2777	3746
	CENA	881	1027	1136	1180	1625	1220	1425	1548	1725	2291	1415	1739	1932	2046	2794	2129	2483	2741	3101	3922
2600	75/65/20°C	1292	1638	1971	2298	3263	1882	2377	2847	3299	4589	2392	3075	3716	4349	5881	3305	4202	5052	5860	8081
	55/45/20°C	671	850	1022	1191	1683	975	1229	1469	1699	2332	1238	1586	1908	2225	2986	1701	2161	2596	3009	4059
	CENA	921	1065	1169	1268	1793	1267	1510	1667	1829	2496	1463	1833	2063	2287	3029	2255	2644	2930	3299	4203
2800	75/65/20°C	1392	1764	2122	2475	3514	2027	2560													

		11V					21V					22V					33V				
wysokość [mm]		300	400	500	600	900	300	400	500	600	900	300	400	500	600	900	300	400	500	600	900
wat/m 70/50/20°C		373	473	569	663	940	543	685	820	950	1313	690	886	1068	1248	1682	951	1209	1453	1685	2301
wykładnik n		1,2842	1,2850	1,2857	1,2865	1,2957	1,2877	1,2914	1,2950	1,2987	1,3250	1,2890	1,2967	1,3045	1,3122	1,3266	1,2999	1,3016	1,3033	1,3050	1,3481
dlugość [mm]	parametry ϵ_r/ϵ_i																				
400	75/65/20°C	199	252	303	354	502	290	366	438	508	706	368	473	572	669	905	508	646	777	902	1243
	55/45/20°C	103	131	157	183	259	150	189	226	261	359	190	244	294	342	459	262	332	399	463	624
	CENA	487	520	532	549	650	601	633	653	694	858	635	677	694	754	909	890	979	1041	1108	1318
500	75/65/20°C	248	315	379	442	628	362	457	547	635	882	460	591	715	836	1131	636	808	971	1127	1554
	55/45/20°C	129	163	196	229	324	188	236	283	327	449	238	305	367	428	574	327	416	499	579	781
	CENA	507	541	554	565	684	648	679	700	734	921	672	716	735	771	991	956	1037	1088	1164	1407
600	75/65/20°C	298	378	455	530	753	434	548	657	761	1059	552	710	858	1004	1357	763	970	1166	1352	1865
	55/45/20°C	155	196	236	275	388	225	284	339	392	538	286	366	440	513	689	393	499	599	694	937
	CENA	528	562	575	584	717	674	711	735	760	956	710	761	785	821	1055	993	1086	1144	1229	1486
700	75/65/20°C	348	441	531	619	879	507	640	766	888	1235	644	828	1000	1171	1583	890	1131	1360	1578	2176
	55/45/20°C	181	229	275	321	453	263	331	396	458	628	333	427	514	599	804	458	582	699	810	1093
	CENA	564	602	613	624	770	714	749	770	843	1048	744	809	839	878	1187	1069	1166	1229	1295	1642
800	75/65/20°C	398	504	606	707	1004	579	731	876	1015	1412	736	946	1143	1338	1810	1017	1293	1554	1803	2486
	55/45/20°C	206	261	314	367	518	300	378	452	523	718	381	488	587	685	919	523	665	799	926	1249
	CENA	617	626	637	650	820	749	789	812	901	1164	771	853	898	936	1300	1141	1221	1267	1354	1793
900	75/65/20°C	447	567	682	796	1130	652	823	985	1142	1588	828	1065	1286	1506	2036	1144	1454	1749	2029	2797
	55/45/20°C	232	294	354	412	583	338	425	509	588	807	429	549	661	770	1034	589	748	899	1042	1405
	CENA	637	662	673	694	878	788	837	869	959	1256	837	911	952	999	1463	1227	1318	1368	1463	1948
1000	75/65/20°C	497	630	758	884	1255	724	914	1095	1269	1765	920	1183	1429	1673	2262	1271	1616	1943	2254	3108
	55/45/20°C	258	327	393	458	647	375	473	565	654	897	476	610	734	856	1149	654	831	998	1157	1561
	CENA	666	696	703	711	930	822	879	914	1003	1350	883	954	991	1022	1558	1299	1401	1463	1561	2097
1100	75/65/20°C	547	693	834	972	1381	796	1006	1204	1396	1941	1012	1301	1572	1840	2488	1398	1778	2137	2479	3419
	55/45/20°C	284	360	432	504	712	413	520	622	719	987	524	671	807	941	1264	720	914	1098	1273	1717
	CENA	690	735	749	766	977	862	942	999	1073	1431	930	1031	1095	1117	1670	1389	1498	1564	1680	2246
1200	75/65/20°C	596	756	909	1061	1506	869	1097	1314	1523	2118	1104	1419	1715	2007	2714	1525	1939	2332	2705	3730
	55/45/20°C	309	392	472	550	777	450	567	678	784	1076	571	732	881	1027	1378	785	997	1198	1389	1873
	CENA	721	769	781	791	1025	908	993	1060	1140	1514	976	1095	1170	1225	1713	1463	1586	1667	1783	2408
1300	75/65/20°C	646	819	985	1149	1632	941	1188	1423	1650	2294	1196	1538	1858	2175	2941	1652	2101	2526	2930	4040
	55/45/20°C	335	425	511	596	842	488	614	735	850	1166	619	793	954	1112	1493	851	1081	1298	1504	2029
	CENA	766	820	839	850	1081	959	1052	1124	1217	1594	1038	1187	1288	1332	1872	1581	1762	1891	2157	2671
1400	75/65/20°C	696	882	1061	1238	1757	1014	1280	1533	1777	2471	1288	1656	2001	2342	3167	1779	2262	2720	3156	4351
	55/45/20°C	361	458	550	641	906	525	662	791	915	1256	667	854	1028	1198	1608	916	1164	1398	1620	2185
	CENA	791	853	873	884	1112	985	1081	1155	1258	1631	1065	1221	1329	1375	1907	1612	1812	1958	2198	2705
1600	75/65/20°C	795	1008	1213	1414	2008	1158	1463	1752	2030	2824	1472	1893	2287	2677	3619	2034	2586	3109	3606	4973
	55/45/20°C	413	523	629	733	1036	600	756	904	1046	1435	762	976	1174	1369	1838	1047	1330	1598	1852	2498
	CENA	861	926	954	992	1208	1071	1180	1267	1389	1811	1157	1360	1507	1568	2129	1769	2006	2185	2428	2982
1800	75/65/20°C	895	1134	1364	1591	2259	1303	1645	1971	2284	3177	1656	2129	2573	3011	4072	2288	2909	3497	4057	5594
	55/45/20°C	464	588	707	825	1165	675	851	1017	1177	1615	857	1098	1321	1540	2068	1178	1496	1797	2083	2810
	CENA	936	1005	1037	1078	1319	1159	1288	1389	1528	1978	1250	1477	1647	1763	2323	1927	2184	2374	2681	3275
2000	75/65/20°C	994	1260	1516	1768	2510	1448	1828	2190	2538	3530	1840	2366	2858	3346	4524	2542	3232	3886	4508	6216
	55/45/20°C	516	654	786	916	1295	750	945	1130	1307	1794	952	1220	1468	1711	2297	1309	1662	1997	2315	3122
	CENA	997	1077	1115	1159	1477	1238	1385	1506	1680	2181	1344	1596	1785	1943	2539	2075	2365	2583	2907	3550
2200	75/65/20°C	1093	1386	1667	1945	2761	1593	2011	2409	2792	3883	2024	2602	3144	3680	4976	2796	3555	4275	4959	6838
	55/45/20°C	567	719	865	1008	1424	825	1040	1243	1438	1973	1048	1342	1615	1883	2527	1439	1829	2197	2546	3434
	CENA	1048	1141	1189	1267	1646	1326	1504	1650	1794	2419	1463	1769	2006	2213	2778	2251	2603	2879	3281	3930
2400	75/65/20°C	1193	1512	1819	2122	3012	1738	2194	2628	3046	4236	2208	2839	3430	4015	5429	3050	3878	4663	5410	7459
	55/45/20°C	619	784	943	1100	1554	900	1134	1356	1569	2153	1143	1464	1762	2054	2757	1570	1995	2396	2777	3746
	CENA	1136	1233	1284	1368	1770	1420	1621	1792	1937	2571	1574	1922	2198	2399	2904	2419	2764	3029	3442	4074
2600	75/65/20°C	1292	1638	1971	2298	3263	1882	2377	2847	3299	4589	2392	3075	3716	4349	5881	3305	4202	5052	5860	8081
	55/45/20°C	671	850	1022	1191	1683	975	1229	1469	1699	2332	1238	1586	1908	2225	2986	1701	2161	2596	3009	4059
	CENA	1180	1297	1360	1403	1912	1478	1696	1878	2052	2745	1630	2028	2346	2532	3137	2523	2912	3215	36	

CO-350**PERFEKT**
grzejnik aluminiowy**PERFEKT**²
SYSTEM

indeks	wielkość	PN	Tmax	pakowanie		cena netto [zł]
71-000-3500-000	350	16	+95°C	10	500	38,55

X GRUPA RABATOWAProdukt dostępny
do wyczerpania zapasów**PHA-042**Zestaw do podłączenia
grzejnika aluminiowego**PERFEKT**²
SYSTEM

indeks	wielkość	PN	Tmax	pakowanie		cena netto [zł]
71-942-0000-000	1" x 1/2"	10	+110°C	1	50	16,48

K GRUPA RABATOWA**NP**Nypel do grzejnika
aluminiowego

indeks	wielkość	PN	Tmax	pakowanie		cena netto [zł]
71-960-0000-002	1"	10	+110°C	1	500	1,68

J GRUPA RABATOWA**UZ**Uszczelka nypla do grzejnika
aluminiowego

indeks	wielkość	pakowanie		cena netto [zł]
71-960-0000-100	1 mm	1	100	0,33
71-960-0000-101	1,5 mm	1	100	0,35

J GRUPA RABATOWA**TRCD10C**Głowica termostatyczna
cieczowa M30x1.5,
chromowana

indeks	Tmax	pakowanie		cena netto [zł]
20-107-0400-000	+50°C	1	100	38,23

E GRUPA RABATOWA**TRCD10**Głowica termostatyczna
cieczowa M30x1.5,
biała

indeks	kolor	Tmax	pakowanie		cena netto [zł]
20-107-0400-100	biały	+50°C	1	100	39,74
20-107-0400-003	czarny mat	+50°C	1	100	37,49

E GRUPA RABATOWA

TRCD15

Głowica termostatyczna cieczowa M30x1.5 z blokadą nastawy



indeks

Tmax

pakowanie

cena netto [zł]

20-107-0300-000

+50°C

1 100

33,46**E** GRUPA RABATOWA**GS.07**

Głowica termostatyczna cieczowa z przyłączem RA-N do grzejników stalowych typ V

**PERFEKT²** SYSTEM

indeks

pakowanie

cena netto [zł]

20-300-0005-000

1 100

68,89**H** GRUPA RABATOWA**GT01RA**

Głowica termostatyczna cieczowa z przyłączem RA z blokadą nastawy temperatury

**▶ NOWOŚĆ**

indeks

Tmax

pakowanie

cena netto [zł]

20-300-0009-000

+50°C

1 100

E GRUPA RABATOWA

dostępne w III kwartale 2024

**GT02RA**

Głowica termostatyczna cieczowa z przyłączem RA

**▶ NOWOŚĆ**

indeks

Tmax

pakowanie

cena netto [zł]

20-300-0010-000

+50°C

1 100

E GRUPA RABATOWA

dostępne w III kwartale 2024

**GT01**

Głowica termostatyczna cieczowa M30x1.5 z blokadą nastawy

**▶ NOWOŚĆ**

indeks

Tmax

pakowanie

cena netto [zł]

20-107-0300-003

+50°C

1 100

25,30**E** GRUPA RABATOWA

dostępne w III kwartale 2024

**GT03**

Głowica termostatyczna cieczowa M30x1.5 z blokadą nastawy

**▶ NOWOŚĆ**

indeks

Tmax

pakowanie

cena netto [zł]

20-107-0300-004

+50°C

1 100

25,30**E** GRUPA RABATOWA

dostępne w III kwartale 2024

**GT04**

Głowica termostatyczna cieczowa M30x1.5 z blokadą nastawy

**▶ NOWOŚĆ**

indeks

Tmax

pakowanie

cena netto [zł]

20-107-0300-005

+50°C

1 100

25,30**E** GRUPA RABATOWA

dostępne w III kwartale 2024



KM

Zestaw montażowy do grzejników stalowych typu C



indeks	pakowanie		cena netto [zł]
81-001-0003-000	1	1	12,24

Z GRUPA RABATOWA**KDZ**

Konsola do zawieszenia grzejników stalowych typu V



indeks	wielkość	pakowanie		cena netto [zł]
81-000-0300-001	300	1	50	37,92
81-000-0400-001	400	1	50	38,59
81-000-0500-001	500	1	50	39,22
81-000-0600-001	600	1	50	40,93
81-000-0900-001	900	1	50	46,68

Z GRUPA RABATOWA**KGH**

Konsola do zawieszenia grzejników stalowych higienicznych



indeks	wielkość	pakowanie		cena netto [zł]
81-000-0300-002	300	1	1	90,32
81-000-0400-002	400	1	1	96,68
81-000-0500-002	500	1	1	100,21
81-000-0600-002	600	1	1	110,79
81-000-0900-002	900	1	1	114,29

H GRUPA RABATOWA**KW**

Konsola wolnostojąca do grzejnika stalowego



indeks	wielkość	pakowanie		cena netto [zł]
81-001-0000-000	300-900	1	1	222,29

Z GRUPA RABATOWA**OK**

Osłona stopy konsoli wolnostojącej



indeks	pakowanie		cena netto [zł]
81-002-0000-000	1	1	11,83

Z GRUPA RABATOWA

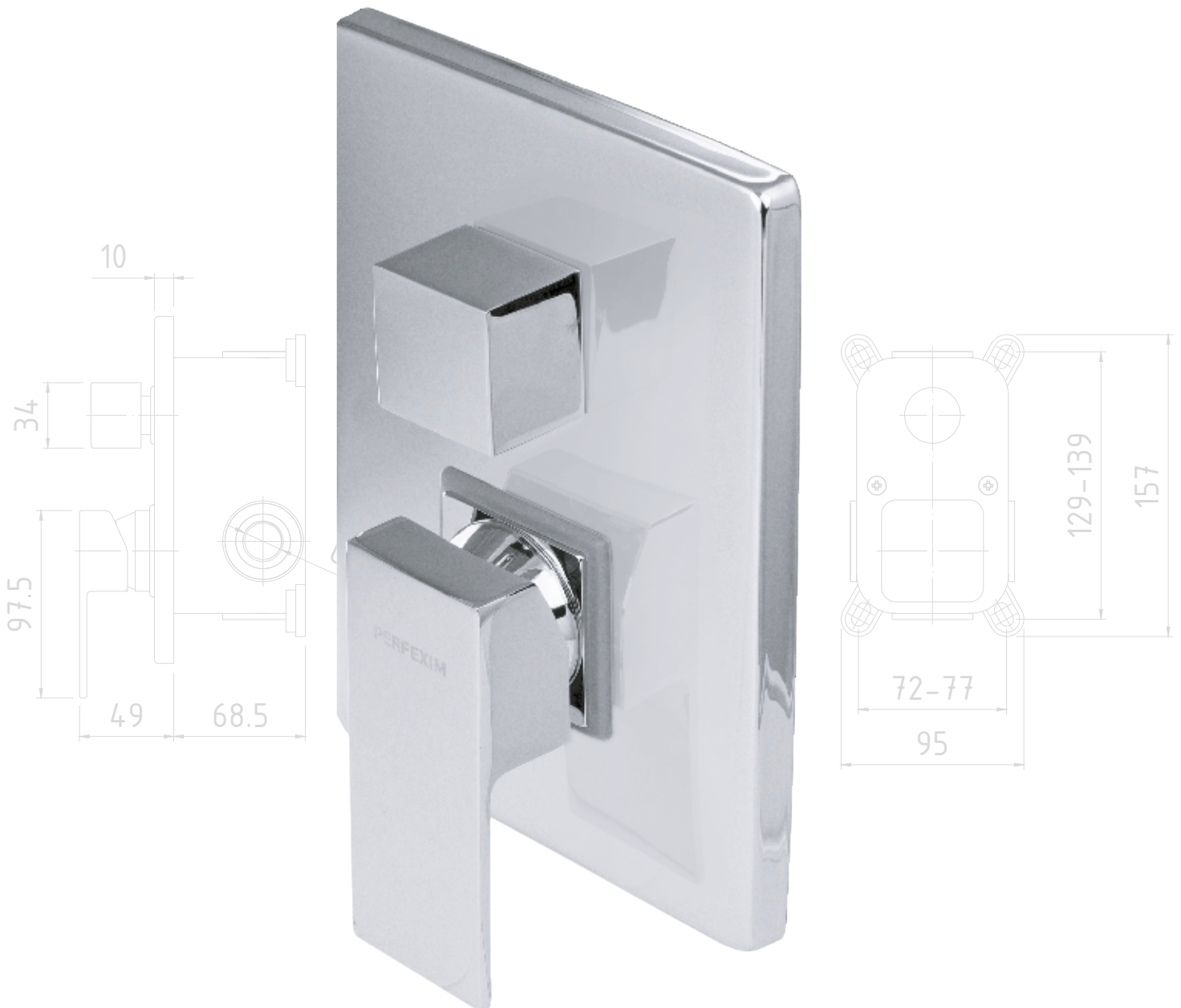

BATERIE PODTYNKOWE 81-88

Baterie podtynkowe	82
Aksesoria do baterii podtynkowych	86

SOP04/1P**SOPHIE**

Bateria prysznicowa podtynkowa, wyposażona w box montażowy

I GRUPA RABATOWA
GŁOWICA 35

indeks	pakow. ☞	cena netto [zł]
35-022-0600-000	1	319,60

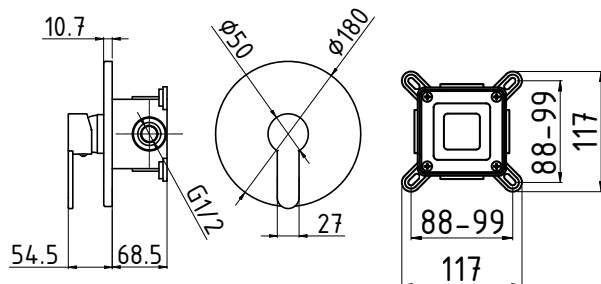
**SOP04/2P****SOPHIE**

Bateria prysznicowa podtynkowa z przełącznikiem prysznic-deszczownia, wyposażona w box montażowy

I GRUPA RABATOWA
GŁOWICA 40

indeks	pakow. ☞	cena netto [zł]
35-022-0600-001	1	514,10

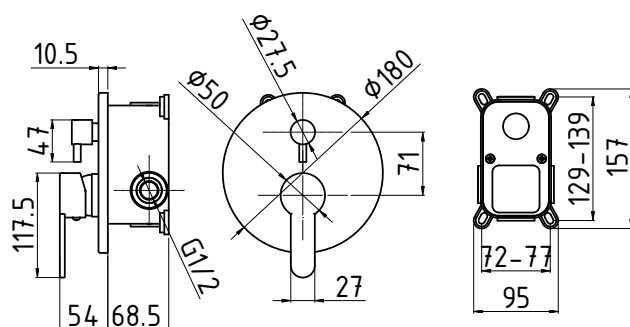

OLI04/1P**OLIVIA**

Bateria prysznicowa podtynkowa, wyposażona w box montażowy

I GRUPA RABATOWA

GŁOWICA 35

indeks	pakow. ☐	cena netto [zł]
35-023-0600-000	1	356,76

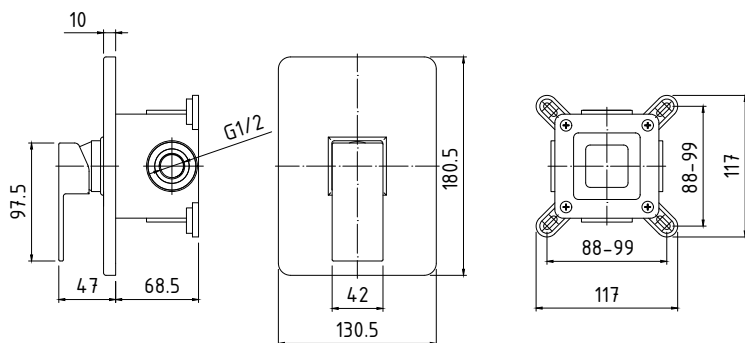
**OLI04/2P****OLIVIA**

Bateria prysznicowa podtynkowa z przełącznikiem prysznic-deszczownia, wyposażona w box montażowy

I GRUPA RABATOWA

GŁOWICA 35

indeks	pakow. ☐	cena netto [zł]
35-023-0600-001	1	547,54

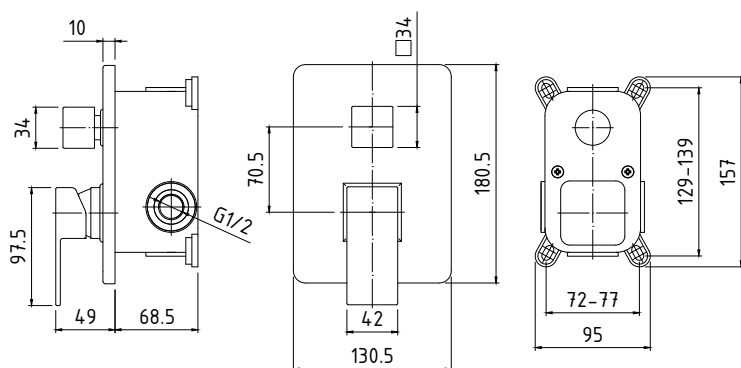

ROS04/2P**ROSALIA**

Bateria prysznicowa podtynkowa z przełącznikiem prysznic-deszczownia, wyposażona w box montażowy

I GRUPA RABATOWA
GŁOWICA 40

indeks	pakow. ☒	cena netto [zł]
35-024-0600-001	1	590,90

**OLI06****OLIVIA**

Bateria umywalkowa podtynkowa, wyl. stała, wyposażona w box montażowy

I GRUPA RABATOWA
GŁOWICA 35

indeks	pakow. ☒	cena netto [zł]
35-025-0200-000	1	542,57

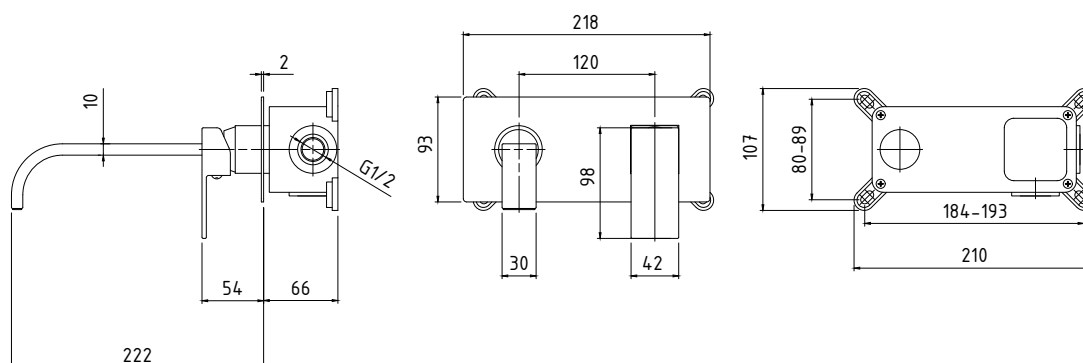

OLI06-1

OLIVIA

Bateria umywalkowa podtynkowa, wyl. stała,



GRUPA RABATOWA
GŁOWICA 35

indeks	pakow.	cena netto [zł]
35-025-0200-001	1	398,89

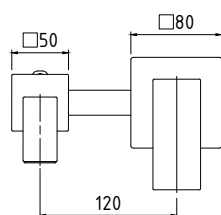
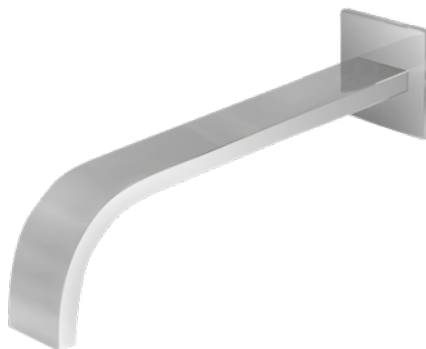
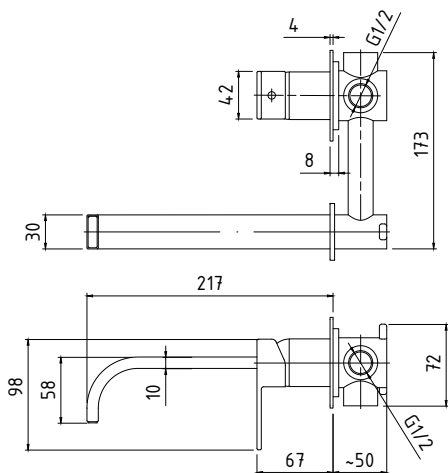

MAR06-1

MARGO

Bateria umywalkowa podtynkowa, wyl. stała



GRUPA RABATOWA
GŁOWICA 35

indeks	pakow.	cena netto [zł]
35-026-0200-001	1	447,19

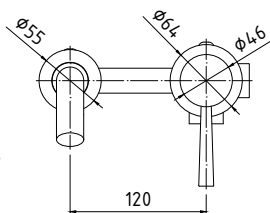
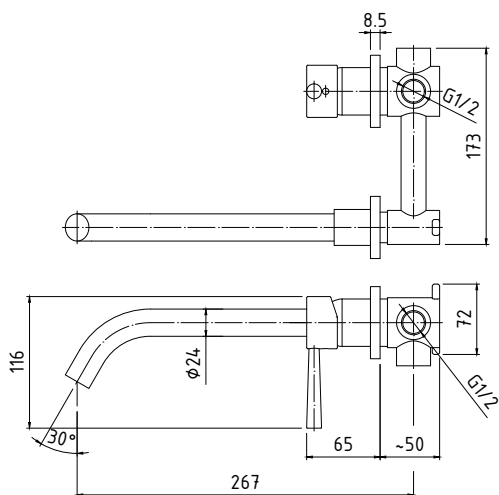

P12

Deszczownia PŁASKA
kwadratowa 300mm x 300mm,
do baterii podtynkowych



I GRUPA RABATOWA

indeks	pakow. ☞	cena netto [zł]
35-202-0002-000	1	192,90

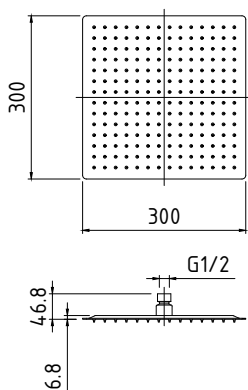
**P13**

Deszczownia PŁASKA
kwadratowa 400mm x 400mm,
do baterii podtynkowych



I GRUPA RABATOWA

indeks	pakow. ☞	cena netto [zł]
35-202-0002-001	1	379,35

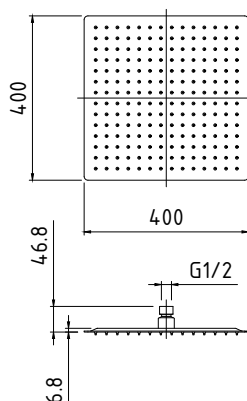
**P14**

Deszczownia PŁASKA okrągła
Ø 300 mm, (12"), do baterii
podtynkowych



I GRUPA RABATOWA

indeks	pakow. ☞	cena netto [zł]
35-202-0001-000	1	167,17

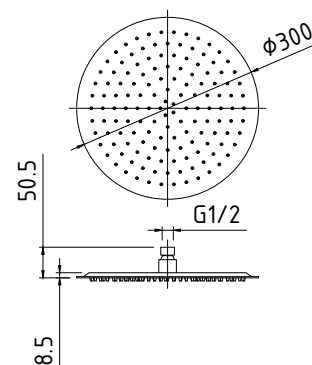
**M1**

Maskownica okrągła Ø 160 mm
PŁASKA do baterii podtynkowych
bez przełącznika (dedykowana
do baterii SOPHIE SOP04/1P)



I GRUPA RABATOWA

indeks	pakow. ☞	cena netto [zł]
35-203-0001-000	1	108,01

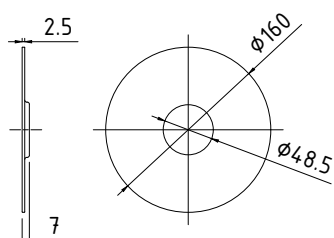
**M2**

Maskownica okrągła Ø 160mm,
PŁASKA, do baterii podtynkowych
z przełącznikiem (dedykowana do
baterii SOPHIE SOP04/2P)



I GRUPA RABATOWA

indeks	pakow. ☞	cena netto [zł]
35-203-0001-001	1	108,01

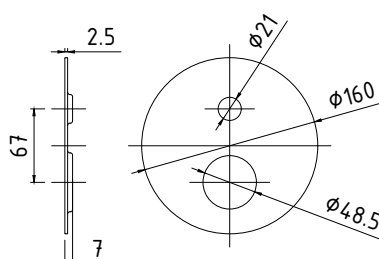
**M3**

Maskownica prostokątna
120mm x 150mm, PŁASKA, do baterii
podtynkowych bez przełącznika
(dedykowana do baterii OLIVIA
OLI04/1P)



I GRUPA RABATOWA

indeks	pakow. ☞	cena netto [zł]
35-203-0000-000	1	102,87

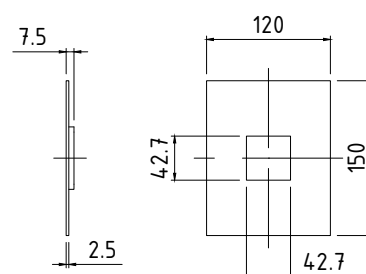
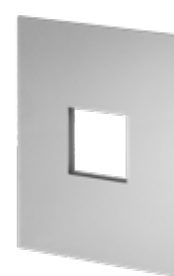

M4

Maskownica prostokątna 120mm x 150mm, PŁASKA, do baterii podtynkowych z przełącznikiem (dedykowana do baterii OLIVIA OLI04/2P)



GRUPA RABATOWA

indeks	pakow.	cena netto [zł]
35-203-0000-001	1	108,01

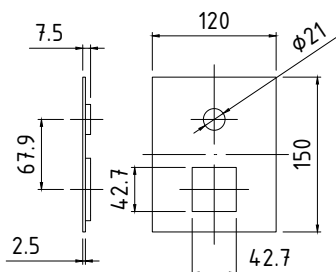

US1

Uchwyt zasilający do słuchawki prysznicowej - okrągły, do baterii podtynkowych



GRUPA RABATOWA

indeks	pakow.	cena netto [zł]
35-208-0001-000	1	92,59

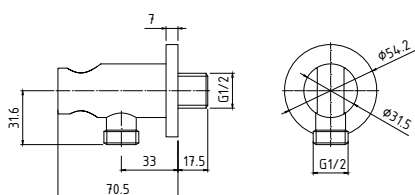

PW01

Przyłącze zasilające do węży prysznicowego okrągłe, do baterii podtynkowych



GRUPA RABATOWA

indeks	pakow.	cena netto [zł]
35-206-0001-000	1	57,87

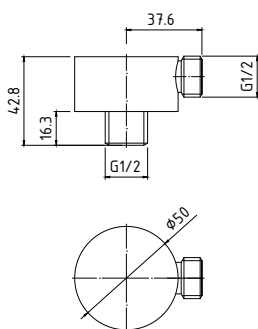

PW02

Przyłącze zasilające do węży prysznicowego kwadrat, do baterii podtynkowych



GRUPA RABATOWA

indeks	pakow.	cena netto [zł]
35-206-0002-000	1	61,72

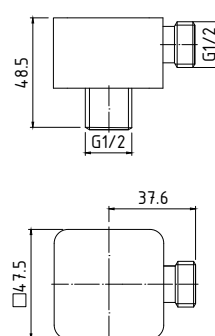

US2

Uchwyt zasilający do słuchawki prysznicowej - prostokątny, do baterii podtynkowych



GRUPA RABATOWA

indeks	pakow.	cena netto [zł]
35-208-0002-000	1	92,59

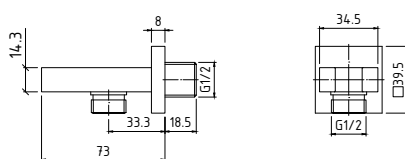

R11

Ramię prysznicowe poziome profil prostokątny 30x15mm, długość 400mm, do baterii podtynkowych



GRUPA RABATOWA

indeks	pakow.	cena netto [zł]
35-207-0003-000	1	120,88

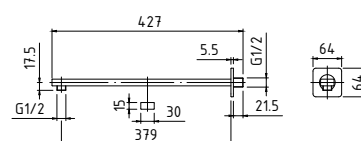

R12

Ramię prysznicowe poziome
profil prostokątny 30x15mm,
długość 500mm, do baterii
podtynkowych



I GRUPA RABATOWA

indeks	pakow. ☐	cena netto [zł]
35-207-0003-001	1	160,75

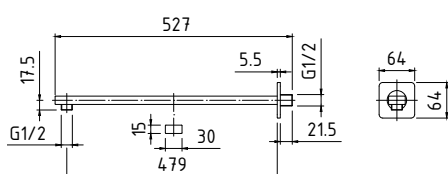
**R13**

Ramię prysznicowe poziome
profil kwadrat 24x24mm,
długość 400mm, do baterii
podtynkowych



I GRUPA RABATOWA

indeks	pakow. ☐	cena netto [zł]
35-207-0002-000	1	154,31

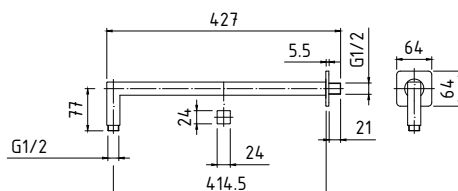
**R14**

Ramię prysznicowe poziome
profil kwadrat 24x24mm,
długość 500mm, do baterii
podtynkowych



I GRUPA RABATOWA

indeks	pakow. ☐	cena netto [zł]
35-207-0002-001	1	180,04

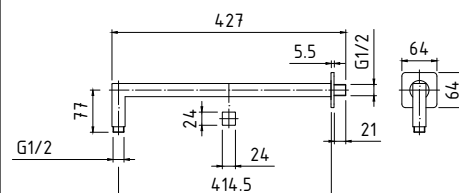
**R15**

Ramię prysznicowe poziome
profil okrągły Ø 22, długość
400mm, do baterii
podtynkowych



I GRUPA RABATOWA

indeks	pakow. ☐	cena netto [zł]
35-207-0001-000	1	102,87

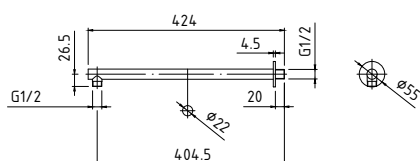
**R16**

Ramię prysznicowe poziome
profil okrągły Ø 22, długość
500mm, do baterii
podtynkowych



I GRUPA RABATOWA

indeks	pakow. ☐	cena netto [zł]
35-207-0001-001	1	122,17

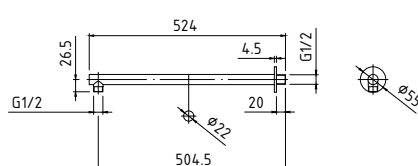



Serie klasycznych baterii łazienkowych oraz kuchennych, w których
**TRADYCJA ŁĄCZY SIĘ
Z NOWOCZESNOŚCIĄ**



ARMATURA KUCHENNA I ŁAZIENKOWA 89-123

Baterie WEGA	90
Baterie RENO	92
Baterie kuchenne i łazienkowe	94
głowica 40	94
głowica 35	98
Baterie ciśnieniowe	108
Syfony	108
Korki zamykające	109
Komplety prysznicowe	114
Słuchawki z deszczownicą	115
Słuchawki	116
Drażki prysznicowe	119
Uchwyty punktowe	120
Wężę prysznicowe	121
Akcesoria łazienkowe z przyssawką	122

84401**WEGA**

Bateria umywalkowa stojąca



GŁOWICA 35



GRUPA RABATOWA

NEXE
new line

indeks	kolor	pakow. ☐	cena netto [zł]
36-018-0300-003	czarny mat	1	283,62

**84401-1****WEGA**Bateria umywalkowa stojąca
nablatowa

GŁOWICA 35



GRUPA RABATOWA

NEXE
new line

indeks	kolor	pakow. ☐	cena netto [zł]
36-018-0310-003	czarny mat	1	584,60

**84402****WEGA**

Bateria bidetowa stojąca



GŁOWICA 35



GRUPA RABATOWA

NEXE
new line

indeks	kolor	pakow. ☐	cena netto [zł]
36-018-0700-003	czarny mat	1	300,98

**84403****WEGA**

Bateria wannowa naścienna



GŁOWICA 35



GRUPA RABATOWA

NEXE
new line

indeks	kolor	pakow. ☐	cena netto [zł]
36-018-0000-003	czarny mat	1	387,81

**84404****WEGA**

Bateria prysznicowa naścienna



GŁOWICA 35



GRUPA RABATOWA

NEXE
new line

indeks	kolor	pakow. ☐	cena netto [zł]
36-018-0600-003	czarny mat	1	297,51

**84405****WEGA**Bateria zlewozmywakowa
stojąca

GŁOWICA 35



GRUPA RABATOWA

NEXE
new line

indeks	kolor	pakow. ☐	cena netto [zł]
36-018-0500-003	czarny mat	1	457,26



84404-11**WEGA**
Deszczownia z baterią
natryskową naścienna

GŁOWICA 35

(N) GRUPA RABATOWA**NEXE**
new line

indeks	kolor	pakow. ☐	cena netto [zł]
36-018-1600-003	czarny mat	1	1146,05

**84409-1****WEGA**
Bateria prysznicowa
podtynkowa

GŁOWICA 35

(N) GRUPA RABATOWA**NEXE**
new line

indeks	kolor	pakow. ☐	cena netto [zł]
36-018-0621-000	czarny mat	1	792,75

**84405****WEGA**
Bateria zlewozmywakowa
stojąca

GŁOWICA 35

(N) GRUPA RABATOWA**NEXE**
new line

indeks	kolor	pakow. ☐	cena netto [zł]
36-018-0500-001	biała	1	457,26

**84401****WEGA**
Bateria umywalkowa stojąca

GŁOWICA 35

(N) GRUPA RABATOWA**NEXE**
new line

indeks	kolor	pakow. ☐	cena netto [zł]
36-018-0300-000	chrom	1	272,04

**84401-1****WEGA**
Bateria umywalkowa stojąca
nablatowa

GŁOWICA 35

(N) GRUPA RABATOWA**NEXE**
new line

indeks	kolor	pakow. ☐	cena netto [zł]
36-018-0310-000	chrom	1	530,20

**84402****WEGA**
Bateria bidetowa stojąca

GŁOWICA 35

(N) GRUPA RABATOWA**NEXE**
new line

indeks	kolor	pakow. ☐	cena netto [zł]
36-018-0700-000	chrom	1	285,94



84403**WEGA**

Bateria wannowa naścienna



GŁOWICA 35



GRUPA RABATOWA

NEXE
new line

indeks	kolor	pakow. ☐	cena netto [zł]
36-018-0000-000	chrom	1	346,13

**84404****WEGA**

Bateria prysznicowa naścienna



GŁOWICA 35



GRUPA RABATOWA

NEXE
new line

indeks	kolor	pakow. ☐	cena netto [zł]
36-018-0600-000	chrom	1	260,46

**84405****WEGA**

Bateria zlewozmywakowa stojąca



GŁOWICA 35



GRUPA RABATOWA

NEXE
new line

indeks	kolor	pakow. ☐	cena netto [zł]
36-018-0500-000	chrom	1	399,38

**84404-11****WEGA**

Deszczownia z baterią natryskową naścienną



GŁOWICA 35



GRUPA RABATOWA

NEXE
new line

indeks	kolor	pakow. ☐	cena netto [zł]
36-018-1600-000	chrom	1	850,86

**84409-1****WEGA**

Bateria prysznicowa podtynkowa



GŁOWICA 35



GRUPA RABATOWA

NEXE
new line

indeks	kolor	pakow. ☐	cena netto [zł]
36-018-0621-000	chrom	1	690,90

**85501****RENO**

Bateria umywalkowa stojąca



GŁOWICA 35



GRUPA RABATOWA

NEXE
new line

indeks	kolor	pakow. ☐	cena netto [zł]
36-017-0300-000		1	262,78



85501-1**RENO**
Bateria umywalkowa stojąca
nablatowa

GŁOWICA 35

(N) GRUPA RABATOWA**NEXE**
new line

indeks	pakow. 	cena netto ^[zł]
36-017-0310-000	1	575,34

**85502****RENO**
Bateria bidetowa stojąca

GŁOWICA 35

(N) GRUPA RABATOWA**NEXE**
new line

indeks	pakow. 	cena netto ^[zł]
36-017-0700-000	1	274,35

**85503****RENO**
Bateria wannowa naścienna

GŁOWICA 35

(N) GRUPA RABATOWA**NEXE**
new line

indeks	pakow. 	cena netto ^[zł]
36-017-0000-000	1	366,96

**85504****RENO**
Bateria prysznicowa naścienna

GŁOWICA 35

(N) GRUPA RABATOWA**NEXE**
new line

indeks	pakow. 	cena netto ^[zł]
36-017-0600-000	1	320,66



CAR07

CARLO
bateria zlewozmywakowa
wysoka stojąca



GŁOWICA 40

I GRUPA RABATOWA

indeks	pakow. 	cena netto ^[zł]
35-015-0500-001	1 10	173,41

**CAR05/22**

CARLO
bateria zlewozmywakowa
stojąca



GŁOWICA 40

I GRUPA RABATOWA

indeks	wyl. [cm]	pakow. 	cena netto ^[zł]
35-015-0500-000	22	1 10	143,68

**CAR06/22**

CARLO
bateria zlewozmywakowa
naścienna



GŁOWICA 40

I GRUPA RABATOWA

indeks	wyl. [cm]	pakow. 	cena netto ^[zł]
35-015-0400-000	22	1 10	206,93

**CAR03**

CARLO
bateria wannowa naścienna
bez akcesoriów



GŁOWICA 40

I GRUPA RABATOWA

indeks	pakow. 	cena netto ^[zł]
35-015-0000-000	1 10	240,11

**CAR06/18**

CARLO
bateria umywalkowa
naścienna



GŁOWICA 40

I GRUPA RABATOWA

indeks	wyl. [cm]	pakow. 	cena netto ^[zł]
35-015-0200-000	18	1 10	203,78



CAR04

CARLO
bateria prysznicowa
naścienna bez akcesoriów



GŁOWICA 40

I GRUPA RABATOWA

indeks	pakow. 	cena netto ^[zł]
35-015-0600-000	1 10	186,40

**CAR01**

CARLO
bateria umywalkowa
stojąca



GŁOWICA 40

I GRUPA RABATOWA

indeks	pakow. 	cena netto ^[zł]
35-015-0100-000	1 10	175,32

**CAR02**

CARLO
bateria bidetowa



GŁOWICA 40

I GRUPA RABATOWA

indeks	pakow. 	cena netto ^[zł]
35-015-0700-000	1 10	172,20

**363**

DALIA
bateria zlewozmywakowa
stojąca



GŁOWICA 40

I GRUPA RABATOWA

indeks	wyl. [cm]	pakow. 	cena netto ^[zł]
35-010-0500-000	22	1 10	123,99

**316**

DALIA
bateria zlewozmywakowa
naścienna



GŁOWICA 40

I GRUPA RABATOWA

indeks	wyl. [cm]	pakow. 	cena netto ^[zł]
35-010-0400-000	22	1 10	182,46



354**DALIA**
bateria wannowa naścienna

GŁOWICA 40

GRUPA RABATOWA

indeks	pakow. 	cena netto ^[zł]
35-010-0000-000	1 10	256,87

**316****DALIA**
bateria umywalkowa
naścienna

GŁOWICA 40

GRUPA RABATOWA

indeks	wyl. [cm]	pakow. 	cena netto ^[zł]
35-010-0200-001	18	1 10	180,66

**315****DALIA**
bateria prysznicowa
naścienna

GŁOWICA 40

GRUPA RABATOWA

indeks	pakow. 	cena netto ^[zł]
35-010-0600-000	1 10	194,85

**361****DALIA**
bateria umywalkowa
stojąca

GŁOWICA 40

GRUPA RABATOWA

indeks	pakow. 	cena netto ^[zł]
35-010-0100-000	1 10	152,34

**362****DALIA**
bateria bidetowa

GŁOWICA 40

GRUPA RABATOWA

indeks	pakow. 	cena netto ^[zł]
35-010-0700-000	1 10	159,44



163**MALWA**
bateria zlewozmywakowa
stożąca

GŁOWICA 40

GRUPA RABATOWA

indeks	wyl. [cm]	pakow. 	cena netto [zł]
35-008-0500-001	16	1 10	161,27
35-008-0500-000	22	1 10	161,27

**163/1****MALWA**
bateria zlewozmywakowa
stożąca ze skośną wylewką

GŁOWICA 40

GRUPA RABATOWA

indeks	wyl. [cm]	pakow. 	cena netto [zł]
35-008-0500-002		1 10	146,33

**166****MALWA**
bateria zlewozmywakowa
naścienna

GŁOWICA 40

GRUPA RABATOWA

indeks	wyl. [cm]	pakow. 	cena netto [zł]
35-008-0400-000	22	1 10	222,21

**164****MALWA**
bateria wannowa naścienna

GŁOWICA 40

GRUPA RABATOWA

indeks	pakow. 	cena netto [zł]
35-008-0000-000	1 10	277,76

**166****MALWA**
bateria umywalkowa
naścienna

GŁOWICA 40

GRUPA RABATOWA

indeks	wyl. [cm]	pakow. 	cena netto [zł]
35-008-0200-000	18	1 10	218,63



165
MALWA
bateria prysznicowa
naścienna



GŁOWICA 40

GRUPA RABATOWA

indeks	pakow.	cena netto [zł]
35-008-0600-000	1 10	232,97



161
MALWA
bateria umywalkowa
stojąca



GŁOWICA 40

GRUPA RABATOWA

indeks	pakow.	cena netto [zł]
35-008-0100-000	1 10	182,78



162
MALWA
bateria bidetowa



GŁOWICA 40

GRUPA RABATOWA

indeks	pakow.	cena netto [zł]
35-008-0700-000	1 10	197,12



FAB07
FABIO
bateria zlewozmywakowa
stojąca wysoka



GŁOWICA 40

GRUPA RABATOWA

indeks	pakow.	cena netto [zł]
35-016-0500-001	1 12	194,39



COR07
CORNELIA
bateria zlewozmywakowa
stojąca wysoka



GŁOWICA 35

GRUPA RABATOWA

indeks	pakow.	cena netto [zł]
35-017-0500-001	1 10	267,73



ANG05/22
ANGELA
bateria zlewozmywakowa stojąca



GŁOWICA 35

GRUPA RABATOWA

indeks	wylewka [cm]	pakow.	cena netto [zł]
35-011-0500-000	22	1 10	137,11



ANG06/22**ANGELA**

bateria zlewozmywakowa naścienna



GŁOWICA 35

I GRUPA RABATOWA

indeks	wylewka [cm]	pakow. ☐ ☐	cena netto [zł]
35-011-0400-000	22	1 10	219,07

**ANG04****ANGELA**

bateria prysznicowa bez akcesoriów



GŁOWICA 35

I GRUPA RABATOWA

indeks	pakow. ☐ ☐	cena netto [zł]
35-011-0600-000	1 10	196,74

**ANG01****ANGELA**

bateria umywalkowa stojąca



GŁOWICA 35

I GRUPA RABATOWA

indeks	pakow. ☐ ☐	cena netto [zł]
35-011-0100-000	1 10	173,00

**ANG02****ANGELA**

bateria bidetowa



GŁOWICA 35

I GRUPA RABATOWA

indeks	pakow. ☐ ☐	cena netto [zł]
35-011-0700-000	1 10	177,35

**BIA04****BIANCA**

bateria prysznicowa bez akcesoriów



GŁOWICA 35

I GRUPA RABATOWA

indeks	pakow. ☐ ☐	cena netto [zł]
35-012-0600-000	1 10	203,23

**BIA01****BIANCA**

bateria umywalkowa stojąca



GŁOWICA 35

I GRUPA RABATOWA

indeks	pakow. ☐ ☐	cena netto [zł]
35-012-0100-000	1 10	212,90



ANG03

ANGELA
bateria wannowa bez
akcesoriów



GŁOWICA 35

I GRUPA RABATOWA

indeks	pakow. 	cena netto ^[2]
35-011-0000-000	1 12	244,39

**ANG06/18**

ANGELA
bateria umywalkowa
naścienna



GŁOWICA 35

I GRUPA RABATOWA

indeks	wyl. [cm]	pakow. 	cena netto ^[2]
35-011-0200-000	18	1 10	216,10

**BIA05/22**

BIANCA
bateria zlewozmywakowa
stożąca



GŁOWICA 35

I GRUPA RABATOWA

indeks	wyl. [cm]	pakow. 	cena netto ^[2]
35-012-0500-000	22	1 10	137,58

**BIA06/22**

BIANCA
bateria zlewozmywakowa
naścienna



GŁOWICA 35

I GRUPA RABATOWA

indeks	wyl. [cm]	pakow. 	cena netto ^[2]
35-012-0400-000	22	1 10	231,01



BIA03**BIANCA**bateria wannowa bez
akcesoriów

GŁOWICA 35

I GRUPA RABATOWA

indeks	pakow. 	cena netto ^[2]
35-012-0000-000	1 10	273,43

**BIA06/18****BIANCA**bateria umywalkowa
naścienna

GŁOWICA 35

I GRUPA RABATOWA

indeks	wyl. [cm]	pakow. 	cena netto ^[2]
35-012-0200-000	18	1 10	228,10

**ENR03****ENRICA**bateria wannowa bez
akcesoriów

GŁOWICA 35

I GRUPA RABATOWA

indeks	pakow. 	cena netto ^[2]
35-013-0000-000	1 10	219,32

**ENR06/18****ENRICA**bateria umywalkowa
naścienna

GŁOWICA 35

I GRUPA RABATOWA

indeks	wyl. [cm]	pakow. 	cena netto ^[2]
35-013-0200-000	18	1 10	191,54



BIA02**BIANCA**

bateria bidetowa



GŁOWICA 35

I GRUPA RABATOWA

indeks	pakow. 	cena netto [zł]
35-012-0700-000	1 10	209,10

**ENR07****ENRICA**

bateria zlewozmywakowa stojąca wysoka



GŁOWICA 35

I GRUPA RABATOWA

indeks	pakow. 	cena netto [zł]
35-013-0500-001	1 10	174,26

**ENR05/16
ENR05/22****ENRICA**
bateria zlewozmywakowa stojąca

GŁOWICA 35

I GRUPA RABATOWA

indeks	wyl. [cm]	pakow. 	cena netto [zł]
35-013-0501-000	16	1 10	127,21
35-013-0500-000	22	1 10	132,98

**ENR06/22****ENRICA**

bateria zlewozmywakowa ścienna



GŁOWICA 35

I GRUPA RABATOWA

indeks	wyl. [cm]	pakow. 	cena netto [zł]
35-013-0400-000	22	1 10	194,47

**ENR04****ENRICA**

bateria prysznicowa bez akcesoriów



GŁOWICA 35

I GRUPA RABATOWA

indeks	pakow. 	cena netto [zł]
35-013-0600-000	1 10	176,91

**ENR01****ENRICA**

bateria umywalkowa stojąca



GŁOWICA 35

I GRUPA RABATOWA

indeks	pakow. 	cena netto [zł]
35-013-0100-000	1 10	162,27



ENR02**ENRICA**
bateria bidetowa

GŁOWICA 35

GRUPA RABATOWA

indeks	pakow. 	cena netto ^[zł]
35-013-0700-000	1 10	159,39

**1004****IRYS**
bateria prysznicowa
naścienna

GŁOWICA 35

GRUPA RABATOWA

indeks	pakow. 	cena netto ^[zł]
35-001-0600-000	1 12	241,82

**1001-I
1001-I/BS****IRYS**
bateria umywalkowa
stojąca z/bez spustu

GŁOWICA 35

GRUPA RABATOWA

indeks	spust	pakow. 	cena netto ^[zł]
35-001-0100-001	tak	1 12	169,12
35-001-0100-002	nie	1 12	158,17

**1005****IRYS**
bateria zlewozmywakowa
stojąca

GŁOWICA 35

GRUPA RABATOWA

indeks	wyl. [cm]	pakow. 	cena netto ^[zł]
35-001-0500-000	16	1 10	171,15
35-001-0501-000	22	1 10	171,15

**1006****IRYS**
bateria zlewozmywakowa
naścienna

GŁOWICA 35

GRUPA RABATOWA

indeks	wyl. [cm]	pakow. 	cena netto ^[zł]
35-001-0400-000	22	1 12	245,56



1003**IRYS**
bateria wannowa naścienna

GŁOWICA 35

GRUPA RABATOWA

indeks	pakow. 	cena netto [zł]
35-001-0000-000	1 12	279,05

**1006/1****IRYS**
bateria umywalkowa naścienna

GŁOWICA 35

GRUPA RABATOWA

indeks	wyl. [cm]	pakow. 	cena netto [zł]
35-001-0200-000	18	1 10	239,99
35-001-0201-000	14	1 10	234,41

**1002****IRYS**
bateria bidetowa

GŁOWICA 35

GRUPA RABATOWA

indeks	pakow. 	cena netto [zł]
35-001-0700-000	1 10	184,07

**LAU07****LAURA**
bateria zlewozmywakowa stojąca wysoka

GŁOWICA 35

GRUPA RABATOWA

indeks	pakow. 	cena netto [zł]
35-014-0500-001	1 10	179,01

**LAU05/22****LAURA**
bateria zlewozmywakowa stojąca

GŁOWICA 35

GRUPA RABATOWA

indeks	wyl. [cm]	pakow. 	cena netto [zł]
35-014-0500-000	22	1 10	135,82



LAU06/22

LAURA
bateria zlewozmywakowa
naścienna



GŁOWICA 35

I GRUPA RABATOWA

indeks	wyl. [cm]	pakow. 	cena netto [zł]
35-014-0400-000	22	1 10	196,34

**LAU04**

LAURA
bateria prysznicowa bez
akcesoriów



GŁOWICA 35

I GRUPA RABATOWA

indeks	wyl. [cm]	pakow. 	cena netto [zł]
35-014-0600-000		1 10	178,62

**LAU01**

LAURA
bateria umywalkowa
stojąca



GŁOWICA 35

I GRUPA RABATOWA

indeks	wyl. [cm]	pakow. 	cena netto [zł]
35-014-0100-000		1 10	168,34

**LAU02**

LAURA
bateria bidetowa



GŁOWICA 35

I GRUPA RABATOWA

indeks	wyl. [cm]	pakow. 	cena netto [zł]
35-014-0700-000		1 10	160,92

**902/B**

LILIA
bateria zlewozmywakowa
stojąca



GŁOWICA 35

I GRUPA RABATOWA

indeks	wyl. [cm]	pakow. 	cena netto [zł]
35-003-0500-000	22	1 10	171,15

**903/B**

LILIA
bateria zlewozmywakowa
naścienna



GŁOWICA 35

I GRUPA RABATOWA

indeks	wyl. [cm]	pakow. 	cena netto [zł]
35-003-0400-000	22	1 12	245,56



1015**LILIA**

bateria wannowa naścienna



GŁOWICA 35

GRUPA RABATOWA

indeks	pakow. 	cena netto ^[2]
35-003-0000-000	1 12	279,05

**2015****LILIA**bateria prysznicowa
naścienna

GŁOWICA 35

GRUPA RABATOWA

indeks	pakow. 	cena netto ^[2]
35-003-0600-000	1 12	241,82

**LAU03****LAURA**bateria wannowa bez
akcesoriów

GŁOWICA 35

GRUPA RABATOWA

indeks	pakow. 	cena netto ^[2]
35-014-0000-000	1 10	225,87

**LAU06/18****LAURA**bateria umywalkowa
naścienna

GŁOWICA 35

GRUPA RABATOWA

indeks	wyl. [cm]	pakow. 	cena netto ^[2]
35-014-0200-000	18	1 10	193,38

**903/B****LILIA**bateria umywalkowa
naścienna

GŁOWICA 35

GRUPA RABATOWA

indeks	wyl. [cm]	pakow. 	cena netto ^[2]
35-003-0200-000	16	1 12	239,99



3015-I
3015-I/BS**LILIA**
bateria umywalkowa
stożąca z/bez spustu

GŁOWICA 35

GRUPA RABATOWA

indeks	spust	pakow. 	cena netto ^[zł]
35-003-0100-001	tak	1 12	169,12
35-003-0100-002	nie	1 12	158,17

**4015****LILIA**
bateria bidetowa

GŁOWICA 35

GRUPA RABATOWA

indeks	pakow. 	cena netto ^[zł]
35-003-0700-000	1 10	189,75

**7007-1 / 7007-2****MAK**
bateria umywalkowa
naścienna jednocierowowa
typ C/typ S

GRUPA RABATOWA

indeks	wyl. [mm]	pakow. 	cena netto ^[zł]
35-000-0002-000	18 C	2 40	75,46
35-000-0003-000	18 S	2 40	75,46

**7003****MAK**
bateria wannowa naścienna

GRUPA RABATOWA

indeks	pakow. 	cena netto ^[zł]
35-000-0000-000	1 10	290,25

**7004****MAK**
bateria prysznicowa
naścienna

GRUPA RABATOWA

indeks	pakow. 	cena netto ^[zł]
35-000-0600-000	1 20	217,79

**7005****MAK**
bateria zlewomywakowa
stożąca

GRUPA RABATOWA

indeks	pakow. 	cena netto ^[zł]
35-000-0502-000	1 10	164,35



7006 / 7006/1**MAK**
bateria umywalkowa naścienna**I** GRUPA RABATOWA

indeks	wyl. [cm]	typ	symbol	pak.	cena netto [zł]
35-000-0200-000	18	C	7006	1 10	180,92
35-000-0201-000	18	S	7006	1 10	180,92
35-000-0400-000	22	C	7006-1	1 10	185,98
35-000-0401-000	22	S	7006-1	1 10	185,98

**S2**Zawór ciśnieniowy
spłukujący czasowy**N** GRUPA RABATOWA**NEXE**
new line

indeks	pakow.	cena netto [zł]
35-501-0002-000	1	193,53

**S3**Bateria ciśnieniowa
umywalkowa czasowa**N** GRUPA RABATOWA**NEXE**
new line

indeks	pakow.	cena netto [zł]
35-501-0003-000	1	157,27

**SYMISO**

Syfon mosiężny okrągły

N GRUPA RABATOWA**NEXE**
new line

indeks	kolor	pakow.	cena netto [zł]
36-200-0000-000	chrom	1 1	142,37
36-200-0000-003	czarny mat	1 1	203,39
36-200-0000-006	złoty	1 1	203,39
36-200-0000-007	różowe złoto	1 1	203,39

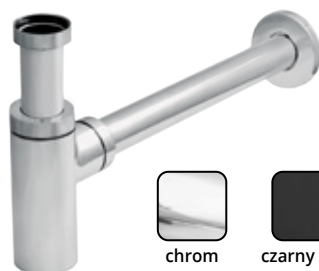

chrom



czarny mat



złoty



różowe złoto

S4Bateria ciśnieniowa
umywalkowa czasowa**N** GRUPA RABATOWA**NEXE**
new line

indeks	pakow.	cena netto [zł]
35-501-0004-000	1	157,27

**SYMYSK**

Syfon mosiężny kwadratowy

N GRUPA RABATOWA**NEXE**
new line

indeks	kolor	pakow.	cena netto [zł]
36-220-0000-000	chrom	1 1	165,25
36-220-0000-001	biały	1 1	241,52
36-220-0000-003	czarny mat	1 1	241,52
36-220-0000-006	złoty	1 1	241,52
36-220-0000-007	różowe złoto	1 1	241,52

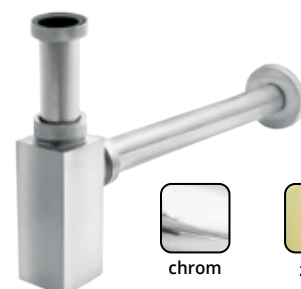

chrom



złoty



biały



różowe złoto



czarny mat

SPPMWK**CLICK-CLACK**

G1¼ z przelewem, wysoki z
koszem, przycisk duży,
okrągły, wypukły

(N) GRUPA RABATOWA

NEXE
new line

indeks	kolor	pakow. ☐ ☐	cena netto [zł]
36-300-0000-000	chrom	1 1	74,95
36-300-0000-003	czarny mat	1 1	74,95
36-300-0000-006	złoty	1 1	74,95
36-300-0000-007	różowe złoto	1 1	74,95



chrom



złoty



czarny mat

różowe
złoto**SPPMWK****CLICK-CLACK**

G1¼ z przelewem, wysoki z
koszem, przycisk duży,
okrągły, płaski

(N) GRUPA RABATOWA

NEXE
new line

indeks	kolor	pakow. ☐ ☐	cena netto [zł]
36-300-0010-000	chrom	1 1	74,95
36-300-0010-001	biały	1 1	74,95
36-300-0010-003	czarny mat	1 1	74,95
36-300-0010-006	złoty	1 1	74,95
36-300-0010-007	różowe złoto	1 1	74,95



chrom



złoty



biały

różowe
złoto

czarny mat

**SPPMWK****CLICK-CLACK**

G1¼ z przelewem, wysoki z
koszem, przycisk
kwadratowy, wypukły

(N) GRUPA RABATOWA

NEXE
new line

indeks	kolor	pakow. ☐ ☐	cena netto [zł]
36-300-0020-000	chrom	1 1	78,52
36-300-0020-001	biały	1 1	78,52
36-300-0020-003	czarny mat	1 1	78,52
36-300-0020-006	złoty	1 1	78,52
36-300-0020-007	różowe złoto	1 1	78,52



chrom



złoty



biały

różowe
złoto

czarny mat

**SPPMK****CLICK-CLACK**

G1¼ z przelewem, z koszem,
przycisk duży, okrągły,
wypukły

(N) GRUPA RABATOWA

NEXE
new line

indeks	kolor	pakow. ☐ ☐	cena netto [zł]
36-300-1000-000	chrom	1 1	74,95
36-300-1000-001	biały	1 1	74,95
36-300-1000-003	czarny mat	1 1	74,95
36-300-1000-006	złoty	1 1	74,95
36-300-1000-007	różowe złoto	1 1	74,95



chrom



złoty





biały

różowe
złoto

czarny mat



SPPMK**CLICK-CLACK**G1¼ z przelewem, z koszem,
przycisk duży, okrągły, płaski**(N)** GRUPA RABATOWA**NEXE**
new line

indeks	kolor	pakow.  	cena netto [zł]
36-300-1010-000	chrom	1 1	74,95
36-300-1010-001	biały	1 1	74,95
36-300-1010-003	czarny mat	1 1	74,95
36-300-1010-006	złoty	1 1	74,95
36-300-1010-007	różowe złoto	1 1	74,95



chrom



złoty





biały

różowe
złoto

czarny mat

**SPPMW****CLICK-CLACK**G1¼ z przelewem, wysoki
przycisk duży okrągły
wypukły**(N)** GRUPA RABATOWA**NEXE**
new line

indeks	kolor	pakow.  	cena netto [zł]
36-400-0000-000	chrom	1 1	71,39
36-400-0000-001	biały	1 1	71,39
36-400-0000-003	czarny mat	1 1	71,39



chrom





biały



czarny mat

**SPPMW****CLICK-CLACK**G1¼ z przelewem, wysoki
przycisk duży okrągły płaski**(N)** GRUPA RABATOWA**NEXE**
new line

indeks	kolor	pakow.  	cena netto [zł]
36-400-0010-000	chrom	1 1	71,39
36-400-0010-003	czarny mat	1 1	71,39





chrom



czarny mat

**SPPMW****CLICK-CLACK**G1¼ z przelewem, wysoki
przycisk kwadratowy wypukły**(N)** GRUPA RABATOWA**NEXE**
new line

indeks	kolor	pakow.  	cena netto [zł]
36-400-0020-000	chrom	1 1	76,15
36-400-0020-003	czarny mat	1 1	76,15



chrom



czarny mat



SPPM**CLICK-CLACK**G1¼ z przelewem, przycisk
duży okrągły wypukły**(N)** GRUPA RABATOWA**NEXE**
new line

indeks	kolor	pakow. ☐ ☐	cena netto [zł]
36-400-1000-000	chrom	1 1	71,39
36-400-1000-001	biały	1 1	71,39
36-400-1000-003	czarny mat	1 1	71,39



chrom



biały



czarny mat

**SPPM****CLICK-CLACK**G1¼ z przelewem, przycisk
duży okrągły płaski**(N)** GRUPA RABATOWA**NEXE**
new line

indeks	kolor	pakow. ☐ ☐	cena netto [zł]
36-400-1010-000	chrom	1 1	71,39
36-400-1010-003	czarny mat	1 1	71,39



chrom



czarny mat

**SPPM****CLICK-CLACK**G1¼ z przelewem, przycisk
kwadratowy wypukły**(N)** GRUPA RABATOWA**NEXE**
new line

indeks	kolor	pakow. ☐ ☐	cena netto [zł]
36-400-1020-000	chrom	1 1	76,15
36-400-1020-003	czarny mat	1 1	76,15



chrom



czarny mat

**SPMWK****CLICK-CLACK**G1¼ bez przelewu, wysoki, z
koszem, przycisk duży
okrągły, wypukły**(N)** GRUPA RABATOWA**NEXE**
new line

indeks	kolor	pakow. ☐ ☐	cena netto [zł]
36-310-0000-000	chrom	1 1	74,95
36-310-0000-001	biały	1 1	79,72
36-310-0000-003	czarny mat	1 1	79,72



chrom



biały



czarny mat



SPMWK**CLICK-CLACK**

G1¼ bez przelewu, wysoki, z
koszem, przycisk duży
okrągły, płaski

(N) GRUPA RABATOWA

NEXE
new line

indeks	kolor	pakow. ☐ ☐	cena netto [zł]
36-310-0010-000	chrom	1 1	73,77
36-310-0010-003	czarny mat	1 1	73,77



chrom



czarny mat

**SPMWK****CLICK-CLACK**

G1¼ bez przelewu, wysoki, z
koszem, przycisk
kwadratowy, wypukły

(N) GRUPA RABATOWA

NEXE
new line

indeks	kolor	pakow. ☐ ☐	cena netto [zł]
36-310-0020-000	chrom	1 1	76,15
36-310-0020-003	czarny mat	1 1	76,15



chrom



czarny mat

**SPPMWK****CLICK-CLACK**

G1¼ z przelewem, wysoki, z
koszem, przycisk ceramiczny
duży, okrągły, wypukły

(N) GRUPA RABATOWA

NEXE
new line

indeks	kolor	pakow. ☐ ☐	cena netto [zł]
36-300-0040-001	biały	1 1	80,90
36-300-0040-005	czarny	1 1	80,90



biały



czarny

**SPPT01E****CLICK-CLACK**

G1¼ z przelewem, przycisk
duży okrągły wypukły
chromowany

(N) GRUPA RABATOWA

NEXE
new line

indeks	kolor	pakow. ☐ ☐	cena netto [zł]
36-500-1000-000	biały	1 1	20,34



SPPT05E**CLICK-CLACK**

G1¼ z przelewem, przycisk mały okrągły płaski chromowany

(N) GRUPA RABATOWA

NEXE
new line

indeks	kolor	pakow. ☐ ☐	cena netto [zł]
36-500-1050-000	biały	1 1	18,80

**PR04**

Przycisk ceramiczny, duży okrągły, wypukły

(N) GRUPA RABATOWA

NEXE
new line

indeks	kolor	pakow. ☐ ☐	cena netto [zł]
36-140-0000-001	biały	1 1	22,04
36-140-0000-005	czarny	1 1	22,04



biały



czarny

**SPPTB01****CLICK-CLACK**

G1¼ z przelewem, z blokadą przycisk duży okrągły wypukły chromowany

(N) GRUPA RABATOWA

NEXE
new line

indeks	kolor	pakow. ☐ ☐	cena netto [zł]
36-500-1000-100	czarny	1 1	20,23

**PR01**

Przycisk mosiężny okrągły, wypukły

(N) GRUPA RABATOWA

NEXE
new line

indeks	kolor	pakow. ☐ ☐	cena netto [zł]
36-130-0000-000	chrom	1 1	20,81
36-130-0000-001	biały	1 1	20,81
36-130-0000-003	czarny mat	1 1	20,81
36-130-0000-006	złoty	1 1	20,81
36-130-0000-007	różowe złoto	1 1	20,81



chrom



złoty



biały



różowe złoto



czarny mat



PR02Przycisk mosiężny
okrągły, płaski**(N)** GRUPA RABATOWA**NEXE**
new line

indeks	kolor	pakow. ☐ ☐	cena netto [zł]
36-130-0010-000	chrom	1 1	20,81
36-130-0010-001	biały	1 1	20,81
36-130-0010-003	czarny mat	1 1	20,81
36-130-0010-006	złoty	1 1	20,81
36-130-0010-007	różowe złoto	1 1	20,81



chrom



złoty



biały

różowe
złoto

czarny mat

**PR03**Przycisk mosiężny
kwadratowy, wypukły**(N)** GRUPA RABATOWA**NEXE**
new line

indeks	kolor	pakow. ☐ ☐	cena netto [zł]
36-130-0020-000	chrom	1 1	26,93
36-130-0020-001	biały	1 1	30,61
36-130-0020-003	czarny mat	1 1	30,61
36-130-0020-006	złoty	1 1	30,61
36-130-0020-007	różowe złoto	1 1	30,61



chrom



złoty



biały

różowe
złoto

czarny mat

**8B**Korek zamykający
click-clack z przelewem,
umywalkowy, okrągły,
36 mm**(N)** GRUPA RABATOWA**NEXE**
new line

indeks	kolor	pakow. ☐ ☐	cena netto [zł]
36-104-0003-000	chrom	1 50	45,76

**12**Korek zamykający
click-clack z przelewem,
umywalkowy, kwadratowy,
68 mm**(N)** GRUPA RABATOWA**NEXE**
new line

indeks	kolor	pakow. ☐ ☐	cena netto [zł]
36-104-0000-000	chrom	1 30	80,12

**NA-112PR+NA-1113X****IBIZA**
komplet prysnicowy
ze słuchawką 3-funkcyjną**(I)** GRUPA RABATOWA

indeks	pakow. ☐ ☐	cena netto [zł]
35-200-0024-000	1 10	95,24



ZY-3046**LIMITA**komplet prysznicowy
ze słuchawką 1-funkcyjną**I** GRUPA RABATOWA

indeks	pakow. 	cena netto ^[zł]
35-200-0030-000	1 1	219,20

**HY-1290****MASSIMO**deszczownia ze słuchawką
1-funkcyjną**I** GRUPA RABATOWA

indeks	pakow. 	cena netto ^[zł]
35-200-0038-000	1 1	100,81

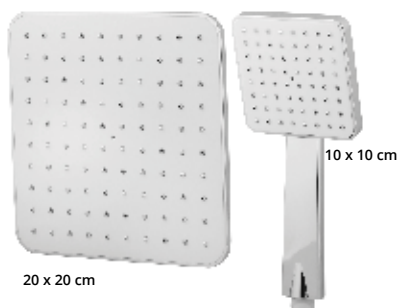

20 x 20 cm

10 x 10 cm

20Komplet prysznicowy
ze słuchawką 1-funkcyjną**N** GRUPA RABATOWA**NEXE**
new line

indeks	pakow. 	cena netto ^[zł]
36-105-0001-000	1 1	415,99

Produkt dostępny
do wyczerpania zapasów**JY-1302****MARCO**deszczownia ze słuchawką
1-funkcyjną**I** GRUPA RABATOWA

indeks	pakow. 	cena netto ^[zł]
35-200-0037-000	1 1	113,27



20 x 20 cm

10
x 10 cm**JY-1504****MAURO**deszczownia ze słuchawką
1-funkcyjną**I** GRUPA RABATOWA

indeks	pakow. 	cena netto ^[zł]
35-200-0036-000	1 1	87,82

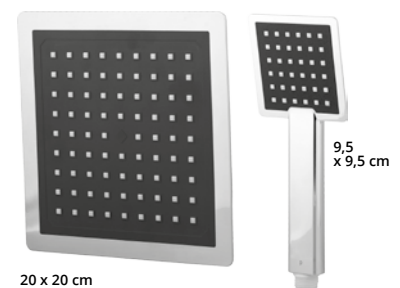

20 x 20 cm

9,5
x 9,5 cm

TS-1128

MAXIMO
deszczownia ze słuchawką
1-funkcyjną



I GRUPA RABATOWA

indeks	pakow.	cena netto [zł]
35-200-0031-000	1 1	68,73

**HY-1310**

CAMBIO/GOMERA
słuchawka prysznicowa
1-funkcyjna



I GRUPA RABATOWA

indeks	pakow.	cena netto [zł]
35-101-0014-000	1 100	14,98

**HY-151B**

PETRA
słuchawka prysznicowa
1-funkcyjna



N GRUPA RABATOWA

NEXE
new line

indeks	pakow.	cena netto [zł]
36-101-0000-003	1 100	21,70

**HY-026**

RETINA
słuchawka prysznicowa
1-funkcyjna



N GRUPA RABATOWA

NEXE
new line

indeks	pakow.	cena netto [zł]
36-101-0001-000	1 100	23,37

**SH-1007**

ALA
słuchawka prysznicowa
1-funkcyjna



I GRUPA RABATOWA

indeks	pakow.	cena netto [zł]
35-100-0001-000	1 200	13,81

**NA-1151P**

AZUR
słuchawka prysznicowa
1-funkcyjna



I GRUPA RABATOWA

indeks	pakow.	cena netto [zł]
35-101-0007-000	1 40	21,04



TS-1787

ANDREA

słuchawka zlewozmywakowa
2-funkcyjna do baterii
z wymiową wylewką



I GRUPA RABATOWA

indeks	pakow. ☐ ☐	cena netto [zł]
35-102-0002-000	1 40	40,57



SH-2005

KINGA

słuchawka zlewozmywakowa
2-funkcyjna do baterii
z wymiową wylewką



I GRUPA RABATOWA

indeks	pakow. ☐ ☐	cena netto [zł]
35-100-0006-000	1 40	40,57



HY-1406

GERTA

słuchawka prysznicowa
3-funkcyjna



N GRUPA RABATOWA

NEXE
new line

indeks	pakow. ☐ ☐	cena netto [zł]
36-103-0002-000	1 20	30,09



**funkcja
STOP**

HY-001B

MORENA

słuchawka prysznicowa
3-funkcyjna



N GRUPA RABATOWA

NEXE
new line

indeks	pakow. ☐ ☐	cena netto [zł]
36-103-0000-103	1 20	52,09



**Wciśnij przycisk,
aby zmienić funkcję
strumienia wody!**

HY-018C

NOEMI

słuchawka prysznicowa
3-funkcyjna



N GRUPA RABATOWA

NEXE
new line

indeks	pakow. ☐ ☐	cena netto [zł]
36-103-0005-000	1 20	37,04



HY-002B

TREVI

słuchawka prysznicowa
3-funkcyjna



N GRUPA RABATOWA

NEXE
new line

indeks	pakow. ☐ ☐	cena netto [zł]
36-103-0001-103	1 20	52,09



**Wciśnij przycisk,
aby zmienić funkcję
strumienia wody!**

HY-006

WEDERA
słuchawka prysznicowa
3-funkcyjna



(N) GRUPA RABATOWA

NEXE
new line

indeks	pakow.	cena netto
		[zł]
36-103-0004-000	1 20	30,09



Czyszczenie mechaniczne

NA-1235

GAZELA
słuchawka prysznicowa
3-funkcyjna



(I) GRUPA RABATOWA

indeks	pakow.	cena netto
		[zł]
35-103-0009-000	1 50	24,39

**NA-1115B**

BORNEO
słuchawka prysznicowa
3-funkcyjna



(I) GRUPA RABATOWA

indeks	pakow.	cena netto
		[zł]
35-103-0005-000	1 25	39,38

**NA-1113X**

ITAKA
słuchawka prysznicowa
3-funkcyjna



(I) GRUPA RABATOWA

indeks	pakow.	cena netto
		[zł]
35-103-0003-000	1 50	22,63

**NA-1113**

FIDZI
słuchawka prysznicowa
3-funkcyjna



(I) GRUPA RABATOWA

indeks	pakow.	cena netto
		[zł]
35-103-0010-000	1 40	23,45

**NA-1113S**

TRIO
słuchawka prysznicowa
3-funkcyjna



(I) GRUPA RABATOWA

indeks	pakow.	cena netto
		[zł]
35-103-0004-000	1 50	29,86



HY-053

MARINI
słuchawka prysznicowa
5-funkcyjna



(N) GRUPA RABATOWA

NEXE
new line

indeks	pakow. ☐ ☐	cena netto [zł]
36-105-0003-000	1 50	33,39



NA-1223

BRAVA
słuchawka prysznicowa
5-funkcyjna



(I) GRUPA RABATOWA

indeks	pakow. ☐ ☐	cena netto [zł]
35-105-0003-000	1 20	39,25



TS-1124

SIMONA
słuchawka prysznicowa
5-funkcyjna



(I) GRUPA RABATOWA

indeks	pakow. ☐ ☐	cena netto [zł]
35-105-0008-000	1 30	43,74



BD-9009

LANGUSTA
dźwążek prysznicowy
z przysawką

(I) GRUPA RABATOWA

indeks	pakow. ☐ ☐	cena netto [zł]
35-200-0043-000	1 10	123,49

Produkt dostępny
do wyczerpania zapasów



ok. \varnothing 22,5 mm
Możliwość regulacji



TS-4017

REMO
dźwążek prysznicowy z mydelniczką
dł. 60cm

(I) GRUPA RABATOWA

indeks	pakow. ☐ ☐	cena netto [zł]
35-200-0040-000	1 20	101,88

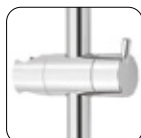

TS-4023

ROBERTO
dźwążek prysznicowy
dł. 64cm

(I) GRUPA RABATOWA

indeks	pakow. ☐ ☐	cena netto [zł]
35-200-0039-000	1 20	87,98

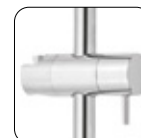

NA-1112PD**ZANZIBAR**

drążek prysznicowy z mydelniczką

I GRUPA RABATOWA

indeks	pakow.	cena netto [zł]
35-200-0015-000	1 10	93,15

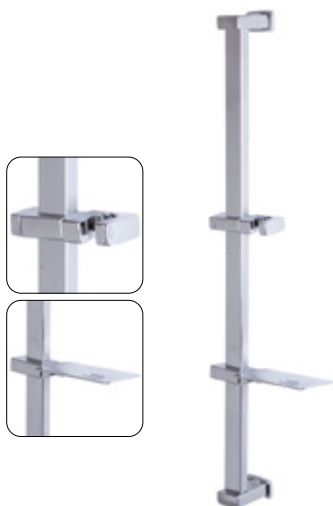
**NA123WD****PASJA**

Drążek wygięty z półką

I GRUPA RABATOWA

NEXE
new line

indeks	pakow.	cena netto [zł]
35-200-0016-000	1 20	91,60

**R10N**

Ramię prysznicowe dla zestawów podtynkowych z deszczownią

N GRUPA RABATOWA

NEXE
new line

indeks	pakow.	cena netto [zł]
36-107-0000-000	1 1	264,82

Produkt dostępny
do wyczerpania zapasów**BR9015****KORAL**

uchwyt punktowy prysznicowy

I GRUPA RABATOWA

indeks	pakow.	cena netto [zł]
35-200-0044-000	1 500	7,43

**BR-9005M****KRAB**

uchwyt punktowy prysznicowy

I GRUPA RABATOWA

indeks	pakow.	cena netto [zł]
35-200-0018-000	1 100	24,77

**BR-9009****LANGUSTA**

uchwyt punktowy prysznicowy z przysawką

I GRUPA RABATOWA

indeks	pakow.	cena netto [zł]
35-200-0028-000	1 100	36,69

Produkt dostępny
do wyczerpania zapasów

BR9008**RAK**
uchwyt punktowy prysznicowy**I** GRUPA RABATOWA

indeks	pakow. ☐ ☐	cena netto [zł]
35-200-0019-000	1 200	7,73

**HS-019**Wąż prysznicowy wzmocniony
½" x ½"**I** GRUPA RABATOWA

indeks	wąż [cm]	pakow. ☐ ☐	cena netto [zł]
35-400-1200-000	120	1 60	23,44
35-400-1500-000	150	1 60	25,42
35-400-1750-000	175	1 60	28,37
35-400-2000-000	200	1 60	32,23

**P9**

Uchwyt punktowy

N GRUPA RABATOWA**NEXE**
new line

indeks	pakow. ☐ ☐	cena netto [zł]
36-103-0000-000	1 100	31,00

**HS-020**Wąż prysznicowy elastyczny -
rozciągliwy ½"x½"**I** GRUPA RABATOWA

indeks	wąż [cm]	pakow. ☐ ☐	cena netto [zł]
35-401-1200-000	120-150	1 50	38,65
35-401-1500-000	150-180	1 30	45,23
35-401-1750-000	175-210	1 50	46,12

**R10**Uchwyt punktowy z ruchomą
końcówką**N** GRUPA RABATOWA**NEXE**
new line

indeks	pakow. ☐ ☐	cena netto [zł]
36-103-0000-003	1 100	26,55

**P4CM**

Wąż prysznicowy

**N** GRUPA RABATOWA**NEXE**
new line

indeks	wąż [cm]	pakow. ☐ ☐	cena netto [zł]
36-117-0150-003	150	1 50	44,60



P4S

Wąż prysznicowy

(N) GRUPA RABATOWA**NEXE**
new line

indeks	wąż [cm]	pakow. 	cena netto [zł]
36-115-0150-008	150	1 50	44,60

**P19CM**

Wąż prysznicowy

(N) GRUPA RABATOWA**NEXE**
new line

indeks	wąż [cm]	pakow. 	cena netto [zł]
36-116-0150-003	150	1 50	35,00

**HS-018**Wąż do baterii z wyjmowaną
wylewką, M15x1 x 1/2"**(I)** GRUPA RABATOWA

indeks	wąż [cm]	pakow. 	cena netto [zł]
35-402-1200-100	120	1 50	22,59

**NA-12H**Wąż prysznicowy 1/2" x 1/2"
„Bamboo”**(I)** GRUPA RABATOWA

indeks	wąż [cm]	pakow. 	cena netto [zł]
35-402-1500-000	150	1 60	23,56

Produkt dostępny
do wyczerpania zapasów**BT-9009****LANGUSTA**
zawieszanie do ręcznika
z przyssawką**(I)** GRUPA RABATOWA

indeks	pakow. 	cena netto [zł]
35-308-0000-300	1 10	90,95

Produkt dostępny
do wyczerpania zapasów**BS-9009****LANGUSTA**
mydelniczka z przyssawką**(I)** GRUPA RABATOWA

indeks	pakow. 	cena netto [zł]
35-310-0000-000	1 50	57,89

Produkt dostępny
do wyczerpania zapasów



BPK-9009**LANGUSTA**zawieszenie do papieru
toaletowego z przyssawką
 GRUPA RABATOWA

indeks	pakow.  	cena netto ^[zł]
35-308-0000-100	1 20	66,14

Produkt dostępny
do wyczerpania zapasów**BPS-9009****LANGUSTA**zawieszenie do papieru
toaletowego z przyssawką
 GRUPA RABATOWA

indeks	pakow.  	cena netto ^[zł]
35-308-0000-200	1 50	52,57



Produkt dostępny
do wyczerpania zapasów**BPR-9009****LANGUSTA**zawieszenie do ręcznika
z przyssawką
 GRUPA RABATOWA

indeks	pakow.  	cena netto ^[zł]
35-308-0000-000	1 20	66,14



Produkt dostępny
do wyczerpania zapasów**BB-9009****LANGUSTA**

szczotka do WC z przyssawką



 GRUPA RABATOWA

indeks	pakow.  	cena netto ^[zł]
35-309-0000-000	1 10	99,21

Produkt dostępny
do wyczerpania zapasów**BS-9009/1****LANGUSTA**adapter do akcesoriów
z przyssawką do nierównych
powierzchni
 GRUPA RABATOWA

indeks	pakow.  	cena netto ^[zł]
35-311-0000-000	1 400	10,04

Produkt dostępny
do wyczerpania zapasów**BD-9009/1****LANGUSTA**adapter do drążka BD-9009
do nierównych powierzchni
 GRUPA RABATOWA

indeks	pakow.  	cena netto ^[zł]
35-311-0000-100	1 200	10,04

Produkt dostępny
do wyczerpania zapasów



AKCESORIA/ CZĘŚCI DO BATERII 124-127

Perlatory	125
Przedłużki i pokrętła	126
Głowice do baterii	126
Wylewki do baterii	127
Inne akcesoria	127

P1**NEXE ECO**
perlator do baterii**NEXE**
new line

indeks	wielkość	pakowanie		cena netto [zł]
36-114-0001-000	M24 x GZ1"	1	250	16,00



GRUPA RABATOWA

P2**NEXE ECO**
perlator do baterii**NEXE**
new line

indeks	wielkość	pakowanie		cena netto [zł]
36-114-0000-000	M22 x GW1"	1	250	16,00



GRUPA RABATOWA

08

Perlator do baterii



indeks	wielkość	pakowanie		cena netto [zł]
35-301-0000-000	M22 x GW1"	25	2000	4,41



GRUPA RABATOWA

09

Perlator do baterii



indeks	wielkość	pakowanie		cena netto [zł]
35-301-0006-000	M24 x GZ1"	100	1000	4,41



GRUPA RABATOWA

10

Perlator do baterii



indeks	wielkość	pakowanie		cena netto [zł]
35-301-0001-000	M28 x GZ1"	10	1000	8,82



GRUPA RABATOWA

NA-PR1P**TUKAN**
perlator długi z redukcją
2-funkcyjny długi wąż tworzywowy

indeks	pakowanie		cena netto [zł]
35-301-0003-000	1	100	15,85



GRUPA RABATOWA

NA-PR2**PELIKAN**
perlator długi z redukcją
2-funkcyjny długi wąż chromowany

indeks	pakowanie		cena netto [zł]
35-301-0004-000	1	100	19,97



GRUPA RABATOWA

NA-PR3P**ARA**
perlator z redukcją 2-funkcyjny
na przegubie krótkim

indeks	pakowanie		cena netto [zł]
35-301-0005-000	1	100	15,85



GRUPA RABATOWA

BR9045**KOLIBER**

Perlator krótki z redukcją
2-funkcyjny



indeks	pakowanie		cena netto [zł]
35-301-0002-000	1	100	10,59

GRUPA RABATOWA

PHA-351

Przedłużka pod baterię
naścienną mosiężna
chromowana WZ

**PERFEKT²SYSTEM**

indeks	wielkość	PN	Tmax	pakowanie		cena netto [zł]
07-351-0200-000	¾"	16	+180°C	20	180	17,71

GRUPA RABATOWA

H511

Pokrętko baterii
2-uchwytowych PRIMULA



indeks	wielkość	kolor	pakowanie		cena netto [zł]
35-300-0000-000	½" x ¾"	niebieski lub czerwony	50	400	7,10

GRUPA RABATOWA

POLONIA

POLONIA
głowica do baterii
2-uchwytowych



indeks	wielkość	typ	pakowanie		cena netto [zł]
35-302-0000-010	¾"	dziewczynka	50	400	7,07
35-302-0000-000	½"	dziewczynka	30	240	9,47
35-302-0000-100	½"	chłopiec	30	240	9,47

GRUPA RABATOWA

10C/10N

Głowica ceramiczna prawa
do baterii 2-uchwytowych



indeks	typ	kolor	pakowanie		cena netto [zł]
35-302-0001-000	prawa	czerwona	1	400	14,03
35-302-0001-100	prawa	niebieska	1	400	14,03

GRUPA RABATOWA

C201/C202

Głowica ceramiczna
do baterii 1-uchwytowych



indeks	wielkość	typ	symbol	pakowanie		cena netto [zł]
35-302-0002-350	35	niska	C201	1	100	16,55
35-302-0003-350	35	wysoka	C202	1	100	16,55
35-302-0002-400	40	niska	C201	1	100	16,90
35-302-0003-400	40	wysoka	C202	1	100	16,90

GRUPA RABATOWA

07

Mimośród do baterii



indeks	wielkość	pakowanie		cena netto [zł]
35-303-0000-000	½" x ¾"	2	320	13,32

GRUPA RABATOWA

WL1

Wylewka płaska do baterii,
wygięta, nakrętki 3/4"



indeks	wielkość	typ	nakrętki	pakowanie		cena netto [zł]
35-304-0000-300	14 cm	wygięta	3/4"	1	100	33,16
35-304-0000-100	16 cm	wygięta	3/4"	1	100	35,07
35-304-0000-200	22 cm	wygięta	3/4"	1	100	44,66

I GRUPA RABATOWA

WL2C

Wylewka rurkowa
do baterii



indeks	wielkość	typ	nakrętki	pakowanie		cena netto [zł]
35-304-0000-400	16 cm	C	1/2"	1	50	27,13
35-304-0000-500	25 cm	C	1/2"	1	50	30,29

I GRUPA RABATOWA

WL2S

Wylewka rurkowa
do baterii



indeks	wielkość	typ	nakrętki	pakowanie		cena netto [zł]
35-304-0000-600	16 cm	S	1/2"	1	50	27,13
35-304-0000-700	25 cm	S	1/2"	1	50	30,29

I GRUPA RABATOWA

DIV-1

Przełącznik mechaniczny
do baterii wannowej



indeks	pakowanie		cena netto [zł]
35-306-0000-000	50	400	14,67

I GRUPA RABATOWA

UNIWERSALNE ZASTOSOWANIE, NIEZALEŻNIE OD CIŚNIENIA W INSTALACJI

PAD-1

Stabilizator do mocowania
baterii stojących



indeks	pakowanie		cena netto [zł]
35-307-0000-000	1	500	5,26

I GRUPA RABATOWA

A.695/09004W

Zaślepka



indeks	pakowanie		cena netto [zł]
98-035-0001-000	100	1000	13,70

E GRUPA RABATOWA

A.695/09004C

Zaślepka



indeks	pakowanie		cena netto [zł]
98-035-0002-000	100	1000	14,20

E GRUPA RABATOWA



Możliwość rozciągnięcia
i kształtowania

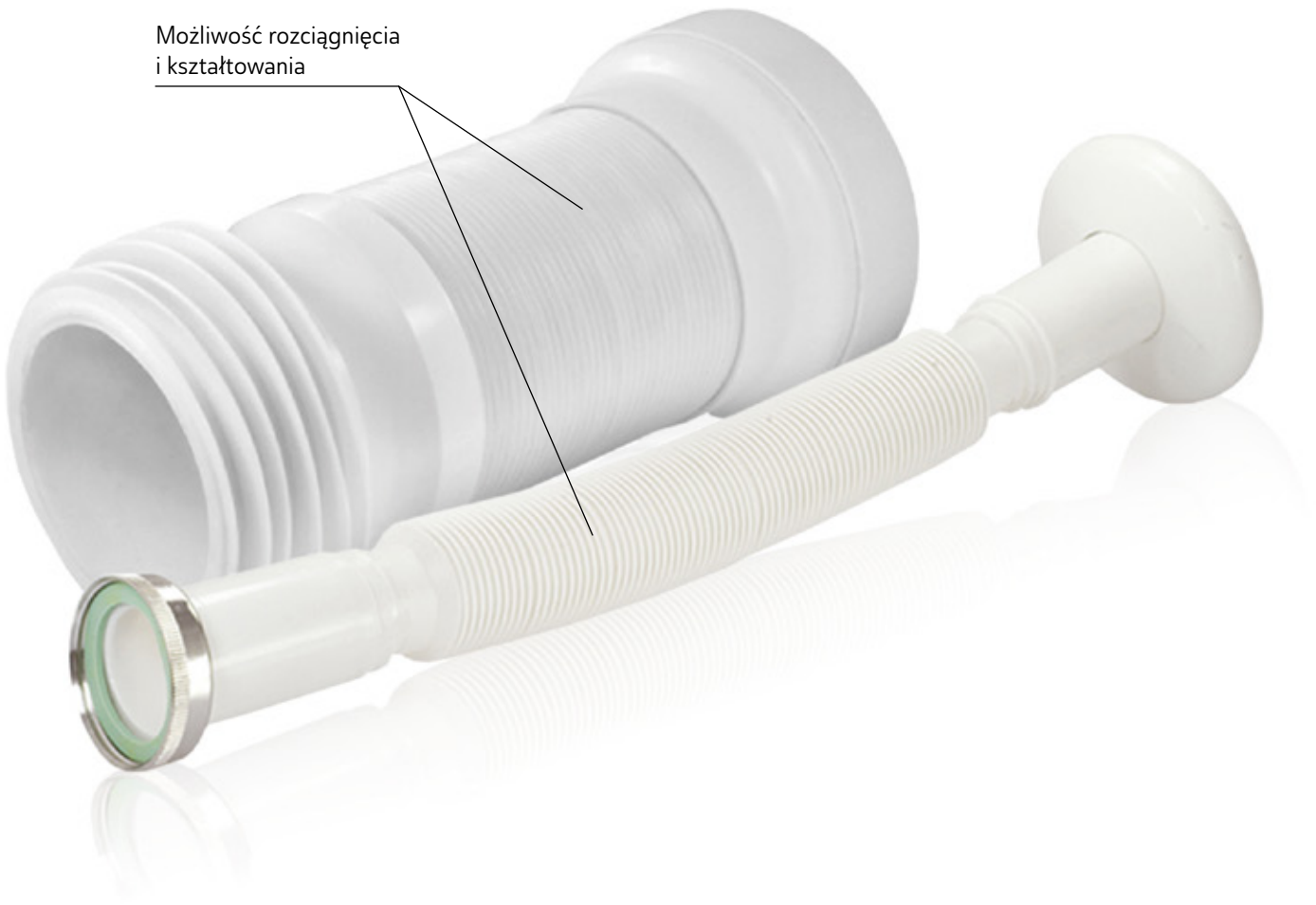

ARMATURA SANITARNA 128-129

Przyłącza

129

Wężę do pralki

129

969

Przyłącze elastyczne ABS



indeks	wielkość	pakowanie		cena netto [zł]
40-969-3232-000	1¼ x 32	1	100	8,13
40-969-4050-000	1½ x 40/50	1	100	9,78

(E) GRUPA RABATOWA

991

Przyłącze rozciągliwe WC



indeks	pakowanie		cena netto [zł]
40-991-0000-000	1	30	29,79

(E) GRUPA RABATOWA

997

Łącznik mimośrodowy WC



indeks	pakowanie		cena netto [zł]
40-997-0000-000	1	60	9,83

(E) GRUPA RABATOWA

Produkt dostępny do wyczerpania zapasów

998

Łącznik prosty WC



indeks	pakowanie		cena netto [zł]
40-998-0000-000	1	60	9,83

(E) GRUPA RABATOWA

Produkt dostępny do wyczerpania zapasów

96C/96W

Syfon do pralki natynkowy



indeks	kolor	pakowanie		cena netto [zł]
40-961-0000-000	chrom	1	100	15,98
40-960-0000-000	biały	1	100	11,48

(E) GRUPA RABATOWA

291

Wąż zasilający do pralki ¾" x ¾"



indeks	wielkość	pakowanie		cena netto [zł]
35-403-1500-000	150	1	10	19,20
35-403-2000-000	200	1	10	19,39
35-403-2500-000	250	1	10	22,71
35-403-3000-000	300	1	10	25,19

(C) GRUPA RABATOWA

306

Wąż odprowadzający do pralki



indeks	wielkość	pakowanie		cena netto [zł]
35-404-1500-000	150	1	1	12,08
35-405-2000-000	200	1	1	13,90
35-405-2500-000	250	1	1	19,13
35-404-3000-000	300	1	1	16,32

(C) GRUPA RABATOWA

WARUNKI RABATÓW

grupa	
A	
B	
C	
D	
E	
G	
H	
HS	
I	
J	
K	
K1	
K2	
K3	
L	
N	
P	
Z	



ZŁOTY LAUR KONSUMENTA

w kategorii Producent i importer
branży instalacyjno-grzewczej, łazienkowej i sanitarnej

LAUR KONSUMENTA - ODKRYCIE ROKU

w kategorii Polska jakość branży budowlanej.
Jakość produktów, usług i obecność w świadomości
konsumentów

Niniejszy cennik nie stanowi oferty w rozumieniu przepisów Kodeksu Cywilnego i jest tylko informacją wstępną. Do zawarcia indywidualnej umowy może dojść wyłącznie po uzgodnieniu istotnych jej postanowień. Równocześnie Producent zastrzega sobie prawo do wprowadzenia zmian i modyfikacji cen oraz danych technicznych produktów wymienionych w niniejszym Cenniku, a także zmian wynikających z mogących wystąpić błędów lub pomyłek.

Zdjęcia produktów mają charakter poglądowy.
Do podanych cen netto należy doliczyć podatek VAT w wysokości 23%.

Perfexim spółka z ograniczoną odpowiedzialnością
ul. Samotna 2, 61-441 Poznań, Polska