

# PERFEXIM

PERFEKT<sup>?</sup> SYSTEM

NEXE  
new line

# CEMNIK 2024



[www.perfexim.pl](http://www.perfexim.pl)  
Cennik ważny od 15.03.2024

# PERFEXIM

## LEGENDA



jakość marki  
**PERFEKT**SYSTEM



centralne  
ogrzewanie



lat gwarancji



chłodnictwo



aprobata  
techniczna



glikol



wytrzymałość



powietrze



mosiądz



woda ciepła  
i zimna



atest  
higieniczny



znak  
budowlany



### ZŁOTY LAUR KONSUMENTA

w kategorii Producent  
i importer branży instalacyjno-  
grzewczej, łazienkowej i sanitarnej

### LAUR KONSUMENTA - ODKRYCIE ROKU

w kategorii Polska jakość  
branży budowlanej. Jakość produktów,  
usług i obecność w świadomości  
konsumentów

# SPIIS TREŚCI

## ARMATURA WODNA

5-30

Kurki kulowe	5
Filtry do wody	11
Zawory zwrotne	12
Zasuwy	13
Zawory antyskażeniowe	13
Zawory przepływowe	13
Zawory zwrotne kulowe różnicowe	14
Zawory żeliwne	14
Kurki i zawory czerpalne	14
Złączki mosiężne wzmocnione	16
Śrubunki mosiężne wzmocnione	19
Złączki mosiężne	20
Śrubunki mosiężne	22
Śrubunki wodomierza	23
Konsole wodomierza	23
Złączki mosiężne chromowane	24
Śrubunki mosiężne chromowane	25
Taśmy teflonowe	26
Kurki i zawory podłączeniowe	26
Przyłącza elastyczne	28

## ARMATURA GAZOWA

32

Kurki kulowe	33
Filtry	33
Przyłącza	33

## ARMATURA CENTRALNEGO OGRZEWANIA

34-54

System antyzamrozeniowy	35
Komplety / głowice termostatyczne	35
Zawory grzejnikowe	39
Zawory bezpieczeństwa	42
Pompy obiegowe	43
Rozdzielacze, osprzęt rozdzielaczy	44
Zawory odpowietrzające	53
Automatyka ogrzewania	54
Uchwyty do bojlerów	54

## SYSTEMY RUROWE WIELOWARSTWOWE

55-67

Rury PERT	56
Rury PEX	56
Złączki zaprasowywane	57
Złączki skręcane	63
System montażowy	66
Narzędzia	67

## RURA MIEDZIANA

72-74

Rury twarde i miękkie	73
-----------------------	----

## GRZEJNIKI PŁYTKOWE I ALUMINIOWE

75-80

Grzejniki płytowe C i V	76
Grzejniki aluminiowe	78
Osprzęt grzejników aluminiowych	78
Głowice termostatyczne	78
Osprzęt grzejników stalowych	80

## BATERIE PODTYNKOWE

81-88

Baterie podtynkowe	82
Akcesoria do baterii podtynkowych	86

## ARMATURA KUCHENNA I ŁAZIENKOWA

89-123

Baterie WEGA	90
Baterie RENO	92
Baterie kuchenne i łazienkowe	94
głowica 40	94
głowica 35	98
Baterie ciśnieniowe	108
Syfony	108
Korki zamykające	109
Komplety prysznicowe	114
Słuchawki z deszczownicą	115
Słuchawki	116
Drażki prysznicowe	119
Uchwyty punktowe	120
Wężę prysznicowe	121
Akcesoria łazienkowe z przysawką	122

## AKCESORIA / CZĘŚCI DO BATERII

124-127

Perlatory	125
Przedłużki i pokrętła	126
Głowice do baterii	126
Wylewki do baterii	127
Inne akcesoria	127

## ARMATURA SANITARNA

128-129

Przyłącza	129
Wężę do pralki	129

LAT  
**10**  
GWARANCJI

Pewna, kompletna  
i różnorodna armatura wodna

# PERFEXIM

CENNIK ARMATURA 2024



PERFEKT<sup>?</sup>SYSTEM

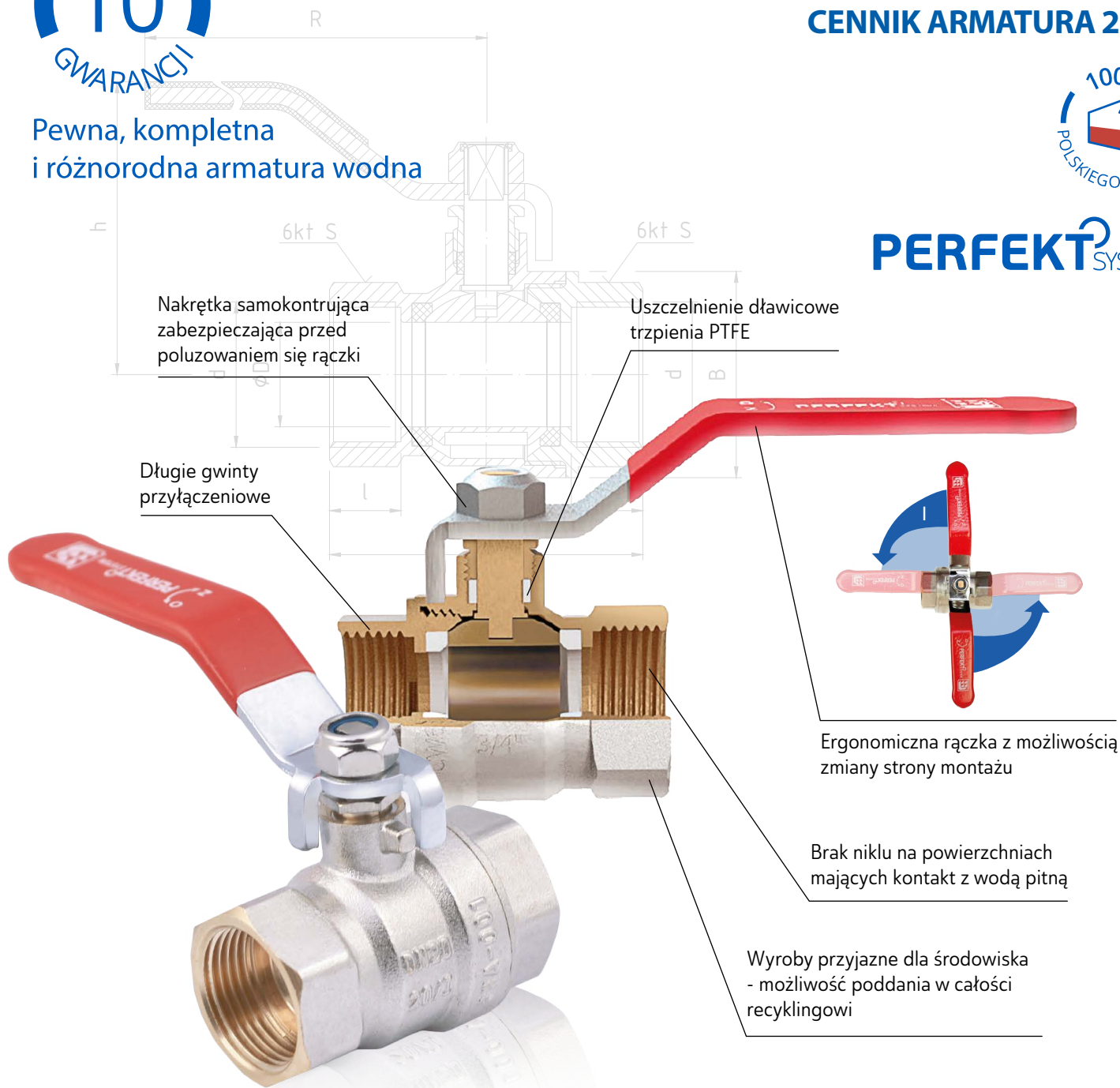

# ARMATURA WODNA

## 5-30

Kurki kulowe	5
Filtry do wody	11
Zawory zwrotne	12
Zasuwy	13
Zawory antyskażeniowe	13
Zawory przepływowe	13
Zawory zwrotne kulowe różnicowe	14
Zawory żeliwne	14
Kurki i zawory czerpalne	14
Złączki mosiężne wzmocnione	16
Śrubunki mosiężne wzmocnione	19
Złączki mosiężne	20
Śrubunki mosiężne	22
Śrubunki wodomierza	23
Konsole wodomierza	23
Złączki mosiężne chromowane	24
Śrubunki mosiężne chromowane	25
Taśmy teflonowe	26
Kurki i zawory podłączeniowe	26
Przyłącza elastyczne	28

## PHA-001

PERFEKT SYSTEM  
Kurek kulowy WW

(K) GRUPA RABATOWA

PERFEKT<sup>2</sup> SYSTEM

indeks	wielkość	PN	rodzaj uchwytu	kolor uchwytu	Tmax	pakowanie		cena netto [zł]
00-001-0100-000	3/8"	30	rączka	czerwony	+150°C	10	200	17,67
00-001-0150-000	1/2"	30	rączka	czerwony	+150°C	15	150	23,83
00-001-0200-000	3/4"	30	rączka	czerwony	+150°C	10	100	34,73
00-001-0250-000	1"	30	rączka	czerwony	+150°C	6	60	56,17
00-001-0320-000	1 1/4"	30	rączka	czerwony	+150°C	4	40	88,96
00-001-0400-000	1 1/2"	30	rączka	czerwony	+150°C	4	32	134,15
00-001-0500-000	2"	30	rączka	czerwony	+150°C	2	20	202,13
00-001-0650-000	2 1/2"	30	rączka	czerwony	+150°C	2	10	426,63
00-001-0800-000	3"	30	rączka	czerwony	+150°C	2	4	586,05
00-001-1000-000	4"	30	rączka	czerwony	+150°C	2	4	1032,88

## PHA-001

PERFEKT SYSTEM  
Kurek kulowy WW

(K) GRUPA RABATOWA

PERFEKT<sup>2</sup> SYSTEM

indeks	wielkość	PN	rodzaj uchwytu	kolor uchwytu	Tmax	pakowanie		cena netto [zł]
00-001-0100-001	3/8"	30	rączka	niebieski	+150°C	10	200	17,67
00-001-0150-001	1/2"	30	rączka	niebieski	+150°C	15	150	23,83
00-001-0200-001	3/4"	30	rączka	niebieski	+150°C	10	100	34,73
00-001-0250-001	1"	30	rączka	niebieski	+150°C	6	60	56,17
00-001-0320-001	1 1/4"	30	rączka	niebieski	+150°C	4	40	88,96
00-001-0400-001	1 1/2"	30	rączka	niebieski	+150°C	4	32	134,15
00-001-0500-001	2"	30	rączka	niebieski	+150°C	2	20	202,13
00-001-0650-001	2 1/2"	30	rączka	niebieski	+150°C	2	10	426,63
00-001-0800-001	3"	30	rączka	niebieski	+150°C	2	4	586,05
00-001-1000-001	4"	30	rączka	niebieski	+150°C	2	4	1032,88

## PHA-002

PERFEKT SYSTEM  
Kurek kulowy WW

(K) GRUPA RABATOWA

dostępny w III kwartale 2024

PERFEKT<sup>2</sup> SYSTEM

indeks	wielkość	PN	rodzaj uchwytu	kolor uchwytu	Tmax	pakowanie		cena netto [zł]
00-002-0150-000	1/2"	30	motyl	czerwony	+150°C	15	150	24,70
00-002-0200-000	3/4"	30	motyl	czerwony	+150°C	10	100	33,95
00-002-0250-000	1"	30	motyl	czerwony	+150°C	6	60	55,47
00-002-0320-000	1 1/4"	30	motyl	czerwony	+150°C	4	40	87,20

## PHA-002

PERFEKT SYSTEM  
Kurek kulowy WW

(K) GRUPA RABATOWA

PERFEKT<sup>2</sup> SYSTEM

indeks	wielkość	PN	rodzaj uchwytu	kolor uchwytu	Tmax	pakowanie		cena netto [zł]
00-002-0150-001	1/2"	30	motyl	niebieski	+150°C	15	150	24,70
00-002-0200-001	3/4"	30	motyl	niebieski	+150°C	10	100	33,95
00-002-0250-001	1"	30	motyl	niebieski	+150°C	6	60	55,47

## PHA-002C

PERFEKT SYSTEM  
Kurek kulowy z podejściem do czujnika M10x1

(K) GRUPA RABATOWA

PERFEKT<sup>2</sup> SYSTEM

indeks	wielkość	PN	rodzaj uchwytu	kolor uchwytu	Tmax	pakowanie		cena netto [zł]
00-002-0150-003	1/2"	30	motyl	czerwony	+150°C	10	200	32,82
00-002-0200-003	3/4"	30	motyl	czerwony	+150°C	15	150	45,62

## PHA-003

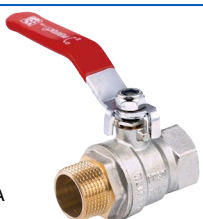
PERFEKT SYSTEM  
Kurek kulowy WZ

(K) GRUPA RABATOWA

dostępny w III kwartale 2024

PERFEKT<sup>2</sup> SYSTEM

indeks	wielkość	PN	rodzaj uchwytu	kolor uchwytu	Tmax	pakowanie		cena netto [zł]
00-003-0150-000	1/2"	30	rączka	czerwony	+150°C	15	150	26,05
00-003-0200-000	3/4"	30	rączka	czerwony	+150°C	10	100	37,88
00-003-0250-000	1"	30	rączka	czerwony	+150°C	6	60	63,54
00-003-0320-000	1 1/4"	30	rączka	czerwony	+150°C	4	40	96,10

## PHA-003

PERFEKT SYSTEM  
Kurek kulowy WZ

(K) GRUPA RABATOWA

PERFEKT<sup>2</sup> SYSTEM

indeks	wielkość	PN	rodzaj uchwyty	kolor uchwyty	Tmax	pakowanie		cena netto [zł]
<b>00-003-0150-001</b>	½"	30	rączka	niebieski	+150°C	15	150	<b>26,05</b>
<b>00-003-0200-001</b>	¾"	30	rączka	niebieski	+150°C	10	100	<b>37,88</b>
<b>00-003-0250-001</b>	1"	30	rączka	niebieski	+150°C	6	60	<b>63,54</b>

## PHA-004

PERFEKT SYSTEM  
Kurek kulowy WZ

dostępny w III kwartale 2024

(K) GRUPA RABATOWA

PERFEKT<sup>2</sup> SYSTEM

indeks	wielkość	PN	rodzaj uchwyty	kolor uchwyty	Tmax	pakowanie		cena netto [zł]
<b>00-004-0150-000</b>	½"	30	motyl	czerwony	+150°C	15	150	<b>25,32</b>
<b>00-004-0200-000</b>	¾"	30	motyl	czerwony	+150°C	10	100	<b>35,93</b>
<b>00-004-0250-000</b>	1"	30	motyl	czerwony	+150°C	6	60	<b>59,05</b>
<b>00-004-0320-000</b>	1¼"	30	motyl	czerwony	+150°C	4	40	<b>88,40</b>

## PHA-004

PERFEKT SYSTEM  
Kurek kulowy WZ

(K) GRUPA RABATOWA

PERFEKT<sup>2</sup> SYSTEM

indeks	wielkość	PN	rodzaj uchwyty	kolor uchwyty	Tmax	pakowanie		cena netto [zł]
<b>00-004-0150-001</b>	½"	30	motyl	niebieski	+150°C	15	150	<b>25,32</b>
<b>00-004-0200-001</b>	¾"	30	motyl	niebieski	+150°C	10	100	<b>35,93</b>
<b>00-004-0250-001</b>	1"	30	motyl	niebieski	+150°C	6	60	<b>59,05</b>

## PHA-005

PERFEKT SYSTEM  
Kurek kulowy ze śrubunkiem

(K) GRUPA RABATOWA

PERFEKT<sup>2</sup> SYSTEM

indeks	wielkość	PN	rodzaj uchwyty	kolor uchwyty	Tmax	pakowanie		cena netto [zł]
<b>00-005-0150-000</b>	½"	30	motyl	czerwony	+150°C	10	120	<b>28,99</b>
<b>00-005-0200-000</b>	¾"	30	motyl	czerwony	+150°C	10	100	<b>45,40</b>
<b>00-005-0250-000</b>	1"	30	motyl	czerwony	+150°C	6	60	<b>77,62</b>
<b>00-005-0320-000</b>	1¼"	30	motyl	czerwony	+150°C	4	24	<b>113,14</b>

## PHA-005/SM

PERFEKT SYSTEM  
Kurek kulowy ze śrubunkiem

(K) GRUPA RABATOWA

Produkt dostępny do wyczerpania zapasów

PERFEKT<sup>2</sup> SYSTEM

indeks	wielkość	PN	rodzaj uchwyty	kolor uchwyty	Tmax	pakowanie		cena netto [zł]
<b>00-005-0150-200</b>	½"	30	motyl	czerwony	+150°C	10	120	<b>28,99</b>
<b>00-005-0200-200</b>	¾"	30	motyl	czerwony	+150°C	10	100	<b>45,40</b>
<b>00-005-0250-200</b>	1"	30	motyl	czerwony	+150°C	6	60	<b>77,62</b>

## PHA-005/R

PERFEKT SYSTEM  
Kurek kulowy ze śrubunkiem

(K) GRUPA RABATOWA

dostępny w III kwartale 2024

PERFEKT<sup>2</sup> SYSTEM

indeks	wielkość	PN	rodzaj uchwyty	kolor uchwyty	Tmax	pakowanie		cena netto [zł]
<b>00-005-0150-100</b>	½"	30	rączka	czerwony	+150°C	10	120	<b>28,99</b>
<b>00-005-0200-100</b>	¾"	30	rączka	czerwony	+150°C	10	100	<b>45,40</b>
<b>00-005-0250-100</b>	1"	30	rączka	czerwony	+150°C	6	60	<b>77,62</b>
<b>00-005-0320-100</b>	1¼"	30	rączka	czerwony	+150°C	4	24	<b>113,14</b>

## PHA-006

PERFEKT SYSTEM  
Kurek kulowy z filtrem skośnym

(K) GRUPA RABATOWA

PERFEKT<sup>2</sup> SYSTEM

indeks	wielkość	PN	rodzaj uchwyty	kolor uchwyty	Tmax	pakowanie		cena netto [zł]
<b>01-006-0150-000</b>	½"	30	rączka	czerwony	+150°C	8	80	<b>37,89</b>
<b>01-006-0200-000</b>	¾"	30	rączka	czerwony	+150°C	6	60	<b>63,46</b>
<b>01-006-0250-000</b>	1"	30	rączka	czerwony	+150°C	4	40	<b>93,19</b>

## PHA-007

**PERFEKT SYSTEM**  
Kurek kulowy  
ze śrubunkiem

PERFEKT<sup>2</sup>SYSTEM

indeks	wielkość	PN	rodzaj uchwyty	kolor uchwyty	Tmax	pakowanie		cena netto [zł]
00-007-0150-002	½"	30	motylek	czerwony	+140°C	12	120	<b>34,03</b>
00-007-0200-002	¾"	30	motylek	czerwony	+140°C	8	80	<b>52,26</b>
00-007-0250-002	1"	30	motylek	czerwony	+140°C	4	40	<b>88,16</b>



(K) GRUPA RABATOWA

## PHA-007/O

**PERFEKT SYSTEM**  
Kurek kulowy  
z obrotową nakrętką  
z dławikiem



**NOWOŚĆ**

PERFEKT<sup>2</sup>SYSTEM

indeks	wielkość	PN	rodzaj uchwyty	kolor uchwyty	Tmax	pakowanie		cena netto [zł]
00-007-0150-001	½"	30	motylek	czerwony	+140°C	12	144	<b>27,00</b>
00-007-0200-001	¾"	30	motylek	czerwony	+140°C	10	100	<b>39,00</b>
00-007-0250-001	1"	30	motylek	czerwony	+140°C	6	60	<b>68,00</b>
00-007-0320-001	1¼"	30	motylek	czerwony	+140°C	4	32	<b>102,00</b>



(K) GRUPA RABATOWA

Produkt dostępny w II kwartale 2024

## PHA-007/R

**PERFEKT SYSTEM**  
Kurek kulowy  
ze śrubunkiem

PERFEKT<sup>2</sup>SYSTEM

indeks	wielkość	PN	rodzaj uchwyty	kolor uchwyty	Tmax	pakowanie		cena netto [zł]
00-007-0150-102	½"	30	rączka	czerwony	+140°C	10	100	<b>34,03</b>
00-007-0200-102	¾"	30	rączka	czerwony	+140°C	6	60	<b>52,26</b>
00-007-0250-102	1"	30	rączka	czerwony	+140°C	4	40	<b>88,16</b>



(K) GRUPA RABATOWA

## PHA-007A

**PERFEKT SYSTEM**  
Kurek kulowy  
ze śrubunkiem z gwintem  
samoszczelniającym

PERFEKT<sup>2</sup>SYSTEM

indeks	wielkość	PN	rodzaj uchwyty	kolor uchwyty	Tmax	pakowanie		cena netto [zł]
00-007-0250-003	1"	30	motylek	czerwony	+140°C	4	40	<b>89,98</b>



(K) GRUPA RABATOWA

## PHA-008

**PERFEKT SYSTEM**  
Kurek kulowy z zaworem  
spustowym

PERFEKT<sup>2</sup>SYSTEM

indeks	wielkość	PN	rodzaj uchwyty	kolor uchwyty	Tmax	pakowanie		cena netto [zł]
00-008-0150-002	½"	30	rączka	czerwony	+140°C	8	80	<b>38,09</b>
00-008-0200-002	¾"	30	rączka	czerwony	+140°C	6	60	<b>48,39</b>
00-008-0250-002	1"	30	rączka	czerwony	+140°C	4	40	<b>72,06</b>



(K) GRUPA RABATOWA

## PHA-010

**PERFEKT SYSTEM**  
Kurek kulowy kątowy  
ze śrubunkiem

PERFEKT<sup>2</sup>SYSTEM

indeks	wielkość	PN	rodzaj uchwyty	kolor uchwyty	Tmax	pakowanie		cena netto [zł]
00-010-0150-000	½"	30	motyl	czerwony	+140°C	10	80	<b>37,45</b>
00-010-0200-000	¾"	30	motyl	czerwony	+140°C	6	40	<b>54,98</b>
00-010-0250-000	1"	30	motyl	czerwony	+140°C	5	40	<b>90,76</b>
00-010-0320-000	1¼"	30	motyl	czerwony	+140°C			



dostępny w III kwartale 2024

(K) GRUPA RABATOWA

## PHA-010A

**PERFEKT SYSTEM**  
Kurek kulowy kątowy  
ze śrubunkiem z gwintem  
samoszczelniającym

PERFEKT<sup>2</sup>SYSTEM

indeks	wielkość	PN	rodzaj uchwyty	kolor uchwyty	Tmax	pakowanie		cena netto [zł]
00-010-0250-002	1"	30	motyl	czerwony	+140°C	5	40	<b>92,66</b>
00-010-0250-003	1"	30	motyl	niebieski	+140°C	5	40	<b>92,66</b>



(K) GRUPA RABATOWA

**PHA-010/O****PERFEKT SYSTEM**

Kurek kulowy kątowny z obrotową nakrętką

**NOWOŚĆ****PERFEKT SYSTEM**

indeks	wielkość	PN	rodzaj uchwyty	kolor uchwyty	Tmax	pakowanie		cena netto [zł]
<b>00-010-0150-001</b>	½"	30	motyl	czerwony	+140°C	12	120	<b>33,40</b>
<b>00-010-0200-001</b>	¾"	30	motyl	czerwony	+140°C	8	80	<b>50,00</b>
<b>00-010-0250-001</b>	1"	30	motyl	czerwony	+140°C	6	48	<b>74,00</b>
<b>00-010-0320-001</b>	1¼"	30	motyl	czerwony	+140°C	4	24	<b>120,00</b>

**(K)** GRUPA RABATOWA

Produkt dostępny w II kwartale 2024

**RN-PHA**

Rączka do kurków kulowych PHA-001 i PHA-003, z ergonomiczną rączką, z etykietką na kurku

**PERFEKT SYSTEM**

indeks	kolor	indeks	kolor	wielkość	pakowanie		cena netto [zł]
<b>01-900-1001-150</b>	czerwony	<b>01-900-1011-150</b>	niebieski	½"	1	1	<b>2,00</b>
<b>01-900-1001-200</b>	czerwony	<b>01-900-1011-200</b>	niebieski	¾"	1	1	<b>2,42</b>
<b>01-900-1001-250</b>	czerwony	<b>01-900-1011-250</b>	niebieski	1"	1	1	<b>4,11</b>
<b>01-900-1001-320</b>	czerwony	<b>01-900-1011-320</b>	niebieski	1¼"	1	1	<b>6,29</b>
<b>01-900-1001-400</b>	czerwony	<b>01-900-1011-400</b>	niebieski	1½"	1	1	<b>8,56</b>
<b>01-900-1001-500</b>	czerwony	<b>01-900-1011-500</b>	niebieski	2"	1	1	<b>12,85</b>

**(K)** GRUPA RABATOWA**MN-PHA**

Motyl do kurków kulowych PHA-002 i PHA-004 z etykietką na kurku

**PERFEKT SYSTEM**

indeks	kolor	indeks	kolor	wielkość	pakowanie		cena netto [zł]
<b>01-900-1010-150</b>	czerwony	<b>01-900-1012-150</b>	niebieski	½"	1	1	<b>2,00</b>
<b>01-900-1010-200</b>	czerwony	<b>01-900-1012-200</b>	niebieski	¾"	1	1	<b>2,42</b>
<b>01-900-1010-250</b>	czerwony	<b>01-900-1012-250</b>	niebieski	1"	1	1	<b>4,11</b>

**(K)** GRUPA RABATOWA**PHA-200/1****HUZAR**

kurek kulowy WW

**PERFEKT SYSTEM**

indeks	wielkość	PN	rodzaj uchwyty	kolor uchwyty	Tmax	pakowanie		cena netto [zł]
<b>00-006-0150-000</b>	½"	40	rączka	czarny	+180°C	10	90	<b>38,44</b>
<b>00-006-0200-000</b>	¾"	40	rączka	czarny	+180°C	10	60	<b>62,84</b>
<b>00-006-0250-000</b>	1"	40	rączka	czarny	+180°C	6	36	<b>96,34</b>
<b>00-006-0320-000</b>	1¼"	40	rączka	czarny	+180°C	4	24	<b>157,12</b>
<b>00-006-0400-000</b>	1½"	40	rączka	czarny	+180°C	2	18	<b>219,94</b>
<b>00-006-0500-000</b>	2"	40	rączka	czarny	+180°C	2	8	<b>368,64</b>

**(K)** GRUPA RABATOWA**PHA-200/2****HUZAR**

kurek kulowy WZ

**PERFEKT SYSTEM**

indeks	wielkość	PN	rodzaj uchwyty	kolor uchwyty	Tmax	pakowanie		cena netto [zł]
<b>00-007-0150-000</b>	½"	40	rączka	czarny	+180°C	10	90	<b>37,42</b>
<b>00-007-0200-000</b>	¾"	40	rączka	czarny	+180°C	10	60	<b>61,18</b>
<b>00-007-0250-000</b>	1"	40	rączka	czarny	+180°C	6	36	<b>93,79</b>

**(K)** GRUPA RABATOWA**PHA-200/3****HUZAR**

kurek kulowy WW

**PERFEKT SYSTEM**

indeks	wielkość	PN	rodzaj uchwyty	kolor uchwyty	Tmax	pakowanie		cena netto [zł]
<b>00-008-0150-000</b>	½"	40	motyl	czarny	+180°C	10	90	<b>36,71</b>
<b>00-008-0200-000</b>	¾"	40	motyl	czarny	+180°C	10	60	<b>60,27</b>
<b>00-008-0250-000</b>	1"	40	motyl	czarny	+180°C	6	36	<b>93,79</b>

**(K)** GRUPA RABATOWA**PHA-200/4****HUZAR**

kurek kulowy WZ

**PERFEKT SYSTEM**

indeks	wielkość	PN	rodzaj uchwyty	kolor uchwyty	Tmax	pakowanie		cena netto [zł]
<b>00-009-0150-000</b>	½"	40	motyl	czarny	+180°C	10	90	<b>37,42</b>
<b>00-009-0200-000</b>	¾"	40	motyl	czarny	+180°C	10	60	<b>61,18</b>
<b>00-009-0250-000</b>	1"	40	motyl	czarny	+180°C	6	36	<b>93,79</b>

**(K)** GRUPA RABATOWA

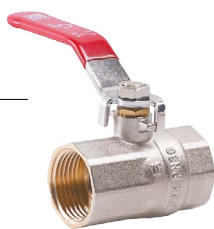

**KX01****KROS**  
kurek kulowy WW**L** GRUPA RABATOWA

indeks	wielkość	PN	rodzaj uchwyty	kolor uchwyty	Tmax	pakowanie		cena netto [zł]
<b>KX01-0150-000</b>	½"	30	rączka	czerwony	+130°C	15	150	<b>20,18</b>
<b>KX01-0200-000</b>	¾"	30	rączka	czerwony	+130°C	10	100	<b>29,37</b>
<b>KX01-0250-000</b>	1"	30	rączka	czerwony	+130°C	6	60	<b>46,26</b>
<b>KX01-0320-000</b>	1¼"	30	rączka	czerwony	+130°C	4	40	<b>74,17</b>
<b>KX01-0400-000</b>	1½"	30	rączka	czerwony	+130°C	4	32	<b>109,47</b>
<b>KX01-0500-000</b>	2"	30	rączka	czerwony	+130°C	2	20	<b>168,05</b>
<b>KX01-0650-000</b>	2½"	30	rączka	czerwony	+130°C	2	10	<b>342,11</b>

**KX02****KROS**  
kurek kulowy WW**L** GRUPA RABATOWA

indeks	wielkość	PN	rodzaj uchwyty	kolor uchwyty	Tmax	pakowanie		cena netto [zł]
<b>KX02-0150-000</b>	½"	30	motyl	czerwony	+130°C	15	150	<b>20,38</b>
<b>KX02-0200-000</b>	¾"	30	motyl	czerwony	+130°C	10	100	<b>29,98</b>
<b>KX02-0250-000</b>	1"	30	motyl	czerwony	+130°C	6	60	<b>47,80</b>

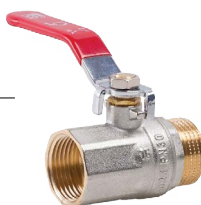
**KX03****KROS**  
kurek kulowy WZ**L** GRUPA RABATOWA

indeks	wielkość	PN	rodzaj uchwyty	kolor uchwyty	Tmax	pakowanie		cena netto [zł]
<b>KX03-0150-000</b>	½"	30	rączka	czerwony	+130°C	15	150	<b>21,18</b>
<b>KX03-0200-000</b>	¾"	30	rączka	czerwony	+130°C	10	100	<b>31,20</b>
<b>KX03-0250-000</b>	1"	30	rączka	czerwony	+130°C	6	60	<b>49,04</b>

**KX04****KROS**  
kurek kulowy WZ**L** GRUPA RABATOWA

indeks	wielkość	PN	rodzaj uchwyty	kolor uchwyty	Tmax	pakowanie		cena netto [zł]
<b>KX04-0150-000</b>	½"	30	motyl	czerwony	+130°C	15	150	<b>20,50</b>
<b>KX04-0200-000</b>	¾"	30	motyl	czerwony	+130°C	10	100	<b>31,53</b>
<b>KX04-0250-000</b>	1"	30	motyl	czerwony	+130°C	6	60	<b>52,03</b>

**KX06****KROS**  
kurek kulowy z filtrem skośnym**L** GRUPA RABATOWA

indeks	wielkość	PN	rodzaj uchwyty	kolor uchwyty	Tmax	pakowanie		cena netto [zł]
<b>KX06-0250-000</b>	1"	10	rączka	czerwony	+120°C	4	40	<b>76,29</b>

**1040WW**

Kurek kulowy WW

**A** GRUPA RABATOWA

indeks	wielkość	PN	rodzaj uchwyty	kolor uchwyty	Tmax	pakowanie		cena netto [zł]
<b>00-200-0150-010</b>	½"	16	rączka	czerwony	+120°C	16	160	<b>19,52</b>
<b>00-200-0200-010</b>	¾"	16	rączka	czerwony	+120°C	12	120	<b>27,05</b>
<b>00-200-0250-010</b>	1"	16	rączka	czerwony	+120°C	6	60	<b>44,07</b>
<b>00-200-0320-010</b>	1¼"	16	rączka	czerwony	+120°C	4	40	<b>67,43</b>
<b>00-200-0400-010</b>	1½"	16	rączka	czerwony	+120°C	4	32	<b>103,26</b>
<b>00-200-0500-010</b>	2"	16	rączka	czerwony	+120°C	2	20	<b>170,89</b>

**1041WW**

Kurek kulowy WW

**A** GRUPA RABATOWA

indeks	wielkość	PN	rodzaj uchwyty	kolor uchwyty	Tmax	pakowanie		cena netto [zł]
<b>00-220-0150-010</b>	½"	16	motyl	czerwony	+120°C	16	160	<b>20,06</b>
<b>00-220-0200-010</b>	¾"	16	motyl	czerwony	+120°C	12	120	<b>27,30</b>
<b>00-220-0250-010</b>	1"	16	motyl	czerwony	+120°C	6	60	<b>46,41</b>



**1040WZ**

Kurek kulowy WZ



**A** GRUPA RABATOWA

indeks	wielkość	PN	rodzaj uchwytu	kolor uchwytu	Tmax	pakowanie	cena netto [zł]
<b>00-202-0150-010</b>	½"	16	rączka	czerwony	+120°C	16 160	<b>19,83</b>
<b>00-202-0200-010</b>	¾"	16	rączka	czerwony	+120°C	12 120	<b>28,38</b>
<b>00-202-0250-010</b>	1"	16	rączka	czerwony	+120°C	6 60	<b>47,63</b>

**1041WZ**

Kurek kulowy WZ



**A** GRUPA RABATOWA

indeks	wielkość	PN	rodzaj uchwytu	kolor uchwytu	Tmax	pakowanie	cena netto [zł]
<b>00-222-0150-010</b>	½"	16	motyl	czerwony	+120°C	16 160	<b>20,72</b>
<b>00-222-0200-010</b>	¾"	16	motyl	czerwony	+120°C	12 120	<b>28,13</b>
<b>00-222-0250-010</b>	1"	16	motyl	czerwony	+120°C	6 60	<b>48,22</b>

**1410WW**

Kurek kulowy z dławikiem WW

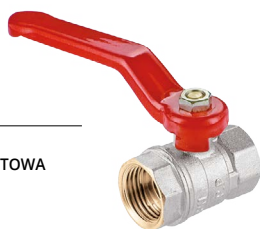

**A** GRUPA RABATOWA

indeks	wielkość	PN	rodzaj uchwytu	kolor uchwytu	Tmax	pakowanie	cena netto [zł]
<b>00-200-0650-000</b>	2½"	10	rączka	czerwony	+120°C	2 10	<b>299,30</b>
<b>00-200-0800-000</b>	3"	10	rączka	czerwony	+120°C	2 4	<b>445,16</b>
<b>00-200-1000-000</b>	4"	10	rączka	czerwony	+120°C	2 4	<b>728,84</b>

**1504**

Kurek kulowy do wlotowania



**E** GRUPA RABATOWA

Produkt dostępny do wyczerpania zapasów

indeks	wielkość	PN	rodzaj uchwytu	kolor uchwytu	Tmax	pakowanie	cena netto [zł]
<b>01-304-0150-000</b>	15	10	rączka	czerwony	+120°C	16 160	<b>21,74</b>
<b>01-304-0280-000</b>	28	10	rączka	czerwony	+120°C	6 60	<b>57,42</b>

**65RU**

Kurek kulowy z zaworem spustowym WW



**E** GRUPA RABATOWA

indeks	wielkość	PN	rodzaj uchwytu	kolor uchwytu	Tmax	pakowanie	cena netto [zł]
<b>01-303-0150-000</b>	½"	30	rączka	czerwony	+120°C	8 80	<b>35,24</b>
<b>01-303-0200-000</b>	¾"	30	rączka	czerwony	+120°C	6 60	<b>44,69</b>
<b>01-303-0250-000</b>	1"	30	rączka	czerwony	+120°C	4 40	<b>65,92</b>
<b>01-303-0320-000</b>	1¼"	25	rączka	czerwony	+120°C	2 32	<b>103,32</b>
<b>01-303-0400-000</b>	1½"	25	rączka	czerwony	+120°C	2 24	<b>149,01</b>
<b>01-303-0500-000</b>	2"	25	rączka	czerwony	+120°C	2 16	<b>218,56</b>

**PHA-019D**

**PERFEKT SYSTEM**  
Kurek kul. z dław. ze złączką do łączenia z rurą PEX lub PERT



**K** GRUPA RABATOWA

**PERFEKT<sup>2</sup>SYSTEM**

indeks	wielkość	PN	rodzaj uchwytu	kolor uchwytu	Tmax	pakowanie	cena netto [zł]
<b>01-019-0000-001</b>	½"	16	rączka	czerwony	+120°C	17 170	<b>20,38</b>
<b>01-019-1000-001</b>	½"	16	rączka	niebieski	+120°C	17 170	<b>20,38</b>

**PHA-019S**

**PERFEKT SYSTEM**  
Kurek kulowy spustowy z dławikiem ze złączką do węży



**K** GRUPA RABATOWA

**PERFEKT<sup>2</sup>SYSTEM**

indeks	wielkość	PN	rodzaj uchwytu	kolor uchwytu	Tmax	pakowanie	cena netto [zł]
<b>01-019-0000-002</b>	½"	16	rączka	czerwony	+120°C	25 250	<b>20,97</b>
<b>01-019-1000-002</b>	½"	16	rączka	niebieski	+120°C	25 250	<b>20,97</b>



## 1809

Kurek kulowy spustowy  
ze złączką do węża

indeks	wielkość	PN	rodzaj uchwyty	kolor uchwyty	Tmax	pakowanie		cena netto [zł]
<b>20-205-0150-000</b>	½"	25	rączka	czerwony	+150°C	15	150	<b>28,14</b>
<b>20-205-0200-000</b>	¾"	25	rączka	czerwony	+150°C	15	120	<b>39,34</b>

E GRUPA RABATOWA



## 3021WW

Kurek kulowy  
typ MINI WW

indeks	wielkość	PN	rodzaj uchwyty	kolor uchwyty	Tmax	pakowanie		cena netto [zł]
<b>01-301-0150-000</b>	½"	16	rączka	czerwony	+120°C	20	180	<b>19,76</b>

E GRUPA RABATOWA



## 3021WZ

Kurek kulowy  
typ MINI WZ

indeks	wielkość	PN	rodzaj uchwyty	kolor uchwyty	Tmax	pakowanie		cena netto [zł]
<b>01-302-0150-001</b>	½"	16	rączka	czerwony	+120°C	25	250	<b>19,08</b>

E GRUPA RABATOWA



## 428CH

Kurek kulowy  
podtynkowy

indeks	wielkość	PN	Tmax	pakowanie		cena netto [zł]
<b>01-305-0150-000</b>	½"	30	+120°C	5	50	<b>66,13</b>
<b>01-305-0200-000</b>	¾"	30	+120°C	4	40	<b>76,96</b>

E GRUPA RABATOWA



## PHA-060

PERFEKT SYSTEM  
Filtr skośny do wody

indeks	wielkość	PN	Tmax	pakowanie		cena netto [zł]
<b>03-060-0150-000</b>	½"	25	+150°C	18	180	<b>19,74</b>
<b>03-060-0200-000</b>	¾"	25	+150°C	12	120	<b>31,25</b>
<b>03-060-0250-000</b>	1"	25	+150°C	10	100	<b>42,97</b>
<b>03-060-0320-000</b>	1¼"	25	+150°C	4	40	<b>82,97</b>
<b>03-060-0400-000</b>	1½"	25	+150°C	3	30	<b>109,37</b>
<b>03-060-0500-000</b>	2"	25	+150°C	2	20	<b>178,51</b>
<b>03-060-0650-000</b>	2½"	20	+150°C	1	10	<b>284,27</b>
<b>03-060-0800-000</b>	3"	20	+150°C	1	10	<b>446,36</b>

K GRUPA RABATOWA



## PHA-060M

PERFEKT SYSTEM  
Filtr skośny do wody  
z wkładem magnetycznym

indeks	wielkość	PN	Tmax	pakowanie		cena netto [zł]
<b>03-060-0150-100</b>	½"	25	+150°C	18	180	<b>46,00</b>
<b>03-060-0200-100</b>	¾"	25	+150°C	12	120	<b>56,00</b>
<b>03-060-0250-100</b>	1"	25	+150°C	10	100	<b>65,00</b>
<b>03-060-0320-100</b>	1¼"	25	+150°C	4	10	<b>210,24</b>
<b>03-060-0400-100</b>	1½"	25	+150°C	3	10	<b>239,26</b>
<b>03-060-0500-100</b>	2"	25	+150°C	2	10	<b>368,83</b>

K GRUPA RABATOWA

dostępne w III kwartale 2024



**US-060**Uszczelka i siatka do filtra  
PHA-060**(K)** GRUPA RABATOWA**PERFEKT** SYSTEM

indeks	wielkość	pakowanie		cena netto [zł]
<b>03-200-0000-150</b>	½"	1	1	<b>1,80</b>
<b>03-200-0000-200</b>	¾"	1	1	<b>2,76</b>
<b>03-200-0000-250</b>	1"	1	1	<b>3,59</b>
<b>03-200-0000-320</b>	1¼"	1	1	<b>7,15</b>
<b>03-200-0000-400</b>	1½"	1	1	<b>9,49</b>
<b>03-200-0000-500</b>	2"	1	1	<b>13,77</b>
<b>03-200-0000-650</b>	2½"	1	1	<b>16,00</b>
<b>03-200-0000-800</b>	3"	1	1	<b>21,00</b>

**5503**Zawór zwrotny  
z mosiężnym grzybkiem**(B)** GRUPA RABATOWA

indeks	wielkość	PN	Tmax	pakowanie		cena netto [zł]
<b>04-100-0150-000</b>	½"	10	+120°C	16	192	<b>19,29</b>
<b>04-100-0200-000</b>	¾"	10	+120°C	10	150	<b>24,78</b>
<b>04-100-0250-000</b>	1"	10	+120°C	9	108	<b>32,52</b>
<b>04-100-0320-000</b>	1¼"	10	+120°C	6	48	<b>58,21</b>
<b>04-100-0400-000</b>	1½"	10	+120°C	2	40	<b>77,67</b>
<b>04-100-0500-000</b>	2"	10	+120°C	2	30	<b>116,55</b>
<b>04-100-0650-000</b>	2½"	8	+120°C	2	10	<b>194,30</b>

**5503/P**Zawór zwrotny  
z grzybkiem z tworzywa**(B)** GRUPA RABATOWA

indeks	wielkość	PN	Tmax	pakowanie		cena netto [zł]
<b>04-100-0150-100</b>	½"	10	+120°C	16	192	<b>18,20</b>
<b>04-100-0200-100</b>	¾"	10	+120°C	10	150	<b>23,86</b>
<b>04-100-0250-100</b>	1"	10	+120°C	9	108	<b>31,57</b>
<b>04-100-0320-100</b>	1¼"	10	+120°C	6	48	<b>57,05</b>
<b>04-100-0400-100</b>	1½"	10	+120°C	2	40	<b>76,17</b>
<b>04-100-0500-100</b>	2"	10	+120°C	2	30	<b>114,26</b>

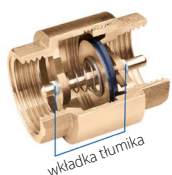
**PHA-020****PERFEKT SYSTEM**  
Zawór zwrotny  
z mosiężnym grzybkiem**(K)** GRUPA RABATOWA

wkładka tłumika

**PERFEKT** SYSTEM

indeks	wielkość	PN	Tmax	pakowanie		cena netto [zł]
<b>04-020-0150-000</b>	½"	16	+120°C	19	228	<b>21,36</b>
<b>04-020-0200-000</b>	¾"	16	+120°C	12	144	<b>29,54</b>
<b>04-020-0250-000</b>	1"	16	+120°C	9	108	<b>42,15</b>
<b>04-020-0320-000</b>	1¼"	10	+120°C	6	72	<b>61,53</b>
<b>04-020-0400-000</b>	1½"	10	+120°C	6	36	<b>94,60</b>
<b>04-020-0500-000</b>	2"	10	+120°C	1	30	<b>133,37</b>
<b>04-020-0650-000</b>	2½"	10	+120°C	1	16	<b>283,25</b>
<b>04-020-0800-000</b>	3"	10	+120°C	1	12	<b>387,81</b>
<b>04-020-1000-000</b>	4"	10	+120°C	1	4	<b>652,52</b>

**PHA-KS1****PERFEKT SYSTEM**  
Kosz ssawny do zaworu  
zwrotnego PHA-020**(K)** GRUPA RABATOWA**PERFEKT** SYSTEM

indeks	wielkość	pakowanie		cena netto [zł]
<b>04-901-0150-000</b>	½"	54	648	<b>5,00</b>
<b>04-901-0200-000</b>	¾"	28	336	<b>6,84</b>
<b>04-901-0250-000</b>	1"	30	180	<b>9,09</b>
<b>04-901-0320-000</b>	1¼"	20	120	<b>11,21</b>
<b>04-901-0400-000</b>	1½"	6	72	<b>12,93</b>
<b>04-901-0500-000</b>	2"	4	48	<b>16,79</b>
<b>04-901-0650-000</b>	2½"	1	28	<b>29,56</b>
<b>04-901-0800-000</b>	3"	1	22	<b>34,09</b>
<b>04-901-1000-000</b>	4"	1	12	<b>49,64</b>

## PHA-021

## PERFEKT SYSTEM

Zawór zwrotny klapkowy



GRUPA RABATOWA

PERFEKT<sup>SYSTEM</sup>

indeks	wielkość	PN	Tmax	pakowanie		cena netto [zł]
<b>04-021-0150-000</b>	½"	16	+120°C	12	144	<b>27,46</b>
<b>04-021-0200-000</b>	¾"	16	+120°C	10	80	<b>37,32</b>
<b>04-021-0250-000</b>	1"	16	+120°C	8	96	<b>53,52</b>
<b>04-021-0320-000</b>	1¼"	10	+120°C	6	36	<b>94,12</b>
<b>04-021-0400-000</b>	1½"	10	+120°C	4	24	<b>118,92</b>
<b>04-021-0500-000</b>	2"	10	+120°C	2	12	<b>164,35</b>
<b>04-021-0650-000</b>	2½"	10	+120°C	1	12	<b>280,49</b>
<b>04-021-0800-000</b>	3"	10	+120°C	1	8	<b>411,37</b>

## PHA-013

## PERFEKT SYSTEM

Zawór antyskażeniowy typ "EA"



GRUPA RABATOWA

PERFEKT<sup>SYSTEM</sup>

indeks	wielkość	PN	Tmax	pakowanie		cena netto [zł]
<b>01-013-0150-000</b>	½"	10	+65°C	18	180	<b>24,39</b>
<b>01-013-0200-000</b>	¾"	10	+65°C	16	128	<b>32,40</b>
<b>01-013-0250-000</b>	1"	10	+65°C	10	180	<b>49,09</b>

## PHA-022

## PERFEKT SYSTEM

Zasuwa mosiężna



GRUPA RABATOWA

PERFEKT<sup>SYSTEM</sup>

indeks	wielkość	PN	Tmax	pakowanie		cena netto [zł]
<b>01-022-0150-000</b>	½"	10	+100°C	20	80	<b>30,72</b>
<b>01-022-0200-000</b>	¾"	10	+100°C	15	60	<b>41,22</b>
<b>01-022-0250-000</b>	1"	10	+100°C	8	48	<b>60,96</b>
<b>01-022-0320-000</b>	1¼"	10	+100°C	2	24	<b>90,55</b>
<b>01-022-0400-000</b>	1½"	10	+100°C	2	24	<b>119,37</b>
<b>01-022-0500-000</b>	2"	10	+100°C	3	12	<b>190,34</b>
<b>01-022-0650-000</b>	2½"	10	+100°C	2	12	<b>345,16</b>
<b>01-022-0800-000</b>	3"	10	+100°C	2	8	<b>474,11</b>

## 1620

Zawór antyskażeniowy skośny

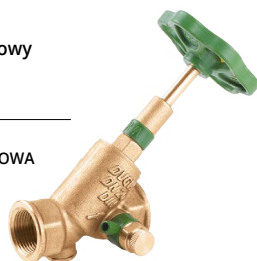

GRUPA RABATOWA

indeks	wielkość	PN	Tmax	pakowanie		cena netto [zł]
<b>01-402-0150-000</b>	½"	10	+90°C	1	20	<b>89,13</b>
<b>01-402-0200-000</b>	¾"	10	+90°C	1	10	<b>109,60</b>
<b>01-402-0250-000</b>	1"	10	+90°C	1	5	<b>139,85</b>
<b>01-402-0320-000</b>	1¼"	10	+90°C	1	4	<b>246,13</b>
<b>01-402-0400-000</b>	1½"	10	+90°C	1	1	<b>289,01</b>
<b>01-402-0500-000</b>	2"	10	+90°C	1	1	<b>447,47</b>

## 1505

Zawór przepływowy skośny

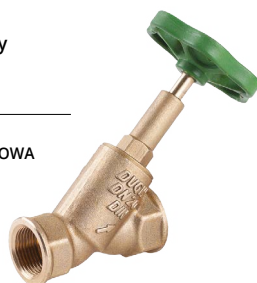

GRUPA RABATOWA

indeks	wielkość	PN	Tmax	pakowanie		cena netto [zł]
<b>01-401-0150-000</b>	½"	10	+90°C	1	20	<b>35,82</b>
<b>01-401-0200-000</b>	¾"	10	+90°C	1	10	<b>56,75</b>
<b>01-401-0250-000</b>	1"	10	+90°C	1	5	<b>74,47</b>
<b>01-401-0320-000</b>	1¼"	10	+90°C	1	4	<b>151,17</b>
<b>01-401-0400-000</b>	1½"	10	+90°C	1	1	<b>174,73</b>
<b>01-401-0500-000</b>	2"	10	+90°C	1	1	<b>311,00</b>

## 1105

Zawór przepływowy grzybkowy prosty



GRUPA RABATOWA

indeks	wielkość	PN	Tmax	pakowanie		cena netto [zł]
<b>01-400-0150-000</b>	½"	10	+90°C	1	20	<b>42,54</b>
<b>01-400-0200-000</b>	¾"	10	+90°C	1	15	<b>58,01</b>
<b>01-400-0250-000</b>	1"	10	+90°C	1	10	<b>91,63</b>
<b>01-400-0320-000</b>	1¼"	10	+90°C	1	5	<b>155,55</b>
<b>01-400-0400-000</b>	1½"	10	+90°C	1	3	<b>222,69</b>
<b>01-400-0500-000</b>	2"	10	+90°C	1	1	<b>323,94</b>

**ZKR-111**

Zawór zwrotny kulowy różnicowy

**D** GRUPA RABATOWA

indeks	wielkość	PN	Tmax	pakowanie		cena netto [zł]
<b>04-101-0250-000</b>	1"	6	+120°C	1	24	<b>70,34</b>
<b>04-101-0320-000</b>	1¼"	6	+120°C	1	18	<b>78,08</b>
<b>04-101-0400-000</b>	1½"	6	+120°C	1	16	<b>90,36</b>
<b>04-101-0500-000</b>	2"	6	+120°C	1	12	<b>111,54</b>

**G02**

Głowica do zaworów żeliwnych z uszczelką płaską fibrową

**B** GRUPA RABATOWA

indeks	wielkość	PN	Tmax	pakowanie		cena netto [zł]
<b>01-500-0150-000</b>	½"	10	+90°C	20	120	<b>16,07</b>
<b>01-500-0200-000</b>	¾"	10	+90°C	20	120	<b>19,80</b>
<b>01-500-0250-000</b>	1"	10	+90°C	15	60	<b>27,20</b>
<b>01-500-0320-000</b>	1¼"	10	+90°C	10	80	<b>58,47</b>
<b>01-500-0400-000</b>	1½"	10	+90°C	5	60	<b>71,12</b>
<b>01-500-0500-000</b>	2"	10	+90°C	5	30	<b>111,51</b>

**3098**

Zawór żeliwny ocynkowany przelotowy prosty

**B** GRUPA RABATOWA

indeks	wielkość	PN	Tmax	pakowanie		cena netto [zł]
<b>01-400-0150-100</b>	½"	10	+120°C	8	64	<b>24,00</b>
<b>01-400-0200-100</b>	¾"	10	+120°C	8	48	<b>31,00</b>
<b>01-400-0250-100</b>	1"	10	+120°C	4	24	<b>46,50</b>
<b>01-400-0320-100</b>	1¼"	10	+120°C	3	18	<b>92,30</b>
<b>01-400-0400-100</b>	1½"	10	+120°C	4	16	<b>134,34</b>
<b>01-400-0500-100</b>	2"	10	+120°C	2	8	<b>227,33</b>

**3099**

Zawór żeliwny ocynkowany czerpalny z szybkozłączką do węża

**B** GRUPA RABATOWA

indeks	wielkość	PN	Tmax	pakowanie		cena netto [zł]
<b>01-009-0150-005</b>	½"	10	+120°C	8	32	<b>33,43</b>
<b>01-009-0200-005</b>	¾"	10	+120°C	7	28	<b>48,47</b>

**PHA-070**

Kurek kulowy czerpalny mrozoodporny

**K** GRUPA RABATOWA**PERFEKT<sup>SYSTEM</sup>**

indeks	wielkość	PN	Tmax	pakowanie		cena netto [zł]
<b>01-070-0150-000</b>	½"	15	+120°C	12	120	<b>29,36</b>
<b>01-070-0200-000</b>	¾"	20	+120°C	10	100	<b>40,17</b>

**3102**

Kurek kulowy czerpalny ze złączką do węża

**B** GRUPA RABATOWA

indeks	wielkość	PN	Tmax	pakowanie		cena netto [zł]
<b>01-009-0150-002</b>	½"	10	+80°C	10	100	<b>23,92</b>
<b>01-009-0200-002</b>	¾"	10	+80°C	10	100	<b>33,22</b>
<b>01-009-0250-002</b>	1"	10	+80°C	5	40	<b>53,74</b>

**PHA-009****PERFEKT SYSTEM**

Kurek kulowy czerpalny z dławikiem ze złączką do węża

**(K)** GRUPA RABATOWA**PERFEKT SYSTEM**

indeks	wielkość	PN	Tmax	pakowanie		cena netto [zł]
<b>01-009-0150-000</b>	½"	16	+120°C	10	100	<b>26,33</b>
<b>01-009-0200-000</b>	¾"	16	+120°C	10	100	<b>37,14</b>
<b>01-009-0250-000</b>	1"	16	+120°C	5	40	<b>61,56</b>

**PHA-009 DUO****PERFEKT SYSTEM**

Kurek kulowy czerpalny podwójny

**(K)** GRUPA RABATOWA**PERFEKT SYSTEM**

indeks	wielkość	PN	Tmax	pakowanie		cena netto [zł]
<b>01-009-0150-006</b>	½"	16	+120°C			



Produkt dostępny w III kwartale 2024

**PHA-009S****PERFEKT SYSTEM**

Kurek kulowy czerpalny z dławikiem z szybkozłączką do węża

**(K)** GRUPA RABATOWA**PERFEKT SYSTEM**

indeks	wielkość	PN	Tmax	pakowanie		cena netto [zł]
<b>01-009-0150-001</b>	½"	16	+120°C	10	100	<b>26,33</b>
<b>01-009-0200-001</b>	¾"	16	+120°C	10	100	<b>37,14</b>

**PHA-015****PERFEKT SYSTEM**

Zawór czerpalny grzybkowy mosiężny chromowany

**(K)** GRUPA RABATOWA**PERFEKT SYSTEM**

indeks	wielkość	PN	Tmax	pakowanie		cena netto [zł]
<b>01-015-0150-000</b>	½"	10	+90°C	1	48	<b>51,58</b>

**Adapter**

Adapter (redukcja) do zbiornika IBC

**(B)** GRUPA RABATOWA

indeks	wielkość	Tmax	pakowanie		cena netto [zł]
<b>01-009-0150-010</b>	½"	+65°C	1	300	<b>24,10</b>
<b>01-009-0200-010</b>	¾"	+65°C	1	300	<b>24,10</b>
<b>01-009-0250-010</b>	1"	+65°C	1	300	<b>24,10</b>

**Adapter z króćcem**

Adapter(redukcja) do zbiornika IBC z króćcem na wąż

**(B)** GRUPA RABATOWA

indeks	średnica trzpienia	Tmax	pakowanie		cena netto [zł]
<b>01-009-0140-010</b>	Ø14	+65°C	1	170	<b>31,59</b>



**09 - Kurek z adapterem**

Kurek kulowy czerpalny z adapterem (redukcją) do zbiornika IBC

**(K)** GRUPA RABATOWA

indeks	wielkość	Tmax	pakowanie	cena netto [zł]
<b>01-009-0150-011</b>	1/2"	+65°C	1	<b>49,09</b>
<b>01-009-0200-011</b>	3/4"	+65°C	1	<b>53,41</b>

**Końcówka do kurka PHA-009S**

Końcówka do kurka

**(B)** GRUPA RABATOWA

indeks	wielkość	pakowanie	cena netto [zł]
<b>01-900-0150-001</b>	1/2"	10 1000	<b>3,08</b>

**3110**

Końcówka do węża

**(B)** GRUPA RABATOWA

indeks	wielkość	pakowanie	cena netto [zł]
<b>01-900-0150-000</b>	1/2"	10 1200	<b>2,85</b>
<b>01-900-0200-000</b>	3/4"	10 900	<b>4,60</b>
<b>01-900-0250-000</b>	1"	15 450	<b>6,82</b>

**PHA-304**

Nypel mosiężny wzmocniony

**(K)** GRUPA RABATOWA**PERFEKT<sup>2</sup>SYSTEM**

indeks	wielkość	PN	Tmax	pakowanie	cena netto [zł]
<b>07-004-0100-000</b>	3/8"	16	+180°C	20 500	<b>3,40</b>
<b>07-004-0150-000</b>	1/2"	16	+180°C	20 500	<b>5,31</b>
<b>07-004-0200-000</b>	3/4"	16	+180°C	20 400	<b>8,54</b>
<b>07-004-0250-000</b>	1"	16	+180°C	20 100	<b>15,42</b>
<b>07-004-0320-000</b>	1 1/4"	16	+180°C	10 50	<b>25,59</b>
<b>07-004-0400-000</b>	1 1/2"	16	+180°C	10 50	<b>34,31</b>
<b>07-004-0500-000</b>	2"	16	+180°C	5 50	<b>52,22</b>

**PHA-304/S**

Nypel mosiężny wzmocniony pod uszczelkę płaską

**(K)** GRUPA RABATOWA**PERFEKT<sup>2</sup>SYSTEM**

indeks	wielkość	PN	Tmax	pakowanie	cena netto [zł]
<b>07-004-0150-100</b>	1/2"	16	+180°C	20 400	<b>5,97</b>
<b>07-004-0200-100</b>	3/4"	16	+180°C	20 260	<b>9,30</b>
<b>07-004-0250-100</b>	1"	16	+180°C	10 130	<b>17,00</b>

**PHA-305**

Mufa mosiężna wzmocniona

**(K)** GRUPA RABATOWA**PERFEKT<sup>2</sup>SYSTEM**

indeks	wielkość	PN	Tmax	pakowanie	cena netto [zł]
<b>07-005-0100-000</b>	3/8"	16	+180°C	10 200	<b>3,71</b>
<b>07-005-0150-000</b>	1/2"	16	+180°C	20 400	<b>7,88</b>
<b>07-005-0200-000</b>	3/4"	16	+180°C	20 300	<b>10,94</b>
<b>07-005-0250-000</b>	1"	16	+180°C	10 100	<b>20,54</b>
<b>07-005-0320-000</b>	1 1/4"	16	+180°C	10 50	<b>34,51</b>
<b>07-005-0400-000</b>	1 1/2"	16	+180°C	10 50	<b>37,96</b>
<b>07-005-0500-000</b>	2"	16	+180°C	10 30	<b>49,23</b>



**PHA-306**Redukcja mosiężna  
wzmocniona**(K)** GRUPA RABATOWA**PERFEKT<sup>2</sup>**<sub>SYSTEM</sub>

indeks	wielkość	PN	Tmax	pakowanie	cena netto [zł]
<b>07-006-1510-000</b>	½" x ¾"	16	+180°C	20 500	<b>3,27</b>
<b>07-006-2015-000</b>	¾" x ½"	16	+180°C	20 800	<b>5,27</b>
<b>07-006-2515-000</b>	1" x ½"	16	+180°C	20 400	<b>11,77</b>
<b>07-006-2520-000</b>	1" x ¾"	16	+180°C	20 400	<b>9,40</b>
<b>07-006-3220-000</b>	1¼" x ¾"	16	+180°C	10 200	<b>21,98</b>
<b>07-006-3225-000</b>	1¼" x 1"	16	+180°C	10 200	<b>17,01</b>
<b>07-006-4025-000</b>	1½" x 1"	16	+180°C	10 100	<b>32,13</b>
<b>07-006-4032-000</b>	1½" x 1¼"	16	+180°C	10 100	<b>19,33</b>
<b>07-006-5025-000</b>	2" x 1"	16	+180°C	10 50	<b>57,35</b>
<b>07-006-5032-000</b>	2" x 1¼"	16	+180°C	10 50	<b>51,84</b>
<b>07-006-5040-000</b>	2" x 1½"	16	+180°C	10 50	<b>48,83</b>

**PHA-307**Nypel redukcyjny mosiężny  
wzmocniony**(K)** GRUPA RABATOWA**PERFEKT<sup>2</sup>**<sub>SYSTEM</sub>

indeks	wielkość	PN	Tmax	pakowanie	cena netto [zł]
<b>07-007-1510-000</b>	½" x ¾"	16	+180°C	20 500	<b>5,15</b>
<b>07-007-2015-000</b>	¾" x ½"	16	+180°C	20 400	<b>8,37</b>
<b>07-007-2515-000</b>	1" x ½"	16	+180°C	20 200	<b>14,53</b>
<b>07-007-2520-000</b>	1" x ¾"	16	+180°C	20 200	<b>15,16</b>
<b>07-007-3225-000</b>	1¼" x 1"	16	+180°C	10 150	<b>25,85</b>
<b>07-007-4025-000</b>	1½" x 1"	16	+180°C	10 150	<b>35,26</b>
<b>07-007-5025-000</b>	2" x 1"	16	+180°C	10 100	<b>56,45</b>
<b>07-007-5032-000</b>	2" x 1¼"	16	+180°C	10 100	<b>57,56</b>
<b>07-007-5040-000</b>	2" x 1½"	16	+180°C	10 100	<b>55,55</b>

**PHA-308**Redukcja mufowo-nypłowa  
mosiężna wzmocniona**(K)** GRUPA RABATOWA**PERFEKT<sup>2</sup>**<sub>SYSTEM</sub>

indeks	wielkość	PN	Tmax	pakowanie	cena netto [zł]
<b>07-008-1510-000</b>	½" x ¾"	16	+180°C	20 200	<b>5,74</b>
<b>07-008-2015-000</b>	¾" x ½"	16	+180°C	20 400	<b>8,69</b>
<b>07-008-2520-000</b>	1" x ¾"	16	+180°C	10 200	<b>14,64</b>

**PHA-309**Mufa redukcyjna mosiężna  
wzmocniona**(K)** GRUPA RABATOWA**PERFEKT<sup>2</sup>**<sub>SYSTEM</sub>

indeks	wielkość	PN	Tmax	pakowanie	cena netto [zł]
<b>07-009-1510-000</b>	½" x ¾"	16	+180°C	20 200	<b>5,19</b>
<b>07-009-2015-000</b>	¾" x ½"	16	+180°C	20 400	<b>8,62</b>
<b>07-009-2520-000</b>	1" x ¾"	16	+180°C	10 200	<b>16,72</b>

**PHA-310**Kolano mosiężne  
wzmocnione**(K)** GRUPA RABATOWA**PERFEKT<sup>2</sup>**<sub>SYSTEM</sub>

indeks	wielkość	PN	Tmax	pakowanie	cena netto [zł]
<b>07-010-0100-000</b>	¾"	16	+180°C	20 400	<b>6,49</b>
<b>07-010-0150-000</b>	½"	16	+180°C	20 200	<b>9,60</b>
<b>07-010-0200-000</b>	¾"	16	+180°C	20 200	<b>14,85</b>
<b>07-010-0250-000</b>	1"	16	+180°C	20 100	<b>30,81</b>
<b>07-010-0320-000</b>	1¼"	16	+180°C	10 50	<b>46,32</b>
<b>07-010-0400-000</b>	1½"	16	+180°C	10 50	<b>69,69</b>
<b>07-010-0500-000</b>	2"	16	+180°C	10 50	<b>98,60</b>

## PHA-311

Kolano mosiężne  
wzmocnione WZ**(K)** GRUPA RABATOWAPERFEKT<sup>SYSTEM</sup>

indeks	wielkość	PN	Tmax	pakowanie		cena netto [zł]
<b>07-011-0100-000</b>	3/8"	16	+180°C	10	200	<b>6,41</b>
<b>07-011-0150-000</b>	1/2"	16	+180°C	20	400	<b>9,43</b>
<b>07-011-0200-000</b>	3/4"	16	+180°C	20	300	<b>15,74</b>
<b>07-011-0250-000</b>	1"	16	+180°C	20	200	<b>29,30</b>
<b>07-011-0320-000</b>	1 1/4"	16	+180°C	10	50	<b>48,28</b>
<b>07-011-0400-000</b>	1 1/2"	16	+180°C	10	50	<b>68,57</b>
<b>07-011-0500-000</b>	2"	16	+180°C	10	50	<b>100,14</b>

## PHA-312

Trójnik mosiężny  
wzmocniony**(K)** GRUPA RABATOWAPERFEKT<sup>SYSTEM</sup>

indeks	wielkość	PN	Tmax	pakowanie		cena netto [zł]
<b>07-012-0100-000</b>	3/8"	16	+180°C	10	100	<b>7,94</b>
<b>07-012-0150-000</b>	1/2"	16	+180°C	20	200	<b>11,67</b>
<b>07-012-0200-000</b>	3/4"	16	+180°C	20	200	<b>19,61</b>
<b>07-012-0250-000</b>	1"	16	+180°C	20	100	<b>39,87</b>
<b>07-012-0320-000</b>	1 1/4"	16	+180°C	10	50	<b>56,57</b>
<b>07-012-0400-000</b>	1 1/2"	16	+180°C	10	50	<b>85,88</b>
<b>07-012-0500-000</b>	2"	16	+180°C	10	50	<b>122,39</b>

## PHA-313

Trójnik mosiężny  
wzmocniony WZ**(K)** GRUPA RABATOWAPERFEKT<sup>SYSTEM</sup>

indeks	wielkość	PN	Tmax	pakowanie		cena netto [zł]
<b>07-013-0100-000</b>	3/8"	16	+180°C	10	100	<b>6,58</b>
<b>07-013-0150-000</b>	1/2"	16	+180°C	10	100	<b>11,37</b>
<b>07-013-0200-000</b>	3/4"	16	+180°C	10	100	<b>18,54</b>
<b>07-013-0250-000</b>	1"	16	+180°C	10	100	<b>38,13</b>

## PHA-314

Trójnik redukcyjny  
mosiężny wzmocniony**(K)** GRUPA RABATOWAPERFEKT<sup>SYSTEM</sup>

indeks	wielkość	PN	Tmax	pakowanie		cena netto [zł]
<b>07-014-2015-000</b>	3/4" x 1/2"	16	+180°C	10	100	<b>19,33</b>
<b>07-014-2515-000</b>	1" x 1/2"	16	+180°C	10	100	<b>33,54</b>
<b>07-014-2520-000</b>	1" x 3/4"	16	+180°C	10	100	<b>36,52</b>

## PHA-315

Przedłużka mosiężna  
wzmocniona WZ**(K)** GRUPA RABATOWAPERFEKT<sup>SYSTEM</sup>

indeks	wielkość	PN	Tmax	pakowanie		cena netto [zł]
<b>07-015-1015-000</b>	1/2" x 10	16	+180°C	20	540	<b>6,83</b>
<b>07-015-1515-000</b>	1/2" x 15	16	+180°C	20	540	<b>8,21</b>
<b>07-015-2015-000</b>	1/2" x 20	16	+180°C	20	320	<b>10,09</b>
<b>07-015-2515-000</b>	1/2" x 25	16	+180°C	20	320	<b>11,86</b>
<b>07-015-3015-000</b>	1/2" x 30	16	+180°C	20	320	<b>13,52</b>
<b>07-015-4015-000</b>	1/2" x 40	16	+180°C	20	320	<b>17,62</b>
<b>07-015-5015-000</b>	1/2" x 50	16	+180°C	20	240	<b>21,78</b>

## PHA-316

korek wzmocniony



(K) GRUPA RABATOWA

PERFEKT<sup>SYSTEM</sup>

indeks	wielkość	PN	Tmax	pakowanie		cena netto [zł]
<b>07-016-0320-000</b>	1¼"	16	+120°C	10	180	<b>17,70</b>
<b>07-016-0400-000</b>	1½"	16	+120°C	5	180	<b>20,95</b>

## PHA-318

Trójnik wzmocniony pod odpowietrznik



(K) GRUPA RABATOWA

PERFEKT<sup>SYSTEM</sup>

indeks	wielkość	PN	Tmax	pakowanie		cena netto [zł]
<b>07-018-2515-000</b>	1 x 1 x ½"	16	+120°C	5	60	<b>33,10</b>

## PHA-300

Śrubunek prosty o-ring mosiężny wzmocniony



(K) GRUPA RABATOWA

PERFEKT<sup>SYSTEM</sup>

indeks	wielkość	PN	Tmax	pakowanie		cena netto [zł]
<b>07-000-0150-000</b>	½" L-55mm	16	+120°C	20	200	<b>19,16</b>
<b>07-000-0200-000</b>	¾" L-60mm	16	+120°C	12	120	<b>30,45</b>
<b>07-000-0250-000</b>	1" L-65mm	16	+120°C	8	80	<b>55,29</b>

## PHA-301

Śrubunek prosty stożek mosiężny wzmocniony



(K) GRUPA RABATOWA

PERFEKT<sup>SYSTEM</sup>

indeks	wielkość	PN	Tmax	pakowanie		cena netto [zł]
<b>07-001-0150-000</b>	½" L-55mm	16	+120°C	20	200	<b>19,51</b>
<b>07-001-0200-000</b>	¾" L-60mm	16	+120°C	12	120	<b>30,45</b>
<b>07-001-0250-000</b>	1" L-65mm	16	+120°C	8	80	<b>55,29</b>

## 502G

Przedłużka mosiężna WZ



(D) GRUPA RABATOWA

PERFEKT<sup>SYSTEM</sup>

indeks	wielkość	PN	Tmax	pakowanie		cena netto [zł]
<b>07-220-1510-000</b>	½" x 10	16	+180°C	20	540	<b>4,59</b>
<b>07-220-1515-000</b>	½" x 15	16	+180°C	20	540	<b>5,51</b>
<b>07-220-1520-000</b>	½" x 20	16	+180°C	20	320	<b>6,82</b>
<b>07-220-1525-000</b>	½" x 25	16	+180°C	20	320	<b>8,01</b>
<b>07-220-1530-000</b>	½" x 30	16	+180°C	20	320	<b>9,31</b>
<b>07-220-1540-000</b>	½" x 40	16	+180°C	20	320	<b>10,72</b>
<b>07-220-1550-000</b>	½" x 50	16	+180°C	20	240	<b>14,06</b>
<b>07-220-1560-000</b>	½" x 60	16	+180°C	20	160	<b>17,26</b>
<b>07-220-1580-000</b>	½" x 80	16	+180°C	20	160	<b>21,65</b>
<b>07-220-1599-000</b>	½" x 100	16	+180°C	20	120	<b>26,37</b>
<b>07-220-2010-000</b>	¾" x 10	16	+180°C	10	550	<b>6,43</b>
<b>07-220-2015-000</b>	¾" x 15	16	+180°C	20	320	<b>7,95</b>
<b>07-220-2020-000</b>	¾" x 20	16	+180°C	20	320	<b>9,30</b>
<b>07-220-2030-000</b>	¾" x 30	16	+180°C	10	260	<b>12,77</b>
<b>07-220-2040-000</b>	¾" x 40	16	+180°C	20	180	<b>15,67</b>
<b>07-220-2050-000</b>	¾" x 50	16	+180°C	20	180	<b>18,10</b>

## 5101

Korek mosiężny GZ



**D** GRUPA RABATOWA

indeks	wielkość	PN	Tmax	pakowanie	cena netto [zł]
<b>07-201-0100-000</b>	3/8"	16	+180°C	50 1000	<b>3,84</b>
<b>07-201-0150-000</b>	1/2"	16	+180°C	50 1000	<b>3,58</b>
<b>07-201-0200-000</b>	3/4"	16	+180°C	50 500	<b>5,85</b>
<b>07-201-0250-000</b>	1"	16	+180°C	5 250	<b>10,54</b>

## 5102

Zaślepka mosiężna GW



**D** GRUPA RABATOWA

indeks	wielkość	PN	Tmax	pakowanie	cena netto [zł]
<b>07-202-0100-000</b>	3/8"	16	+180°C	50 800	<b>3,84</b>
<b>07-202-0150-000</b>	1/2"	16	+180°C	50 800	<b>3,58</b>
<b>07-202-0200-000</b>	3/4"	16	+180°C	130 520	<b>5,85</b>
<b>07-202-0250-000</b>	1"	16	+180°C	50 400	<b>12,78</b>
<b>07-202-0320-000</b>	1 1/4"	16	+180°C	1 1	<b>17,01</b>

## 5105

Nypel mosiężny



**D** GRUPA RABATOWA

indeks	wielkość	PN	Tmax	pakowanie	cena netto [zł]
<b>07-205-0100-000</b>	3/8"	16	+180°C	100 1200	<b>2,79</b>
<b>07-205-0150-000</b>	1/2"	16	+180°C	100 600	<b>4,23</b>
<b>07-205-0200-000</b>	3/4"	16	+180°C	50 400	<b>7,51</b>
<b>07-205-0250-000</b>	1"	16	+180°C	20 160	<b>13,79</b>
<b>07-205-0320-000</b>	1 1/4"	16	+180°C	10 120	<b>18,34</b>

## 5108

Mufa mosiężna



**D** GRUPA RABATOWA

indeks	wielkość	PN	Tmax	pakowanie	cena netto [zł]
<b>07-208-0150-000</b>	1/2"	16	+180°C	100 600	<b>6,32</b>
<b>07-208-0200-000</b>	3/4"	16	+180°C	50 400	<b>8,79</b>
<b>07-208-0250-000</b>	1"	16	+180°C	20 240	<b>15,18</b>
<b>07-208-0320-000</b>	1 1/4"	16	+180°C	10 120	<b>24,56</b>

## 5109

Nypel redukcyjny mosiężny



**D** GRUPA RABATOWA

indeks	wielkość	PN	Tmax	pakowanie	cena netto [zł]
<b>07-209-1510-000</b>	3/8" x 1/2"	16	+180°C	100 800	<b>4,03</b>
<b>07-209-1520-000</b>	1/2" x 3/4"	16	+180°C	50 400	<b>6,27</b>
<b>07-209-2025-000</b>	3/4" x 1"	16	+180°C	50 300	<b>11,36</b>

## 5110

Redukcja mosiężna



**D** GRUPA RABATOWA

indeks	wielkość	PN	Tmax	pakowanie	cena netto [zł]
<b>07-210-1008-000</b>	3/8" x 1/4"	16	+180°C	100 1200	<b>3,36</b>
<b>07-210-1508-000</b>	1/2" x 1/4"	16	+180°C	50 500	<b>4,42</b>
<b>07-210-1510-000</b>	1/2" x 3/8"	16	+180°C	100 1200	<b>2,53</b>
<b>07-210-1525-000</b>	1/2" x 1"	16	+180°C	50 400	<b>9,82</b>
<b>07-210-2015-000</b>	3/4" x 1/2"	16	+180°C	50 600	<b>4,46</b>
<b>07-210-2025-000</b>	3/4" x 1"	16	+180°C	50 400	<b>7,09</b>
<b>07-210-2532-000</b>	1" x 1 1/4"	16	+180°C	20 160	<b>16,26</b>

## 5111

Redukcja mufowo-nyplowa mosiężna



**D** GRUPA RABATOWA

indeks	wielkość	PN	Tmax	pakowanie	cena netto [zł]
<b>07-211-1510-000</b>	3/8" x 1/2"	16	+180°C	50 800	<b>4,49</b>
<b>07-211-1525-000</b>	1/2" x 1"	16	+180°C	50 200	<b>11,17</b>
<b>07-211-2015-000</b>	1/2" x 3/4"	16	+180°C	50 400	<b>6,46</b>
<b>07-211-2025-000</b>	3/4" x 1"	16	+180°C	50 200	<b>10,91</b>
<b>07-211-3225-000</b>	1" x 1 1/4"	16	+180°C	50 150	<b>19,91</b>

## 5112

Mufa redukcyjna  
mosiężna

indeks	wielkość	PN	Tmax	pakowanie		cena netto [zł]
<b>07-212-1510-000</b>	3/8" x 1/2"	16	+180°C	50	500	<b>4,77</b>
<b>07-212-2015-000</b>	1/2" x 3/4"	16	+180°C	50	400	<b>6,82</b>
<b>07-212-2515-000</b>	1/2" x 1"	16	+180°C	50	200	<b>10,96</b>
<b>07-212-2520-000</b>	3/4" x 1"	16	+180°C	50	200	<b>12,08</b>

D GRUPA RABATOWA



## 5113

Kolano mosiężne



indeks	wielkość	PN	Tmax	pakowanie		cena netto [zł]
<b>07-213-0100-000</b>	3/8"	16	+180°C	60	600	<b>5,29</b>
<b>07-213-0150-000</b>	1/2"	16	+180°C	50	500	<b>8,91</b>
<b>07-213-0200-000</b>	3/4"	16	+180°C	50	200	<b>13,79</b>
<b>07-213-0250-000</b>	1"	16	+180°C	20	120	<b>24,94</b>

D GRUPA RABATOWA



## 5114

Kolano mosiężne WZ



indeks	wielkość	PN	Tmax	pakowanie		cena netto [zł]
<b>07-214-0100-000</b>	3/8"	16	+180°C	60	600	<b>5,29</b>
<b>07-214-0150-000</b>	1/2"	16	+180°C	10	220	<b>8,98</b>
<b>07-214-0200-000</b>	3/4"	16	+180°C	50	200	<b>14,75</b>
<b>07-214-0250-000</b>	1"	16	+180°C	20	120	<b>26,93</b>

D GRUPA RABATOWA



## 5115

Kolano mosiężne  
redukcyjne WZ

indeks	wielkość	PN	Tmax	pakowanie		cena netto [zł]
<b>07-215-2015-000</b>	3/4" x 1/2"	16	+180°C	10	150	<b>12,42</b>
<b>07-215-2520-000</b>	1" x 3/4"	16	+180°C	10	100	<b>20,16</b>

D GRUPA RABATOWA



## 5116

Trójnik mosiężny



indeks	wielkość	PN	Tmax	pakowanie		cena netto [zł]
<b>07-216-0150-000</b>	1/2"	16	+180°C	10	180	<b>11,30</b>
<b>07-216-0200-000</b>	3/4"	16	+180°C	10	90	<b>17,89</b>
<b>07-216-0250-000</b>	1"	16	+180°C	5	50	<b>33,05</b>

D GRUPA RABATOWA



<b>07-216-1510-000</b>	1/2" x M10	16	+180°C	50	300	<b>19,83</b>
------------------------	------------	----	--------	----	-----	--------------



## 5118

Kolano mosiężne  
z mocowaniem WW

indeks	wielkość	PN	Tmax	pakowanie		cena netto [zł]
<b>07-218-0150-000</b>	1/2"	16	+180°C	10	150	<b>12,27</b>

D GRUPA RABATOWA



## 5119

Listwa montażowa  
pod baterię

indeks	wielkość	PN	Tmax	pakowanie		cena netto [zł]
<b>07-221-0100-000</b>	15 x 1/2 x 100	16	+110°C	1	60	<b>23,12</b>
<b>07-221-0150-000</b>	15 x 1/2 x 150	16	+110°C	1	20	<b>23,51</b>

D GRUPA RABATOWA



## 1046

Śrubunek prosty o-ring mosiężny



B GRUPA RABATOWA

indeks	wielkość	PN	Tmax	pakowanie		cena netto [zł]
<b>07-146-0100-000</b>	3/8"	16	+120°C	20	200	<b>10,40</b>
<b>07-146-0150-000</b>	1/2"	16	+120°C	18	270	<b>13,32</b>
<b>07-146-0200-000</b>	3/4"	16	+120°C	10	140	<b>21,86</b>
<b>07-146-0250-000</b>	1"	16	+120°C	8	80	<b>40,21</b>
<b>07-146-0320-000</b>	1 1/4"	16	+120°C	10	40	<b>59,17</b>
<b>07-146-0400-000</b>	1 1/2"	16	+120°C	2	20	<b>102,83</b>
<b>07-146-0500-000</b>	2"	16	+120°C	2	20	<b>170,05</b>



## 1046S

Śrubunek prosty o-ring mosiężny



B GRUPA RABATOWA

indeks	wielkość	PN	Tmax	pakowanie		cena netto [zł]
<b>07-146-0150-002</b>	1/2"	16	+120°C	18	270	<b>13,58</b>
<b>07-146-0200-002</b>	3/4"	16	+120°C	10	120	<b>22,34</b>
<b>07-146-0250-002</b>	1"	16	+120°C	8	80	<b>41,59</b>



## 1046A

Śrubunek prosty o-ring z gwintem samouszczel. mosiężny



B GRUPA RABATOWA

Produkt dostępny do wyczerpania zapasów

indeks	wielkość	PN	Tmax	pakowanie		cena netto [zł]
<b>07-146-0150-001</b>	1/2"	16	+120°C	20	200	<b>14,65</b>
<b>07-146-0200-001</b>	3/4"	16	+120°C	18	270	<b>22,85</b>
<b>07-146-0250-001</b>	1"	16	+120°C	10	140	<b>41,61</b>



## 1047

Śrubunek prosty stożek mosiężny



B GRUPA RABATOWA

indeks	wielkość	PN	Tmax	pakowanie		cena netto [zł]
<b>07-147-0100-000</b>	3/8"	16	+120°C	20	200	<b>10,40</b>
<b>07-147-0150-000</b>	1/2"	16	+120°C	18	270	<b>13,32</b>
<b>07-147-0200-000</b>	3/4"	16	+120°C	10	140	<b>21,86</b>
<b>07-147-0250-000</b>	1"	16	+120°C	8	80	<b>40,21</b>
<b>07-147-0320-000</b>	1 1/4"	16	+120°C	10	40	<b>59,17</b>
<b>07-147-0400-000</b>	1 1/2"	16	+120°C	5	25	<b>102,83</b>
<b>07-147-0500-000</b>	2"	16	+120°C	2	12	<b>170,05</b>



## 1048

Śrubunek kątowy o-ring mosiężny



B GRUPA RABATOWA

indeks	wielkość	PN	Tmax	pakowanie		cena netto [zł]
<b>07-148-0100-000</b>	3/8"	16	+120°C	20	200	<b>11,66</b>
<b>07-148-0150-000</b>	1/2"	16	+120°C	15	150	<b>19,54</b>
<b>07-148-0200-000</b>	3/4"	16	+120°C	10	60	<b>30,22</b>
<b>07-148-0250-000</b>	1"	16	+120°C	10	60	<b>51,93</b>
<b>07-148-0320-000</b>	1 1/4"	16	+120°C	10	40	<b>84,97</b>



## 1049

Śrubunek kątowy stożek mosiężny



B GRUPA RABATOWA

indeks	wielkość	PN	Tmax	pakowanie		cena netto [zł]
<b>07-149-0150-000</b>	1/2"	16	+120°C	15	180	<b>19,54</b>
<b>07-149-0200-000</b>	3/4"	16	+120°C	10	100	<b>30,22</b>
<b>07-149-0250-000</b>	1"	16	+120°C	10	60	<b>51,93</b>



## 5120

Śrubunek wodomierza mosiężny



D GRUPA RABATOWA

indeks	wielkość	PN	Tmax	pakowanie		cena netto [zł]
<b>07-190-0150-000</b>	1/2"	16	+90°C	30	150	<b>11,51</b>
<b>07-190-0200-000</b>	3/4"	16	+90°C	20	200	<b>16,20</b>
<b>07-190-0250-000</b>	1"	16	+90°C	10	100	<b>31,84</b>



**5120S**

Śrubunek wodomierza mosiężny



indeks	wielkość	PN	Tmax	pakowanie		cena netto [zł]
<b>07-190-0151-000</b>	½" L-36 mm	16	+90°C	2	200	<b>9,61</b>

**D** GRUPA RABATOWA**5122**

Śrubunek prosty z obrotową nakrętką



indeks	wielkość	PN	Tmax	pakowanie		cena netto [zł]
<b>07-150-0150-000</b>	½"	16	+90°C	1	200	<b>9,65</b>
<b>07-150-0200-000</b>	¾"	16	+90°C	1	150	<b>14,16</b>
<b>07-150-0250-000</b>	1"	16	+90°C	5	100	<b>22,63</b>

**B** GRUPA RABATOWA**U51**

Uszczelka płaska fibrowa do śrubunków wodomierza 5120 i 5120S



indeks	wielkość	pakowanie		cena netto [zł]
<b>28-001-0150-000</b>	½"	1	luz	<b>0,33</b>
<b>28-001-0200-000</b>	¾"	1	luz	<b>0,37</b>
<b>28-001-0250-000</b>	1"	1	luz	<b>0,44</b>

**D** GRUPA RABATOWA**5000**

Konsola wodomierza ze stali węglowej z powłoką malarską



indeks	wielkość	PN	Tmax	pakowanie		cena netto [zł]
<b>07-195-0150-000</b>	½"	16	+90°C	1	10	<b>128,36</b>
<b>07-195-0200-000</b>	¾"	16	+90°C	1	10	<b>157,94</b>

**D** GRUPA RABATOWA**5000N**

Konsola wodomierza ze stali nierdzewnej



indeks	wielkość	PN	Tmax	pakowanie		cena netto [zł]
<b>07-195-0150-001</b>	½"	16	+90°C	1	10	<b>166,87</b>
<b>07-195-0200-001</b>	¾"	16	+90°C	1	10	<b>196,43</b>

**D** GRUPA RABATOWA**5000N/A**

Konsola wodomierza ze stali nierdzewnej



indeks	wielkość	PN	Tmax	pakowanie		cena netto [zł]
<b>07-195-0200-002</b>	¾"	16	+90°C	1	10	<b>196,43</b>

**D** GRUPA RABATOWA**U46**

Uszczelka do śrubunków samuszczelniających 1046A



indeks	wielkość	pakowanie		cena netto [zł]
<b>28-000-0150-000</b>	½"	1	luz	<b>0,33</b>
<b>28-000-0200-000</b>	¾"	1	luz	<b>0,35</b>
<b>28-000-0250-000</b>	1"	1	luz	<b>0,58</b>

**B** GRUPA RABATOWA**U60**

Pierścień uszczelniający do śrubunków 1046 i 1046S oraz 1048



indeks	wielkość	pakowanie		cena netto [zł]
<b>28-002-0010-000</b>	¾"	1	luz	<b>0,22</b>
<b>28-002-0150-000</b>	½"	1	luz	<b>0,27</b>
<b>28-002-0200-000</b>	¾"	1	luz	<b>0,31</b>
<b>28-002-0250-000</b>	1"	1	luz	<b>0,33</b>

**B** GRUPA RABATOWA

## 502

Przedłużka mosiężna chromowana WZ



indeks	wielkość	PN	Tmax	pakowanie	cena netto [zł]
<b>07-521-1510-000</b>	½" x 10	16	+180°C	20 540	<b>5,21</b>
<b>07-521-1515-000</b>	½" x 15	16	+180°C	20 540	<b>6,23</b>
<b>07-521-1520-000</b>	½" x 20	16	+180°C	20 320	<b>7,24</b>
<b>07-521-1525-000</b>	½" x 25	16	+180°C	20 320	<b>8,78</b>
<b>07-521-1530-000</b>	½" x 30	16	+180°C	20 320	<b>10,01</b>
<b>07-521-1540-000</b>	½" x 40	16	+180°C	20 320	<b>12,77</b>
<b>07-521-1550-000</b>	½" x 50	16	+180°C	20 240	<b>15,55</b>
<b>07-521-1560-000</b>	½" x 60	16	+180°C	20 160	<b>18,68</b>
<b>07-521-1580-000</b>	½" x 80	16	+180°C	20 160	<b>24,12</b>
<b>07-521-1599-000</b>	½" x 100	16	+180°C	20 120	<b>30,03</b>
<b>07-521-2010-000</b>	¾" x 10	16	+180°C	20 320	<b>8,40</b>
<b>07-521-2020-000</b>	¾" x 20	16	+180°C	20 320	<b>12,75</b>
<b>07-521-2030-000</b>	¾" x 30	16	+180°C	20 320	<b>16,95</b>
<b>07-521-2040-000</b>	¾" x 40	16	+180°C	20 180	<b>21,32</b>
<b>07-521-2050-000</b>	¾" x 50	16	+180°C	20 180	<b>24,90</b>



GRUPA RABATOWA



## 520

Nypel mosiężny chromowany



indeks	wielkość	PN	Tmax	pakowanie	cena netto [zł]
<b>07-520-0100-000</b>	¾"	16	+180°C	20 1000	<b>3,44</b>
<b>07-520-0150-000</b>	½"	16	+180°C	20 1000	<b>5,08</b>
<b>07-520-0200-000</b>	¾"	16	+180°C	20 240	<b>7,89</b>



GRUPA RABATOWA



## 454

Mufa mosiężna chromowana



indeks	wielkość	PN	Tmax	pakowanie	cena netto [zł]
<b>07-454-0100-000</b>	¾"	16	+180°C	20 600	<b>6,35</b>
<b>07-454-0150-000</b>	½"	16	+180°C	20 240	<b>7,66</b>
<b>07-454-0200-000</b>	¾"	16	+180°C	20 240	<b>11,73</b>



GRUPA RABATOWA



## 511

Redukcja mosiężna chromowana



indeks	wielkość	PN	Tmax	pakowanie	cena netto [zł]
<b>07-511-1015-000</b>	¾" x ½"	16	+180°C	20 1000	<b>2,98</b>
<b>07-511-1520-000</b>	½" x ¾"	16	+180°C	20 600	<b>5,26</b>



GRUPA RABATOWA



## 512

Redukcja mosiężna chromowana z uszczelką



indeks	wielkość	PN	Tmax	pakowanie	cena netto [zł]
<b>07-512-1015-000</b>	¾" x ½"	16	+180°C	50 800	<b>4,22</b>



GRUPA RABATOWA



## 515

Nypel redukcyjny mosiężny chromowany



indeks	wielkość	PN	Tmax	pakowanie	cena netto [zł]
<b>07-515-1015-000</b>	¾" x ½"	16	+180°C	20 320	<b>4,41</b>
<b>07-515-1520-000</b>	½" x ¾"	16	+180°C	20 240	<b>7,36</b>



GRUPA RABATOWA



## 506

Redukcja mufowo-nypłowa mosiężna chromowana



indeks	wielkość	PN	Tmax	pakowanie	cena netto [zł]
<b>07-506-1015-000</b>	¾" x ½"	16	+180°C	20 800	<b>5,48</b>
<b>07-506-1520-000</b>	½" x ¾"	16	+180°C	20 480	<b>8,50</b>



GRUPA RABATOWA





**510**Redukcja mufowa  
mosiężna chromowana

indeks	wielkość	PN	Tmax	pakowanie	cena netto [zł]
<b>07-510-1015-000</b>	3/8" x 1/2"	16	+180°C	20 280	<b>6,59</b>
<b>07-510-1520-000</b>	1/2" x 3/4"	16	+180°C	20 480	<b>9,61</b>

**D** GRUPA RABATOWA**451**Kolano mosiężne  
chromowane WZ

indeks	wielkość	PN	Tmax	pakowanie	cena netto [zł]
<b>07-451-0100-000</b>	3/8"	16	+180°C	20 320	<b>8,09</b>
<b>07-451-0150-000</b>	1/2"	16	+180°C	20 360	<b>10,83</b>
<b>07-451-0200-000</b>	3/4"	16	+180°C	20 200	<b>17,86</b>

**D** GRUPA RABATOWA**452**Kolano mosiężne  
chromowane WW

indeks	wielkość	PN	Tmax	pakowanie	cena netto [zł]
<b>07-452-0100-000</b>	3/8"	16	+180°C	20 360	<b>8,13</b>
<b>07-452-0150-000</b>	1/2"	16	+180°C	20 480	<b>10,35</b>
<b>07-452-0200-000</b>	3/4"	16	+180°C	20 240	<b>17,69</b>

**D** GRUPA RABATOWA**453**Trójnik mosiężny  
chromowany

indeks	wielkość	PN	Tmax	pakowanie	cena netto [zł]
<b>07-453-0100-000</b>	3/8"	16	+180°C	20 480	<b>8,68</b>
<b>07-453-0150-000</b>	1/2"	16	+180°C	20 480	<b>12,38</b>
<b>07-453-0200-000</b>	3/4"	16	+180°C	20 280	<b>18,92</b>

**D** GRUPA RABATOWA**453WWZ**Trójnik mosiężny  
chromowany WWZ

indeks	wielkość	PN	Tmax	pakowanie	cena netto [zł]
<b>07-453-0150-001</b>	1/2"	16	+180°C	20 480	<b>17,78</b>

**D** GRUPA RABATOWA**1046CH**Śrubunek prosty o-ring  
mosiężny chromowany

indeks	wielkość	PN	Tmax	pakowanie	cena netto [zł]
<b>07-450-0100-000</b>	3/8"	16	+120°C	20 200	<b>11,40</b>
<b>07-450-0150-000</b>	1/2"	16	+120°C	18 280	<b>15,03</b>

**D** GRUPA RABATOWA**1048CH**Śrubunek kątowy o-ring  
mosiężny chromowany

indeks	wielkość	PN	Tmax	pakowanie	cena netto [zł]
<b>07-449-0150-000</b>	1/2"	16	+120°C	18 180	<b>15,24</b>
<b>07-449-0200-000</b>	3/4"	16	+120°C	10 100	<b>24,58</b>

**D** GRUPA RABATOWA**5101CH**Korek mosiężny  
chromowany GZ

indeks	wielkość	PN	Tmax	pakowanie	cena netto [zł]
<b>07-456-0150-000</b>	1/2"	16	+180°C	50 1000	<b>3,94</b>
<b>07-456-0200-000</b>	3/4"	16	+180°C	50 500	<b>6,32</b>

**D** GRUPA RABATOWA

**5102CH**

Zaślepka mosiężna chromowana



indeks	wielkość	PN	Tmax	pakowanie	cena netto [zł]
<b>07-457-0150-000</b>	1/2"	16	+180°C	50 800	<b>4,30</b>
<b>07-457-0200-000</b>	3/4"	16	+180°C	130 520	<b>6,18</b>

**D** GRUPA RABATOWA**PHA-351**

Przedłużka pod baterię ścienną mosiężna chromowana WZ

PERFEKT<sup>Q</sup>SYSTEM

indeks	wielkość	PN	Tmax	pakowanie	cena netto [zł]
<b>07-351-0200-000</b>	3/4"	16	+180°C	20 180	<b>17,71</b>

**D** GRUPA RABATOWA**PHA-352**

Trójnik typu "Y" mosiężny chromowany WZ

PERFEKT<sup>Q</sup>SYSTEM

indeks	wielkość	PN	Tmax	pakowanie	cena netto [zł]
<b>07-352-0150-000</b>	1/2"	16	+180°C	20 200	<b>20,44</b>

**D** GRUPA RABATOWA**TT**

Taśma teflonowa



indeks	wielkość	kolor taśmy	pakowanie	cena netto [zł]
<b>29-002-0000-000</b>	0,2 mm x 12 mm x 15 mb	niebieska	5 50	<b>11,42</b>
<b>29-003-0000-000</b>	0,2 mm x 19 mm x 15 mb	żółta	5 50	<b>10,37</b>
<b>29-004-0000-000</b>	0,2 mm x 25 mm x 15 mb	czerwona	5 50	<b>13,90</b>
<b>29-001-0002-000</b>	0,075 mm x 12mm x 10 mb	biała	10 250	<b>1,85</b>

**E** GRUPA RABATOWA**PHA-011**

Kurek kulowy z filtrem podłączeniowy, metalowe pokrętko

PERFEKT<sup>Q</sup>SYSTEM

indeks	wielkość	PN	Tmax	pakowanie	cena netto [zł]
<b>02-011-1510-000</b>	1/2" x 3/8"	16	+120°C	1 100	<b>26,43</b>
<b>02-011-1515-000</b>	1/2" x 1/2"	16	+120°C	1 100	<b>26,79</b>
<b>02-011-1520-000</b>	1/2" x 3/4"	16	+120°C	1 100	<b>28,25</b>

**K** GRUPA RABATOWA**PHA-012**

Kurek kulowy z filtrem podłączeniowy krótki, metalowe pokrętko

PERFEKT<sup>Q</sup>SYSTEM

indeks	wielkość	PN	Tmax	pakowanie	cena netto [zł]
<b>02-012-1510-000</b>	1/2" x 3/8"	16	+120°C	1 100	<b>23,71</b>
<b>02-012-1515-000</b>	1/2" x 1/2"	16	+120°C	1 100	<b>24,09</b>
<b>02-012-1520-000</b>	1/2" x 3/4"	16	+120°C	1 100	<b>25,69</b>

**K** GRUPA RABATOWA**PHA-0140**

Prolunga zawór grzybkowy podłączeniowy z obrotową nakrętką i przedłużką

PERFEKT<sup>Q</sup>SYSTEM

indeks	wielkość	PN	Tmax	pakowanie	cena netto [zł]
<b>02-014-0200-001</b>	3/4" x 3/4" x 3/4"	10	+90°C	1 150	<b>51,85</b>

**E** GRUPA RABATOWA**PHA-018**

Zawór grzybkowy podłączeniowy

PERFEKT<sup>Q</sup>SYSTEM

indeks	wielkość	PN	Tmax	pakowanie	cena netto [zł]
<b>02-018-1510-000</b>	1/2" x 3/8"	16	+120°C	20 200	<b>22,02</b>
<b>02-018-1515-000</b>	1/2" x 1/2"	16	+120°C	20 200	<b>22,33</b>
<b>02-018-1520-000</b>	1/2" x 3/4"	16	+120°C	20 200	<b>23,38</b>

**K** GRUPA RABATOWA

**PHA-050**Zawór kombinowany  
podłączeniowyPERFEKT<sup>SYSTEM</sup>

indeks	wielkość	PN	Tmax	pakowanie		cena netto [2]
<b>02-050-1520-000</b>	1/2" x 3/8" x 3/4"	10	+90°C	1	80	<b>54,54</b>

**(K)** GRUPA RABATOWA**PHA-051**Zawór podłączeniowy  
kątowy z ceramiczną  
głowicąPERFEKT<sup>SYSTEM</sup>

indeks	wielkość	PN	Tmax	pakowanie		cena netto [2]
<b>02-051-1510-000</b>	1/2" x 3/8"	10	+90°C	1	100	<b>33,14</b>
<b>02-051-1515-000</b>	1/2" x 1/2"	10	+90°C	1	100	<b>33,43</b>
<b>02-051-1520-000</b>	1/2" x 3/4"	10	+90°C	1	100	<b>34,42</b>

**(K)** GRUPA RABATOWA**PHA-052**Zawór podłączeniowy  
kątowy z ceramiczną  
głowicąPERFEKT<sup>SYSTEM</sup>

indeks	wielkość	PN	Tmax	pakowanie		cena netto [2]
<b>02-052-1510-000</b>	1/2" x 3/8"	10	+90°C	1	100	<b>30,59</b>
<b>02-052-1515-000</b>	1/2" x 1/2"	10	+90°C	1	100	<b>31,22</b>
<b>02-052-1520-000</b>	1/2" x 3/4"	10	+90°C	1	100	<b>32,76</b>

**(K)** GRUPA RABATOWA**PHA-055**Zawór kulowy antykamieny  
podłączeniowy,  
metalowe pokrętkoPERFEKT<sup>SYSTEM</sup>

indeks	wielkość	PN	Tmax	pakowanie		cena netto [2]
<b>02-055-1510-000</b>	1/2" x 3/8"	10	+90°C	1	100	<b>22,64</b>
<b>02-055-1515-000</b>	1/2" x 1/2"	10	+90°C	1	100	<b>23,08</b>
<b>02-055-1520-000</b>	1/2" x 3/4"	10	+90°C	1	100	<b>23,32</b>

**(K)** GRUPA RABATOWA**PHA-056**Zawór grzybkowy z filtrem  
podłączeniowyPERFEKT<sup>SYSTEM</sup>

indeks	wielkość	PN	Tmax	pakowanie		cena netto [2]
<b>02-056-1510-000</b>	1/2" x 3/8"	10	+90°C	1	100	<b>20,58</b>
<b>02-056-1515-000</b>	1/2" x 1/2"	10	+90°C	1	100	<b>20,87</b>

**(K)** GRUPA RABATOWA**3003**Zawór kulowy  
podłączeniowy

indeks	wielkość	PN	Tmax	pakowanie		cena netto [2]
<b>02-200-1510-000</b>	1/2" x 3/8"	16	+120°C	1	100	<b>15,90</b>
<b>02-200-1515-000</b>	1/2" x 1/2"	16	+120°C	1	100	<b>16,39</b>
<b>02-200-1520-000</b>	1/2" x 3/4"	16	+120°C	1	100	<b>16,89</b>

**(B)** GRUPA RABATOWA**3003S**Zawór kulowy  
podłączeniowy krótki

indeks	wielkość	PN	Tmax	pakowanie		cena netto [2]
<b>02-204-1510-000</b>	1/2" x 3/8"	10	+90°C	25	100	<b>14,49</b>

**(B)** GRUPA RABATOWA**3026**Kurek kulowy trójdrogowy  
podłączeniowy

indeks	wielkość	PN	Tmax	pakowanie		cena netto [2]
<b>02-302-1515-000</b>	1/2" x 1/2" x 3/4"	10	+90°C	1	200	<b>23,75</b>

**(E)** GRUPA RABATOWA

## PHA-9105

Przyłącze elastyczne w oplocie ze stali nierdzewnej WZ

**E** GRUPA RABATOWA

PERFEKT<sup>2</sup> SYSTEM

indeks	wielkość	DN	PN	Tmax	pakowanie	cena netto [zł]
06-000-1010-030	3/8" x 3/8" x 30	8	10	+70°C	10 200	11,32
06-000-1010-040	3/8" x 3/8" x 40	8	10	+70°C	10 150	11,70
06-000-1010-050	3/8" x 3/8" x 50	8	10	+70°C	10 100	12,62
06-000-1515-020	1/2" x 1/2" x 20	8	10	+70°C	10 200	11,15
06-000-1515-025	1/2" x 1/2" x 25	8	10	+70°C	10 260	11,52
06-000-1515-030	1/2" x 1/2" x 30	8	10	+70°C	10 200	11,98
06-000-1515-040	1/2" x 1/2" x 40	8	10	+70°C	10 150	12,99
06-000-1515-045	1/2" x 1/2" x 45	8	10	+70°C	10 150	13,52
06-000-1515-050	1/2" x 1/2" x 50	8	10	+70°C	10 150	14,10
06-000-1515-060	1/2" x 1/2" x 60	8	10	+70°C	10 100	15,10
06-000-1515-070	1/2" x 1/2" x 70	8	10	+70°C	10 100	16,89
06-000-1515-080	1/2" x 1/2" x 80	8	10	+70°C	10 100	17,75
06-000-1515-090	1/2" x 1/2" x 90	8	10	+70°C	10 90	19,55
06-000-1515-100	1/2" x 1/2" x 100	8	10	+70°C	10 100	20,66
06-000-1515-120	1/2" x 1/2" x 120	8	10	+70°C	10 70	21,92
06-000-1515-150	1/2" x 1/2" x 150	8	10	+70°C	10 50	24,85

## PHA-9110

Przyłącze elastyczne w oplocie ze stali nierdzewnej WW

**E** GRUPA RABATOWA

PERFEKT<sup>2</sup> SYSTEM

indeks	wielkość	DN	PN	Tmax	pakowanie	cena netto [zł]
06-001-1010-020	3/8" x 3/8" x 20	8	10	+70°C	10 200	10,14
06-001-1010-030	3/8" x 3/8" x 30	8	10	+70°C	10 200	10,96
06-001-1010-040	3/8" x 3/8" x 40	8	10	+70°C	10 150	12,14
06-001-1010-050	3/8" x 3/8" x 50	8	10	+70°C	10 150	13,17
06-001-1010-060	3/8" x 3/8" x 60	8	10	+70°C	10 100	14,43
06-001-1510-020	1/2" x 3/8" x 20	8	10	+70°C	10 200	10,87
06-001-1510-030	1/2" x 3/8" x 30	8	10	+70°C	10 200	11,52
06-001-1510-040	1/2" x 3/8" x 40	8	10	+70°C	10 150	12,81
06-001-1510-050	1/2" x 3/8" x 50	8	10	+70°C	10 150	14,10
06-001-1510-060	1/2" x 3/8" x 60	8	10	+70°C	10 100	14,98
06-001-1515-020	1/2" x 1/2" x 20	8	10	+70°C	10 200	10,58
06-001-1515-025	1/2" x 1/2" x 25	8	10	+70°C	10 200	11,15
06-001-1515-030	1/2" x 1/2" x 30	8	10	+70°C	10 200	11,90
06-001-1515-035	1/2" x 1/2" x 35	8	10	+70°C	10 200	12,43
06-001-1515-040	1/2" x 1/2" x 40	8	10	+70°C	10 150	12,81
06-001-1515-045	1/2" x 1/2" x 45	8	10	+70°C	10 150	13,24
06-001-1515-050	1/2" x 1/2" x 50	8	10	+70°C	10 150	13,72
06-001-1515-055	1/2" x 1/2" x 55	8	10	+70°C	10 140	14,16
06-001-1515-060	1/2" x 1/2" x 60	8	10	+70°C	10 100	14,62
06-001-1515-070	1/2" x 1/2" x 70	8	10	+70°C	10 100	16,08
06-001-1515-080	1/2" x 1/2" x 80	8	10	+70°C	10 100	16,65
06-001-1515-090	1/2" x 1/2" x 90	8	10	+70°C	10 100	18,29
06-001-1515-100	1/2" x 1/2" x 100	8	10	+70°C	10 80	19,47
06-001-1515-120	1/2" x 1/2" x 120	8	10	+70°C	10 50	21,55
06-001-1515-150	1/2" x 1/2" x 150	8	10	+70°C	10 50	25,58

## PHA-9125

Przyłącze elastyczne w oplocie ze stali nierdzewnej WW

**E** GRUPA RABATOWA

PERFEKT<sup>2</sup> SYSTEM

indeks	wielkość	DN	PN	Tmax	pakowanie	cena netto [zł]
06-002-1520-030	1/2" x 3/4" x 30	8	10	+70°C	10 270	14,55
06-002-1520-040	1/2" x 3/4" x 40	8	10	+70°C	10 160	15,77
06-002-1520-050	1/2" x 3/4" x 50	8	10	+70°C	10 140	17,55
06-002-2020-030	3/4" x 3/4" x 30	8	10	+70°C	10 220	22,81
06-002-2020-040	3/4" x 3/4" x 40	8	10	+70°C	10 160	24,91
06-002-2020-050	3/4" x 3/4" x 50	8	10	+70°C	10 140	28,12

**PHA-9126**Przyłącze elastyczne z kolankiem  
w oplocie ze stali nierdzewnej WW**E** GRUPA RABATOWA**PERFEKT<sup>2</sup>SYSTEM**

indeks	wielkość	DN	PN	Tmax	pakowanie		cena netto [zł]
<b>06-005-1515-040</b>	½" x ½" x 40	8	10	+70°C	1	120	<b>30,61</b>
<b>06-005-1515-050</b>	½" x ½" x 50	8	10	+70°C	1	100	<b>32,68</b>
<b>06-005-1515-060</b>	½" x ½" x 60	8	10	+70°C	1	100	<b>34,74</b>
<b>06-005-1515-080</b>	½" x ½" x 80	8	10	+70°C	1	70	<b>38,90</b>
<b>06-005-1515-100</b>	½" x ½" x 100	8	10	+70°C	1	60	<b>42,88</b>
<b>06-005-1515-120</b>	½" x ½" x 120	8	10	+70°C	1	50	<b>47,02</b>
<b>06-005-1515-150</b>	½" x ½" x 150	8	10	+70°C	1	40	<b>51,16</b>

**PHA-9145/C**Przyłącze elastyczne do baterii  
w oplocie ze stali nierdzewnej, krótkie**E** GRUPA RABATOWA**PERFEKT<sup>2</sup>SYSTEM**

indeks	wielkość	DN	PN	Tmax	pakowanie		cena netto [zł]
<b>06-003-1010-030</b>	M10x1 x ¾" x 30	8	10	+70°C	10	200	<b>10,24</b>
<b>06-003-1010-040</b>	M10x1 x ¾" x 40	8	10	+70°C	10	150	<b>11,08</b>
<b>06-003-1010-050</b>	M10x1 x ¾" x 50	8	10	+70°C	10	240	<b>12,08</b>
<b>06-003-1010-060</b>	M10x1 x ¾" x 60	8	10	+70°C	10	100	<b>13,08</b>
<b>06-003-1010-080</b>	M10x1 x ¾" x 80	8	10	+70°C	10	100	<b>13,74</b>
<b>06-003-1510-030</b>	M10x1 x ½" x 30	8	10	+70°C	10	300	<b>10,33</b>
<b>06-003-1510-035</b>	M10x1 x ½" x 35	8	10	+70°C	10	150	<b>10,87</b>
<b>06-003-1510-040</b>	M10x1 x ½" x 40	8	10	+70°C	10	150	<b>11,41</b>
<b>06-003-1510-050</b>	M10x1 x ½" x 50	8	10	+70°C	10	100	<b>12,47</b>
<b>06-003-1510-060</b>	M10x1 x ½" x 60	8	10	+70°C	10	100	<b>13,59</b>
<b>06-003-1510-070</b>	M10x1 x ½" x 70	8	10	+70°C	10	200	<b>14,64</b>
<b>06-003-1510-080</b>	M10x1 x ½" x 80	8	10	+70°C	10	130	<b>15,75</b>

**PHA-9155 wąż antywibracyjny**Przyłącze w oplocie ze stali  
nierdzewnej WW**K** GRUPA RABATOWA**PERFEKT<sup>2</sup>SYSTEM**

indeks	wielkość	DN	PN	Tmax	pakowanie		cena netto [zł]
<b>06-011-0150-030</b>	½" x 30	13	12	+110°C	1	1	<b>30,74</b>
<b>06-011-0150-040</b>	½" x 40	13	12	+110°C	1	1	<b>33,15</b>
<b>06-011-0150-050</b>	½" x 50	13	12	+110°C	1	1	<b>35,58</b>
<b>06-011-0150-060</b>	½" x 60	13	12	+110°C	1	1	<b>37,96</b>
<b>06-011-0200-030</b>	¾" x 30	18	12	+110°C	1	1	<b>50,93</b>
<b>06-011-0200-040</b>	¾" x 40	18	12	+110°C	1	1	<b>54,80</b>
<b>06-011-0200-050</b>	¾" x 50	18	12	+110°C	1	1	<b>58,64</b>
<b>06-011-0200-060</b>	¾" x 60	18	12	+110°C	1	1	<b>62,52</b>
<b>06-011-0200-070</b>	¾" x 70	18	12	+110°C	1	1	<b>66,40</b>
<b>06-011-0200-080</b>	¾" x 80	18	12	+110°C	1	1	<b>70,25</b>
<b>06-011-0200-090</b>	¾" x 90	18	12	+110°C	1	1	<b>74,13</b>
<b>06-011-0200-100</b>	¾" x 100	18	12	+110°C	1	1	<b>77,98</b>
<b>06-011-0200-120</b>	¾" x 120	18	12	+110°C	1	1	<b>85,65</b>
<b>06-011-0200-150</b>	¾" x 150	18	12	+110°C	1	1	<b>97,27</b>
<b>06-011-0250-030</b>	1" x 30	25	10	+110°C	1	1	<b>69,49</b>
<b>06-011-0250-040</b>	1" x 40	25	10	+110°C	1	1	<b>74,09</b>
<b>06-011-0250-050</b>	1" x 50	25	10	+110°C	1	1	<b>78,59</b>
<b>06-011-0250-060</b>	1" x 60	25	10	+110°C	1	1	<b>83,16</b>
<b>06-011-0250-070</b>	1" x 70	25	10	+110°C	1	1	<b>87,76</b>
<b>06-011-0250-080</b>	1" x 80	25	10	+110°C	1	1	<b>92,31</b>
<b>06-011-0250-090</b>	1" x 90	25	10	+110°C	1	1	<b>96,82</b>
<b>06-011-0250-100</b>	1" x 100	25	10	+110°C	1	1	<b>101,40</b>
<b>06-011-0250-120</b>	1" x 120	25	10	+110°C	1	1	<b>116,97</b>
<b>06-011-0250-150</b>	1" x 150	25	10	+110°C	1	1	<b>131,46</b>
<b>06-011-0320-030</b>	1¼" x 30	32	10	+110°C	1	1	<b>236,59</b>
<b>06-011-0320-040</b>	1¼" x 40	32	10	+110°C	1	1	<b>259,02</b>
<b>06-011-0320-050</b>	1¼" x 50	32	10	+110°C	1	1	<b>281,45</b>
<b>06-011-0320-060</b>	1¼" x 60	32	10	+110°C	1	1	<b>303,83</b>
<b>06-011-0320-070</b>	1¼" x 70	32	10	+110°C	1	1	<b>326,25</b>
<b>06-011-0320-080</b>	1¼" x 80	32	10	+110°C	1	1	<b>348,67</b>

**PHA-9150 wąż antywibracyjny**

Przyłącze elastyczne w oplocie ze stali nierdzewnej WZ

**(K)** GRUPA RABATOWA**PERFEKT<sup>2</sup> SYSTEM**

indeks	wielkość	DN	PN	Tmax	pakowanie	cena netto [zł]
<b>06-010-0150-030</b>	½" x 30	13	12	+110°C	1 1	<b>32,15</b>
<b>06-010-0150-040</b>	½" x 40	13	12	+110°C	1 1	<b>34,80</b>
<b>06-010-0150-050</b>	½" x 50	13	12	+110°C	1 1	<b>37,32</b>
<b>06-010-0150-060</b>	½" x 60	13	12	+110°C	1 1	<b>39,83</b>
<b>06-010-0200-030</b>	¾" x 30	18	12	+110°C	1 1	<b>53,48</b>
<b>06-010-0200-040</b>	¾" x 40	18	12	+110°C	1 1	<b>57,54</b>
<b>06-010-0200-050</b>	¾" x 50	18	12	+110°C	1 1	<b>61,58</b>
<b>06-010-0200-060</b>	¾" x 60	18	12	+110°C	1 1	<b>65,66</b>
<b>06-010-0200-070</b>	¾" x 70	18	12	+110°C	1 1	<b>69,72</b>
<b>06-010-0200-080</b>	¾" x 80	18	12	+110°C	1 1	<b>73,76</b>
<b>06-010-0200-090</b>	¾" x 90	18	12	+110°C	1 1	<b>77,83</b>
<b>06-010-0200-100</b>	¾" x 100	18	12	+110°C	1 1	<b>81,87</b>
<b>06-010-0200-120</b>	¾" x 120	18	12	+110°C	1 1	<b>90,00</b>
<b>06-010-0200-150</b>	¾" x 150	18	12	+110°C	1 1	<b>102,18</b>
<b>06-010-0250-030</b>	1" x 30	25	10	+110°C	1 1	<b>73,00</b>
<b>06-010-0250-040</b>	1" x 40	25	10	+110°C	1 1	<b>77,81</b>
<b>06-010-0250-050</b>	1" x 50	25	10	+110°C	1 1	<b>82,52</b>
<b>06-010-0250-060</b>	1" x 60	25	10	+110°C	1 1	<b>87,33</b>
<b>06-010-0250-070</b>	1" x 70	25	10	+110°C	1 1	<b>92,15</b>
<b>06-010-0250-080</b>	1" x 80	25	10	+110°C	1 1	<b>96,93</b>
<b>06-010-0250-090</b>	1" x 90	25	10	+110°C	1 1	<b>101,65</b>
<b>06-010-0250-100</b>	1" x 100	25	10	+110°C	1 1	<b>106,46</b>
<b>06-010-0250-120</b>	1" x 120	25	10	+110°C	1 1	<b>122,84</b>
<b>06-010-0250-150</b>	1" x 150	25	10	+110°C	1 1	<b>138,01</b>
<b>06-010-0320-030</b>	1¼" x 30	32	10	+110°C	1 1	<b>248,45</b>
<b>06-010-0320-040</b>	1¼" x 40	32	10	+110°C	1 1	<b>272,00</b>
<b>06-010-0320-050</b>	1¼" x 50	32	10	+110°C	1 1	<b>295,51</b>
<b>06-010-0320-060</b>	1¼" x 60	32	10	+110°C	1 1	<b>319,02</b>
<b>06-010-0320-070</b>	1¼" x 70	32	10	+110°C	1 1	<b>342,58</b>
<b>06-010-0320-080</b>	1¼" x 80	32	10	+110°C	1 1	<b>366,10</b>

**PHA-9156 wąż antywibracyjny**

Przyłącze w oplocie ze stali nierdzewnej z kolankiem WZ

**(K)** GRUPA RABATOWA**PERFEKT<sup>2</sup> SYSTEM**

indeks	wielkość	DN	PN	Tmax	pakowanie	cena netto [zł]
<b>06-012-0250-040</b>	1" x 40	25	10	+110°C	1 1	<b>77,02</b>
<b>06-012-0250-050</b>	1" x 50	25	10	+110°C	1 1	<b>81,66</b>
<b>06-012-0250-060</b>	1" x 60	25	10	+110°C	1 1	<b>86,38</b>
<b>06-012-0250-070</b>	1" x 70	25	10	+110°C	1 1	<b>91,08</b>
<b>06-012-0250-080</b>	1" x 80	25	10	+110°C	1 1	<b>95,70</b>
<b>06-012-0250-090</b>	1" x 90	25	10	+110°C	1 1	<b>100,41</b>
<b>06-012-0250-100</b>	1" x 100	25	10	+110°C	1 1	<b>105,11</b>
<b>06-012-0250-120</b>	1" x 120	25	10	+110°C	1 1	<b>114,47</b>
<b>06-012-0250-150</b>	1" x 150	25	10	+110°C	1 1	<b>128,52</b>

**PHA-9145/L**

Przyłącze elastyczne do baterii w oplocie ze stali nierdzewnej, długie

**(E)** GRUPA RABATOWA**PERFEKT<sup>2</sup> SYSTEM**

indeks	wielkość	DN	PN	Tmax	pakowanie	cena netto [zł]
<b>06-004-1010-030</b>	M10x1 x ¾" x 30	8	10	+70°C	10 200	<b>11,15</b>
<b>06-004-1010-040</b>	M10x1 x ¾" x 40	8	10	+70°C	10 150	<b>12,18</b>
<b>06-004-1010-050</b>	M10x1 x ¾" x 50	8	10	+70°C	10 150	<b>13,21</b>
<b>06-004-1010-060</b>	M10x1 x ¾" x 60	8	10	+70°C	10 100	<b>14,22</b>
<b>06-004-1010-080</b>	M10x1 x ¾" x 80	8	10	+70°C	10 100	<b>16,22</b>
<b>06-004-1510-030</b>	M10x1 x ½" x 30	8	10	+70°C	10 200	<b>11,63</b>
<b>06-004-1510-040</b>	M10x1 x ½" x 40	8	10	+70°C	10 150	<b>12,74</b>
<b>06-004-1510-050</b>	M10x1 x ½" x 50	8	10	+70°C	10 150	<b>13,80</b>
<b>06-004-1510-060</b>	M10x1 x ½" x 60	8	10	+70°C	10 100	<b>14,91</b>
<b>06-004-1510-070</b>	M10x1 x ½" x 70	8	10	+70°C	10 100	<b>16,00</b>
<b>06-004-1510-080</b>	M10x1 x ½" x 80	8	10	+70°C	10 100	<b>17,09</b>





# PERFEXIM

## CENNIK ARMATURA 2024



Produkty spełniające surowe wymagania wyrobów przeznaczonych do instalacji gazowych

### PERFEKT<sup>2</sup> SYSTEM

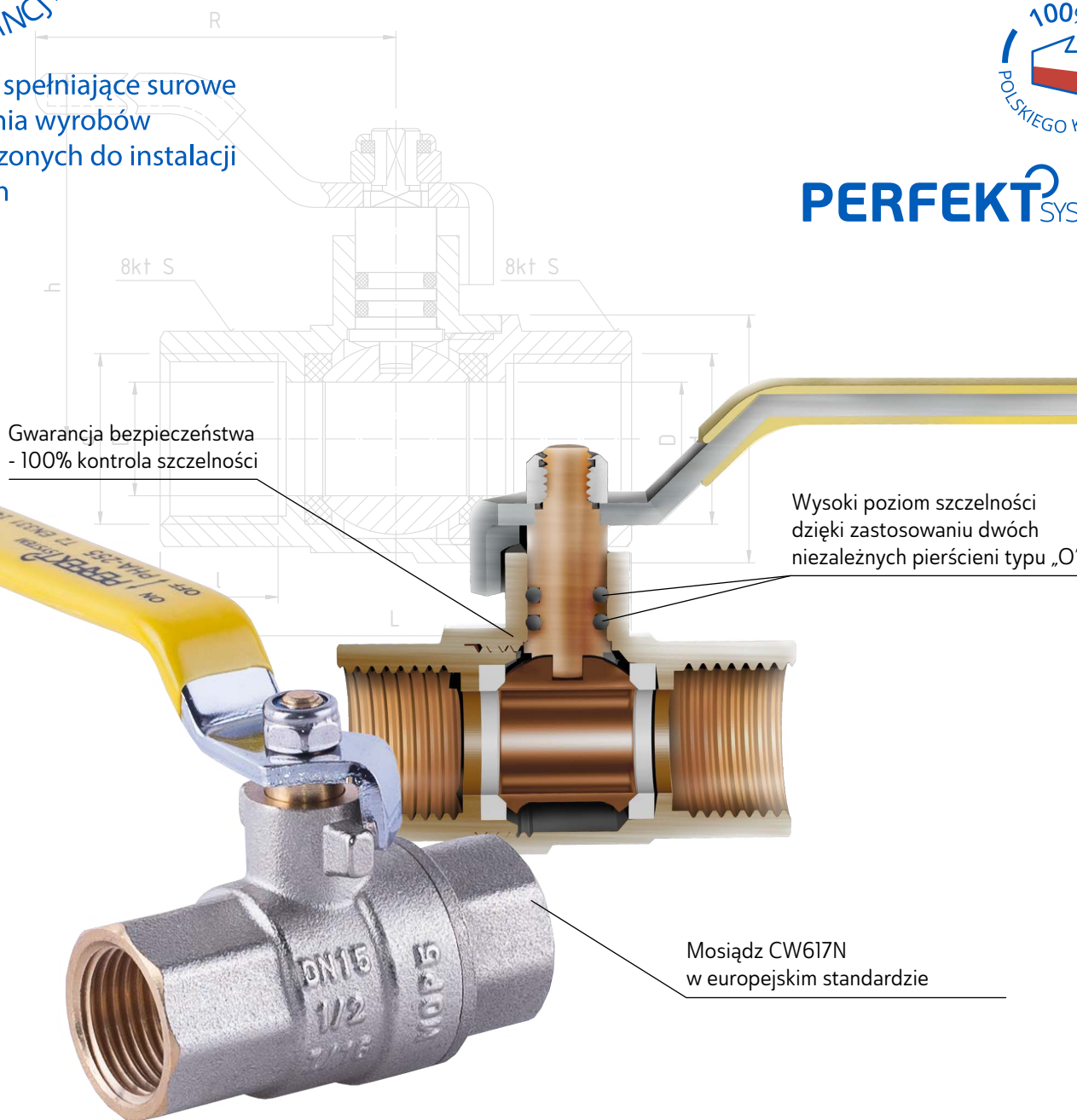

Gwarancja bezpieczeństwa  
- 100% kontrola szczelności

Wysoki poziom szczelności  
dzięki zastosowaniu dwóch  
niezależnych pierścieni typu „O”

Mosiądz CW617N  
w europejskim standardzie

# ARMATURA GAZOWA

Kurki kulowe	33
Filtry	33
Przyłącza	33



**PHA-255****PERFEKT SYSTEM**Kurek kulowy do gazu WW,  
MOP5 T2

C GRUPA RABATOWA

**PERFEKT<sup>2</sup>SYSTEM**

indeks	wielkość	pakowanie		cena netto [zł]
		☞	☞	
<b>10-255-0150-000</b>	½"	16	144	<b>29,46</b>
<b>10-255-0200-000</b>	¾"	10	90	<b>46,91</b>
<b>10-255-0250-000</b>	1"	8	64	<b>74,00</b>
<b>10-255-0320-000</b>	1¼"	4	32	<b>121,49</b>
<b>10-255-0400-000</b>	1½"	2	18	<b>166,80</b>
<b>10-255-0500-000</b>	2"	2	16	<b>284,18</b>

**PHA-260****PERFEKT SYSTEM**Filtr skośny do gazu,  
MOP5 T2

C GRUPA RABATOWA

**PERFEKT<sup>2</sup>SYSTEM**

indeks	wielkość	pakowanie		cena netto [zł]
		☞	☞	
<b>10-260-0150-000</b>	½"	12	168	<b>27,04</b>
<b>10-260-0200-000</b>	¾"	8	96	<b>44,53</b>
<b>10-260-0250-000</b>	1"	7	63	<b>59,98</b>
<b>10-260-0320-000</b>	1¼"	4	32	<b>119,21</b>
<b>10-260-0400-000</b>	1½"	2	18	<b>150,23</b>
<b>10-260-0500-000</b>	2"	2	16	<b>240,32</b>

**PHA-250/2****PERFEKT SYSTEM**Bezpieczny metalowy  
przewód przyłączeniowy  
WW Typ 1

K GRUPA RABATOWA

**PERFEKT<sup>2</sup>SYSTEM**

indeks	rozmiar	pakowanie		cena netto [zł]
		☞	☞	
<b>11-016-0500-000</b>	500	1	200	<b>63,73</b>
<b>11-016-0750-000</b>	750	1	200	<b>68,32</b>
<b>11-016-1000-000</b>	1000	1	175	<b>71,49</b>
<b>11-016-1250-000</b>	1250	1	150	<b>83,45</b>
<b>11-016-1500-000</b>	1500	1	125	<b>94,61</b>
<b>11-016-2000-000</b>	2000	1	100	<b>113,00</b>

**PHA-251/2****PERFEKT SYSTEM**Bezpieczny metalowy  
przewód przyłączeniowy  
WZ do gazu Typ1

K GRUPA RABATOWA

**PERFEKT<sup>2</sup>SYSTEM**

indeks	rozmiar	pakowanie		cena netto [zł]
		☞	☞	
<b>11-017-0500-000</b>	500	1	200	<b>63,73</b>
<b>11-017-0750-000</b>	750	1	200	<b>68,32</b>
<b>11-017-1000-000</b>	1000	1	175	<b>71,49</b>
<b>11-017-1250-000</b>	1250	1	150	<b>83,45</b>
<b>11-017-1500-000</b>	1500	1	125	<b>94,61</b>
<b>11-017-2000-000</b>	2000	1	100	<b>113,00</b>

**Przewód rozciągliwy**Przewód rozciągliwy  
do gazu WZ

K GRUPA RABATOWA

indeks	rozmiar	zakres długości	PN	DN	Tmax	pakowanie		cena netto [zł]
						☞	☞	
<b>11-012-0130-000</b>	½" x ½"	130-220mm	5	16	+120°C	1	50	<b>40,57</b>
<b>11-012-0220-000</b>	½" x ½"	220-420mm	5	16	+120°C	1	40	<b>47,34</b>
<b>11-012-0300-000</b>	½" x ½"	300-600mm	5	16	+120°C	1	50	<b>58,15</b>
<b>11-012-0500-000</b>	½" x ½"	500-1000mm	5	16	+120°C	1	40	<b>75,72</b>
<b>11-012-0750-000</b>	½" x ½"	750-1500mm	5	16	+120°C	1	50	<b>87,89</b>
<b>11-013-0130-000</b>	¾" x ¾"	130-220mm	5	20	+120°C	1	50	<b>63,55</b>
<b>11-013-0220-000</b>	¾" x ¾"	220-420mm	5	20	+120°C	1	50	<b>74,37</b>
<b>11-013-0300-000</b>	¾" x ¾"	300-600mm	5	20	+120°C	1	40	<b>87,89</b>
<b>11-013-0500-000</b>	¾" x ¾"	500-1000mm	5	20	+120°C	1	30	<b>112,23</b>
<b>11-013-0750-000</b>	¾" x ¾"	750-1500mm	5	20	+120°C	1	30	<b>120,35</b>
<b>11-013-1000-000</b>	¾" x ¾"	1000-2000mm	5	20	+120°C	1	30	<b>129,82</b>



Profesjonalne  
rozdzielenie ciepła

# PERFEXIM

CENNIK ARMATURA 2024



93.5

PERFEKT<sup>2</sup> SYSTEM

Ochrona zdrowotna i antyalergiczna  
- brak niklu na powierzchniach  
mających kontakt z wodą pitną

Ułatwienie prac instalatorskich  
przez różne konfiguracje  
spełniające oczekiwania

Stal nierdzewna gatunku 1.4301  
o europejskim standardzie

# ARMATURA CENTRALNEGO OGRZEWANIA

34-54

System antyzamroziowy	35
Komplety / głowice termostatyczne	35
Zawory grzejnikowe	39
Zawory bezpieczeństwa	42
Pompy obiegowe	43
Rozdzielacze, osprzęt rozdzielaczy	44
Zawory odpowietrzające	53
Automatyka ogrzewania	54
Uchwyty do bojlerów	54

**PHA-SAZ/2**

System antyzamrozieniowy do pomp ciepła typu monoblok

**PERFEKT<sup>2</sup>SYSTEM**

indeks	pakowanie	cena netto [zł]
58-000-0000-000	1 1	1900,00
58-000-0000-100	1 1	2100,00

(K) GRUPA RABATOWA

**PHA-024**

Komplet termostatyczny prosty

**PERFEKT<sup>2</sup>SYSTEM**

indeks	wielkość	PN	kolor	Tmax	pakowanie	cena netto [zł]
20-024-0000-000	½"	10	chrom	+120°C	1 30	107,61

(K) GRUPA RABATOWA

**PHA-024W**

Komplet termostatyczny prosty

**PERFEKT<sup>2</sup>SYSTEM**

indeks	wielkość	PN	kolor	Tmax	pakowanie	cena netto [zł]
20-024-0000-001	½"	10	biały	+120°C	1 30	118,25

(K) GRUPA RABATOWA

**PHA-025**

Komplet termostatyczny kątowy

**PERFEKT<sup>2</sup>SYSTEM**

indeks	wielkość	PN	kolor	Tmax	pakowanie	cena netto [zł]
20-025-0000-000	½"	10	chrom	+120°C	1 30	113,00

(K) GRUPA RABATOWA

**PHA-025W**

Komplet termostatyczny kątowy

**PERFEKT<sup>2</sup>SYSTEM**

indeks	wielkość	PN	kolor	Tmax	pakowanie	cena netto [zł]
20-025-0000-001	½"	10	biały	+120°C	1 30	118,25

(K) GRUPA RABATOWA

**PHA-026**

Komplet termostatyczny z nastawą wstępną, prosty

**PERFEKT<sup>2</sup>SYSTEM**

indeks	wielkość	PN	Tmax	pakowanie	cena netto [zł]
20-026-0000-000	½"	10	+120°C	1 1	109,08

(K) GRUPA RABATOWA

**PHA-027**

Komplet termostatyczny z nastawą wstępną, kątowy

**PERFEKT<sup>2</sup>SYSTEM**

indeks	wielkość	PN	Tmax	pakowanie	cena netto [zł]
20-027-0000-000	½"	10	+120°C	1 1	109,08

(K) GRUPA RABATOWA

## PHA-036

Zintegrowany zestaw termostatyczny z nastawą wstępną, kątowy



**(K)** GRUPA RABATOWA



chromowany



biały



grafit



czarny mat



czarny struktura

PERFEKT<sup>SYSTEM</sup>

indeks	wielkość	PN	kolor	Tmax	pakowanie		cena netto [zł]
<b>20-036-0000-000</b>	½"	10	chrom	+120°C	1	20	<b>202,15</b>
<b>20-036-0000-001</b>	½"	10	biały	+120°C	1	20	<b>207,20</b>
<b>20-036-0000-002</b>	½"	10	grafit	+120°C	1	20	<b>224,89</b>
<b>20-036-0000-003</b>	½"	10	czarny mat	+120°C	1	20	<b>224,89</b>
<b>20-036-0000-004</b>	½"	10	czarny struktura	+120°C	1	20	<b>224,89</b>

## PHA-037

Komplet termostatyczny z nastawą wstępną "lewy"



**(K)** GRUPA RABATOWA



chromowany



biały



grafit



czarny mat



czarny struktura

PERFEKT<sup>SYSTEM</sup>

indeks	wielkość	PN	kolor	Tmax	pakowanie		cena netto [zł]
<b>20-037-0000-000</b>	½"	10	chrom	+120°C	1	20	<b>199,62</b>
<b>20-037-0000-001</b>	½"	10	biały	+120°C	1	20	<b>202,15</b>
<b>20-037-0000-002</b>	½"	10	grafit	+120°C	1	20	<b>214,79</b>
<b>20-037-0000-003</b>	½"	10	czarny mat	+120°C	1	20	<b>214,79</b>
<b>20-037-0000-004</b>	½"	10	czarny struktura	+120°C	1	20	<b>214,79</b>

## PHA-038

Komplet termostatyczny z nastawą wstępną "prawy"



**(K)** GRUPA RABATOWA



chromowany



biały



grafit



czarny mat



czarny struktura

PERFEKT<sup>SYSTEM</sup>

indeks	wielkość	PN	kolor	Tmax	pakowanie		cena netto [zł]
<b>20-038-0000-000</b>	½"	10	chrom	+120°C	1	20	<b>199,62</b>
<b>20-038-0000-001</b>	½"	10	biały	+120°C	1	20	<b>202,15</b>
<b>20-038-0000-002</b>	½"	10	grafit	+120°C	1	20	<b>214,79</b>
<b>20-038-0000-003</b>	½"	10	czarny mat	+120°C	1	20	<b>214,79</b>
<b>20-038-0000-004</b>	½"	10	czarny struktura	+120°C	1	20	<b>214,79</b>

## 7024

Komplet termostatyczny prosty z głowicą z blokadą nastawy



**(E)** GRUPA RABATOWA

indeks	PN	Tmax	pakowanie		cena netto [zł]
<b>20-107-0200-000</b>	10	+120°C	1	40	<b>94,74</b>

## 7025

Komplet termostatyczny kątowy z głowicą z blokadą nastawy



**(E)** GRUPA RABATOWA

indeks	PN	Tmax	pakowanie		cena netto [zł]
<b>20-107-0200-010</b>	10	+120°C	1	40	<b>94,74</b>

## 7030

Komplet kątowy do podłączenia grzejnika, chromowany



**(E)** GRUPA RABATOWA

indeks	wielkość	PN	Tmax	pakowanie		cena netto [zł]
<b>20-108-0100-000</b>	½"	10	+120°C	1	55	<b>100,15</b>

## 7031

Komplet kątowy do podłączenia grzejnika, biały, wypukłe pokrętko



indeks	wielkość	PN	Tmax	pakowanie	cena netto [zł]
<b>20-108-0100-001</b>	½"	10	+120°C	1 55	<b>100,15</b>

**E** GRUPA RABATOWA

## 7032

Komplet kątowy do podłączenia grzejnika, wypukłe pokrętko



indeks	wielkość	PN	kolor	Tmax	pakowanie	cena netto [zł]
<b>20-108-0100-002</b>	½"	10	grafit	+120°C	1 55	<b>103,53</b>
<b>20-108-0100-003</b>	½"	10	czarny mat	+120°C	1 55	<b>103,53</b>
<b>20-108-0100-004</b>	½"	10	czarny struktura	+120°C	1 55	<b>103,53</b>

**E** GRUPA RABATOWA

## ZM02

Zestaw maskujący do grzejników z dwiema rozetami okrągłymi i tulejami



indeks	kolor	pakowanie	cena netto [zł]
<b>20-040-1000-200</b>	chrom	1 48	<b>38,85</b>
<b>20-040-1000-201</b>	biały	1 48	<b>38,85</b>
<b>20-040-1000-203</b>	czarny mat	1 48	<b>38,85</b>

**K** GRUPA RABATOWA



chrom



biały



czarny mat

## ZMK2

Zestaw maskujący do grzejników z dwiema rozetami kwadratowymi i tulejami



indeks	kolor	pakowanie	cena netto [zł]
<b>20-040-1020-200</b>	chrom	1 48	<b>57,75</b>
<b>20-040-1020-201</b>	biały	1 48	<b>57,75</b>
<b>20-040-1020-203</b>	czarny mat	1 48	<b>57,75</b>

**K** GRUPA RABATOWA



chrom



biały



czarny mat

## ZM01

Zestaw maskujący do grzejników z rozetą owalną i tulejami



indeks	kolor	pakowanie	cena netto [zł]
<b>20-040-1040-100</b>	chrom	1 48	<b>38,85</b>
<b>20-040-1040-101</b>	biały	1 48	<b>38,85</b>
<b>20-040-1040-103</b>	czarny mat	1 48	<b>38,85</b>

**K** GRUPA RABATOWA



chrom



biały



czarny mat

## ZMK1

Zestaw maskujący do grzejników z rozetą prostokątną i tulejami



indeks	kolor	pakowanie	cena netto [zł]
<b>20-040-1030-100</b>	chrom	1 48	<b>57,75</b>
<b>20-040-1030-101</b>	biały	1 48	<b>57,75</b>
<b>20-040-1030-103</b>	czarny mat	1 48	<b>57,75</b>

**K** GRUPA RABATOWA



chrom



biały



czarny mat

**TRCD10C**

Głowica termostatyczna cieczowa M30x1.5, chromowana



indeks	Tmax	pakowanie	cena netto [zł]
<b>20-107-0400-000</b>	+50°C	1 100	<b>38,23</b>

**E** GRUPA RABATOWA

**TRCD10**

Głowica termostatyczna cieczowa M30x1.5, biała



indeks	kolor	Tmax	pakowanie	cena netto [zł]
<b>20-107-0400-100</b>	biały	+50°C	1 100	<b>39,74</b>
<b>20-107-0400-003</b>	czarny mat	+50°C	1 100	<b>37,49</b>

**E** GRUPA RABATOWA



biały



czarny mat

**TRCD15**

Głowica termostatyczna cieczowa M30x1.5 z blokadą nastawy



indeks	Tmax	pakowanie	cena netto [zł]
<b>20-107-0300-000</b>	+50°C	1 100	<b>33,46</b>

**E** GRUPA RABATOWA

**GT01RA**

Głowica termostatyczna cieczowa z przyłączem RA z blokadą nastawy temperatury



dostępne w III kwartale 2024

indeks	Tmax	pakowanie	cena netto [zł]
<b>20-300-0009-000</b>	+50°C	1 100	

**E** GRUPA RABATOWA

**GT02RA**

Głowica termostatyczna cieczowa z przyłączem RA



dostępne w III kwartale 2024

indeks	Tmax	pakowanie	cena netto [zł]
<b>20-300-0010-000</b>	+50°C	1 100	

**E** GRUPA RABATOWA

**GT01**

Głowica termostatyczna cieczowa M30x1.5 z blokadą nastawy



dostępne w III kwartale 2024

indeks	Tmax	pakowanie	cena netto [zł]
<b>20-107-0300-003</b>	+50°C	1 100	<b>25,30</b>

**E** GRUPA RABATOWA

**GT03**

Głowica termostatyczna cieczowa M30x1.5 z blokadą nastawy



dostępne w III kwartale 2024

indeks	Tmax	pakowanie	cena netto [zł]
<b>20-107-0300-004</b>	+50°C	1 100	<b>25,30</b>

**E** GRUPA RABATOWA

**GT04****▶ NOWOŚĆ**

Głowica termostaticzna cieczowa M30x1.5 z blokadą nastawy



indeks	Tmax	pakowanie	cena netto [zł]
<b>20-107-0300-005</b>	+50°C	1 100	<b>25,30</b>

**(E)** GRUPA RABATOWA

dostępne w III kwartale 2024

**PHA-028**

Termostaticzny zawór grzejnikowy z nastawą wstępną, prosty

**PERFEKT<sup>2</sup>** SYSTEM

indeks	wielkość	PN	Tmax	pakowanie	cena netto [zł]
<b>20-028-0000-000</b>	½"	10	+120°C	10 100	<b>50,44</b>

**(K)** GRUPA RABATOWA**PHA-029**

Termostaticzny zawór grzejnikowy z nastawą wstępną, kątowy

**PERFEKT<sup>2</sup>** SYSTEM

indeks	wielkość	PN	Tmax	pakowanie	cena netto [zł]
<b>20-029-0000-000</b>	½"	10	+120°C	10 100	<b>47,25</b>

**(K)** GRUPA RABATOWA**PHA-030**

Zawór grzejnikowy prosty

**PERFEKT<sup>2</sup>** SYSTEM

indeks	wielkość	PN	Tmax	pakowanie	cena netto [zł]
<b>20-030-0000-300</b>	¾"	10	+120°C	10 100	<b>32,68</b>
<b>20-030-0000-000</b>	½"	10	+120°C	10 100	<b>32,68</b>

**(K)** GRUPA RABATOWA**PHA-031**

Zawór grzejnikowy odcinający prosty

**PERFEKT<sup>2</sup>** SYSTEM

indeks	wielkość	PN	Tmax	pakowanie	cena netto [zł]
<b>20-031-0001-300</b>	¾"	10	+120°C	10 100	<b>29,63</b>
<b>20-031-0001-000</b>	½"	10	+120°C	12 120	<b>29,63</b>

**(K)** GRUPA RABATOWA**PHA-032**

Zawór grzejnikowy kątowy

**PERFEKT<sup>2</sup>** SYSTEM

indeks	wielkość	PN	Tmax	pakowanie	cena netto [zł]
<b>20-032-0100-300</b>	¾"	10	+120°C	10 100	<b>32,68</b>
<b>20-032-0100-000</b>	½"	10	+120°C	10 100	<b>32,68</b>

**(K)** GRUPA RABATOWA**TRV02**

Zawór grzejnikowy odcinający prosty

**PERFEKT<sup>2</sup>** SYSTEM

indeks	wielkość	PN	Tmax	pakowanie	cena netto [zł]
<b>20-107-0300-001</b>	½"	10	+120°C	10 100	<b>25,38</b>

**(E)** GRUPA RABATOWA**TRV04**

Zawór grzejnikowy odcinający kątowy

**PERFEKT<sup>2</sup>** SYSTEM

indeks	wielkość	PN	Tmax	pakowanie	cena netto [zł]
<b>20-107-0300-002</b>	½"	10	+120°C	10 100	<b>23,86</b>

**(E)** GRUPA RABATOWA

**PHA-030A**

Zawór grzejnikowy z gwintem samouszczelniającym, prosty

**PERFEKT<sup>2</sup>SYSTEM**

indeks	wielkość	PN	Tmax	pakowanie		cena netto [zł]
<b>20-030-0000-100</b>	½"	10	+120°C	10	100	<b>33,02</b>

**(K)** GRUPA RABATOWA

**PHA-031A**

Zawór grzejnikowy odcinający z gwintem samouszczelniającym, prosty

**PERFEKT<sup>2</sup>SYSTEM**

indeks	wielkość	PN	Tmax	pakowanie		cena netto [zł]
<b>20-031-0001-100</b>	½"	10	+120°C	10	100	<b>30,33</b>

**(K)** GRUPA RABATOWA

**PHA-032A**

Zawór grzejnikowy z gwintem samouszczelniającym, kątowy

**PERFEKT<sup>2</sup>SYSTEM**

indeks	wielkość	PN	Tmax	pakowanie		cena netto [zł]
<b>20-032-0100-100</b>	½"	10	+120°C	10	100	<b>32,71</b>

**(K)** GRUPA RABATOWA

**PHA-033A**

Zawór grzejnikowy odcinający z gwintem samouszczelniającym, kątowy

**PERFEKT<sup>2</sup>SYSTEM**

indeks	wielkość	PN	Tmax	pakowanie		cena netto [zł]
<b>20-033-0101-100</b>	½"	10	+120°C	10	100	<b>29,97</b>

**(K)** GRUPA RABATOWA

**PHA-030/L**

Zawór grzejnikowy do wlotowania, prosty

**PERFEKT<sup>2</sup>SYSTEM**

indeks	wielkość	PN	Tmax	pakowanie		cena netto [zł]
<b>20-030-0000-200</b>	½" x 15	10	+120°C	10	100	<b>24,68</b>

**(K)** GRUPA RABATOWA

Produkt dostępny do wyczerpania zapasów

**PHA-033**

Zawór grzejnikowy odcinający kątowy

**PERFEKT<sup>2</sup>SYSTEM**

indeks	wielkość	PN	Tmax	pakowanie		cena netto [zł]
<b>20-033-0101-300</b>	¾"	10	+120°C	10	100	<b>29,63</b>
<b>20-033-0101-000</b>	½"	10	+120°C	12	120	<b>29,63</b>

**(K)** GRUPA RABATOWA

**PHA-032/L**

Zawór grzejnikowy do wlotowania, kątowy

**PERFEKT<sup>2</sup>SYSTEM**

indeks	wielkość	PN	Tmax	pakowanie		cena netto [zł]
<b>20-032-0100-200</b>	½" x 15	10	+120°C	10	100	<b>24,68</b>

**(K)** GRUPA RABATOWA

Produkt dostępny do wyczerpania zapasów





**PHA-033/L**

Zawór grzejnikowy odcinający do wlotowania, kątowy

PERFEKT<sup>SYSTEM</sup>

indeks	wielkość	PN	Tmax	pakowanie		cena netto [zł]
<b>20-033-0101-200</b>	½" x 15	10	+120°C	10	100	<b>21,08</b>

**(K)** GRUPA RABATOWA

Produkt dostępny do wyczerpania zapasów

**PHA-030/PEX**

Zawór grzejnikowy ze złączką do rury PEX lub PERT prosty

PERFEKT<sup>SYSTEM</sup>

indeks	wielkość	PN	Tmax	pakowanie		cena netto [zł]
<b>20-030-0000-003</b>	½"	10	+120°C	10	100	<b>28,46</b>

**(K)** GRUPA RABATOWA

**PHA-031/PEX**

Zawór grzejnikowy odcinający ze złączką do rury PEX lub PERT prosty

PERFEKT<sup>SYSTEM</sup>

indeks	wielkość	PN	Tmax	pakowanie		cena netto [zł]
<b>20-031-0001-003</b>	½"	10	+120°C	10	100	<b>24,92</b>

**(K)** GRUPA RABATOWA

**PHA-032/PEX**

Zawór grzejnikowy ze złączką do rury PEX lub PERT kątowy

PERFEKT<sup>SYSTEM</sup>

indeks	wielkość	PN	Tmax	pakowanie		cena netto [zł]
<b>20-032-0100-003</b>	½"	10	+120°C	10	100	<b>27,53</b>

**(K)** GRUPA RABATOWA

**PHA-033/PEX**

Zawór grzejnikowy odcinający ze złączką do rury PEX lub PERT kątowy

PERFEKT<sup>SYSTEM</sup>

indeks	wielkość	PN	Tmax	pakowanie		cena netto [zł]
<b>20-033-0101-003</b>	½"	10	+120°C	10	100	<b>24,92</b>

**(K)** GRUPA RABATOWA

**PHA-034**

Zawór grzejnikowy podwójny grzybkowy odcinający prosty z nyplami

PERFEKT<sup>SYSTEM</sup>

indeks	wielkość	PN	Tmax	pakowanie		cena netto [zł]
<b>20-034-0000-000</b>	½" x ¾"	10	+120°C	8	80	<b>65,16</b>

**(K)** GRUPA RABATOWA

**PHA-035**

Zawór grzejnikowy podwójny grzybkowy odcinający kątowy z nyplami

PERFEKT<sup>SYSTEM</sup>

indeks	wielkość	PN	Tmax	pakowanie		cena netto [zł]
<b>20-035-0000-000</b>	½" x ¾"	10	+120°C	8	80	<b>56,18</b>

**(K)** GRUPA RABATOWA

**PHA-035/1**

Zawór grzejnikowy podwójny  
grzybkowy odcinający  
kątowy bez nypli

PERFEKT<sup>2</sup> SYSTEM

indeks	wielkość	PN	Tmax	pakowanie		cena netto [zł]
<b>20-035-0000-001</b>	½" x ¾"	10	+120°C	8	80	<b>47,40</b>

**(K)** GRUPA RABATOWA

**7006+8021**

Zawór grzejnikowy podwójny  
kulowy odcinający prosty  
z nyplami



indeks	wielkość	PN	Tmax	pakowanie		cena netto [zł]
<b>20-104-0002-000</b>	½" x ¾"	10	+120°C	10	100	<b>63,54</b>

**(E)** GRUPA RABATOWA

**7005+8021**

Zawór grzejnikowy podwójny  
kulowy odcinający kątowy  
z nyplami



indeks	wielkość	PN	Tmax	pakowanie		cena netto [zł]
<b>20-104-0001-000</b>	½" x ¾"	10	+120°C	10	100	<b>60,64</b>

**(E)** GRUPA RABATOWA

**8021/S**

Nypl do zaworu  
grzejnikowego  
(PHA-034 i PHA-035)



indeks	wielkość	PN	Tmax	pakowanie		cena netto [zł]
<b>20-104-2001-000</b>	½" x ¾"	10	+120°C	10	700	<b>8,69</b>

**(K)** GRUPA RABATOWA

**8021**

Nypl do zaworu  
grzejnikowego kulowego  
podwójnego  
(a.7005 i a.7006)



indeks	wielkość	PN	Tmax	pakowanie		cena netto [zł]
<b>20-104-2000-000</b>	½" x ¾"	10	+110°C	10	1000	<b>8,44</b>

**(E)** GRUPA RABATOWA

**111-1(110/L)  
111-3(110/L)**

Zawór bezpieczeństwa  
z zaworem zwrotnym  
i spustem



indeks	DN	ciężnienie nastawne [bar]	Tmax	pakowanie		cena netto [zł]
<b>20-201-0150-000</b>	15	7	+100°C	1	150	<b>31,57</b>
<b>20-201-0200-000</b>	20	7	+100°C	1	125	<b>40,73</b>

**(C)** GRUPA RABATOWA

**7036B**

Zawór bezpieczeństwa  
z zaworem zwrotnym  
i spustem



indeks	DN	ciężnienie nastawne [bar]	Tmax	pakowanie		cena netto [zł]
<b>20-202-0150-000</b>	15	7	+95°C	20	200	<b>17,55</b>
<b>20-202-0200-000</b>	20	7	+95°C	10	100	<b>33,94</b>

**(E)** GRUPA RABATOWA

**PHA-402**

Pompa obiegowa PERFEKT do instalacji c.o. sterowana elektronicznie

PERFEKT<sup>SYSTEM</sup>

indeks	wielkość	wysokość podnoszenia (m)	pakowanie		cena netto [zł]
<b>31-402-0000-000</b>	180 mm	4	1	8	<b>632,18</b>

**P** GRUPA RABATOWA

**PHA-602**

Pompa obiegowa PERFEKT do instalacji c.o. sterowana elektronicznie

PERFEKT<sup>SYSTEM</sup>

indeks	wielkość	wysokość podnoszenia (m)	pakowanie		cena netto [zł]
<b>31-602-0000-000</b>	180 mm	6	1	8	<b>653,67</b>

**P** GRUPA RABATOWA

**PHA-602/P**

Pompa obiegowa PERFEKT do instalacji c.o. ogrzewania podłogowego sterowana elektronicznie

PERFEKT<sup>SYSTEM</sup>

indeks	wielkość	wysokość podnoszenia (m)	pakowanie		cena netto [zł]
<b>31-602-0001-000</b>	130 mm	6	1	8	<b>653,67</b>

**P** GRUPA RABATOWA

**CRS25/40**

Pompa obiegowa do wody pitnej

PERFEKT<sup>SYSTEM</sup>

indeks	wielkość	wysokość podnoszenia (m)	pakowanie		cena netto [zł]
<b>31-254-0000-000</b>	180 mm	4	1	8	<b>226,50</b>

**P** GRUPA RABATOWA

**CRS25/60**

Pompa obiegowa do wody pitnej

PERFEKT<sup>SYSTEM</sup>

indeks	wielkość	wysokość podnoszenia (m)	pakowanie		cena netto [zł]
<b>31-256-0000-000</b>	180 mm	6	1	8	<b>230,79</b>

**P** GRUPA RABATOWA

**PHA-100**Rozdzielacz mosiężny  
grzejnikowy prosty**(K1)** GRUPA RABATOWA**PERFEKT<sup>Q</sup>**  
SYSTEM

indeks	ilość obwodów	PN	Tmax	pakowanie		cena netto [zł]
<b>30-100-0202-000</b>	2	10	+95°C	1	1	<b>153,26</b>
<b>30-100-0302-000</b>	3	10	+95°C	1	1	<b>210,48</b>
<b>30-100-0402-000</b>	4	10	+95°C	1	1	<b>271,37</b>
<b>30-100-0502-000</b>	5	10	+95°C	1	1	<b>330,07</b>
<b>30-100-0602-000</b>	6	10	+95°C	1	1	<b>386,38</b>
<b>30-100-0702-000</b>	7	10	+95°C	1	1	<b>447,17</b>
<b>30-100-0802-000</b>	8	10	+95°C	1	1	<b>497,52</b>
<b>30-100-0902-000</b>	9	10	+95°C	1	1	<b>550,29</b>
<b>30-100-1002-000</b>	10	10	+95°C	1	1	<b>600,53</b>
<b>30-100-1102-000</b>	11	10	+95°C	1	1	<b>658,33</b>
<b>30-100-1202-000</b>	12	10	+95°C	1	1	<b>711,11</b>

**PHA-102**Rozdzielacz mosiężny  
grzejnikowy prosty  
z nyplami**(K1)** GRUPA RABATOWA**PERFEKT<sup>Q</sup>**  
SYSTEM

indeks	ilość obwodów	PN	Tmax	pakowanie		cena netto [zł]
<b>30-102-0202-000</b>	2	10	+95°C	1	1	<b>206,00</b>
<b>30-102-0302-000</b>	3	10	+95°C	1	1	<b>291,10</b>
<b>30-102-0402-000</b>	4	10	+95°C	1	1	<b>362,77</b>
<b>30-102-0502-000</b>	5	10	+95°C	1	1	<b>459,07</b>
<b>30-102-0602-000</b>	6	10	+95°C	1	1	<b>535,21</b>
<b>30-102-0702-000</b>	7	10	+95°C	1	1	<b>606,86</b>
<b>30-102-0802-000</b>	8	10	+95°C	1	1	<b>703,15</b>
<b>30-102-0902-000</b>	9	10	+95°C	1	1	<b>779,30</b>
<b>30-102-1002-000</b>	10	10	+95°C	1	1	<b>868,86</b>
<b>30-102-1102-000</b>	11	10	+95°C	1	1	<b>951,73</b>
<b>30-102-1202-000</b>	12	10	+95°C	1	1	<b>1034,97</b>

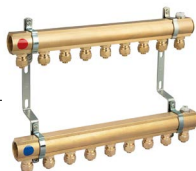
**PHA-102/Z**Rozdzielacz mosiężny  
ze złączkami do rur PEX**(K1)** GRUPA RABATOWA**PERFEKT<sup>Q</sup>**  
SYSTEM

indeks	ilość obwodów	PN	Tmax	pakowanie		cena netto [zł]
<b>30-102-0200-004</b>	2	10	+95°C	1	1	<b>234,26</b>
<b>30-102-0300-004</b>	3	10	+95°C	1	1	<b>332,76</b>
<b>30-102-0400-004</b>	4	10	+95°C	1	1	<b>417,28</b>
<b>30-102-0500-004</b>	5	10	+95°C	1	1	<b>527,42</b>
<b>30-102-0600-004</b>	6	10	+95°C	1	1	<b>616,63</b>
<b>30-102-0700-004</b>	7	10	+95°C	1	1	<b>701,16</b>
<b>30-102-0800-004</b>	8	10	+95°C	1	1	<b>811,29</b>
<b>30-102-0900-004</b>	9	10	+95°C	1	1	<b>900,48</b>
<b>30-102-1000-004</b>	10	10	+95°C	1	1	<b>1003,66</b>
<b>30-102-1100-004</b>	11	10	+95°C	1	1	<b>1099,81</b>
<b>30-102-1200-004</b>	12	10	+95°C	1	1	<b>1196,41</b>

**PHA-107**

Rozdzielacz mosiężny z rotametrem 0-5l do ogrzewania podłogowego



 GRUPA RABATOWA

Możliwość podłączenia zespołu mieszającego - rozstaw 210mm.



 **NOWOŚĆ**

**PERFEKT<sup>Q</sup>SYSTEM**

indeks	ilość obwodów	PN	Tmax	pakowanie		cena netto [zł]
						
<b>30-107-0200-000</b>	2	6	+70°C	1	1	<b>340,00</b>
<b>30-107-0300-000</b>	3	6	+70°C	1	1	<b>440,00</b>
<b>30-107-0400-000</b>	4	6	+70°C	1	1	<b>540,00</b>
<b>30-107-0500-000</b>	5	6	+70°C	1	1	<b>640,00</b>
<b>30-107-0600-000</b>	6	6	+70°C	1	1	<b>730,00</b>
<b>30-107-0700-000</b>	7	6	+70°C	1	1	<b>830,00</b>
<b>30-107-0800-000</b>	8	6	+70°C	1	1	<b>920,00</b>
<b>30-107-0900-000</b>	9	6	+70°C	1	1	<b>1020,00</b>
<b>30-107-1000-000</b>	10	6	+70°C	1	1	<b>1120,00</b>
<b>30-107-1100-000</b>	11	6	+70°C	1	1	<b>1220,00</b>
<b>30-107-1200-000</b>	12	6	+70°C	1	1	<b>1310,00</b>
<b>30-107-1300-000</b>	13	6	+70°C	1	1	<b>1480,00</b>
<b>30-107-1400-000</b>	14	6	+70°C	1	1	<b>1580,00</b>
<b>30-107-1500-000</b>	15	6	+70°C	1	1	<b>1680,00</b>
<b>30-107-1600-000</b>	16	6	+70°C	1	1	<b>1780,00</b>

**PHA-107/Z**

Rozdzielacz mosiężny z rotametrem 0-5l, ze złączkami do rur PEX - do ogrzewania podłogowego



 GRUPA RABATOWA

Możliwość podłączenia zespołu mieszającego - rozstaw 210mm.



 **NOWOŚĆ**

**PERFEKT<sup>Q</sup>SYSTEM**

indeks	ilość obwodów	PN	Tmax	pakowanie		cena netto [zł]
						
<b>30-107-0200-004</b>	2	6	+70°C	1	1	<b>388,00</b>
<b>30-107-0300-004</b>	3	6	+70°C	1	1	<b>512,00</b>
<b>30-107-0400-004</b>	4	6	+70°C	1	1	<b>636,00</b>
<b>30-107-0500-004</b>	5	6	+70°C	1	1	<b>760,00</b>
<b>30-107-0600-004</b>	6	6	+70°C	1	1	<b>874,00</b>
<b>30-107-0700-004</b>	7	6	+70°C	1	1	<b>998,00</b>
<b>30-107-0800-004</b>	8	6	+70°C	1	1	<b>1112,00</b>
<b>30-107-0900-004</b>	9	6	+70°C	1	1	<b>1236,00</b>
<b>30-107-1000-004</b>	10	6	+70°C	1	1	<b>1360,00</b>
<b>30-107-1100-004</b>	11	6	+70°C	1	1	<b>1484,00</b>
<b>30-107-1200-004</b>	12	6	+70°C	1	1	<b>1598,00</b>
<b>30-107-1300-004</b>	13	6	+70°C	1	1	<b>1792,00</b>
<b>30-107-1400-004</b>	14	6	+70°C	1	1	<b>1916,00</b>
<b>30-107-1500-004</b>	15	6	+70°C	1	1	<b>2040,00</b>
<b>30-107-1600-004</b>	16	6	+70°C	1	1	<b>2164,00</b>



**PHA-107/1/S**

Rozdzielacz mosiężny z rotametrem 0-5l do ogrzewania podłogowego

 GRUPA RABATOWA

Możliwość podłączenia zespołu mieszającego - rozstaw 210mm.

**PERFEKT<sup>Q</sup>SYSTEM**

indeks	ilość obwodów	PN	Tmax	pakowanie		cena netto [zł]
						
<b>30-107-0200-011</b>	2	6	+70°C	1	1	<b>310,00</b>
<b>30-107-0300-011</b>	3	6	+70°C	1	1	<b>410,00</b>
<b>30-107-0400-011</b>	4	6	+70°C	1	1	<b>510,00</b>
<b>30-107-0500-011</b>	5	6	+70°C	1	1	<b>610,00</b>
<b>30-107-0600-011</b>	6	6	+70°C	1	1	<b>700,00</b>
<b>30-107-0700-011</b>	7	6	+70°C	1	1	<b>800,00</b>
<b>30-107-0800-011</b>	8	6	+70°C	1	1	<b>890,00</b>
<b>30-107-0900-011</b>	9	6	+70°C	1	1	<b>990,00</b>
<b>30-107-1000-011</b>	10	6	+70°C	1	1	<b>1090,00</b>
<b>30-107-1100-011</b>	11	6	+70°C	1	1	<b>1190,00</b>
<b>30-107-1200-011</b>	12	6	+70°C	1	1	<b>1280,00</b>
<b>30-107-1300-011</b>	13	6	+70°C	1	1	<b>1420,00</b>
<b>30-107-1400-011</b>	14	6	+70°C	1	1	<b>1520,00</b>
<b>30-107-1500-011</b>	15	6	+70°C	1	1	<b>1620,00</b>
<b>30-107-1600-011</b>	16	6	+70°C	1	1	<b>1720,00</b>

**PHA-107/1/S/Z****NOWOŚĆ****PERFEKT<sup>2</sup>SYSTEM**

Rozdzielacz mosiężny  
ze złączkami do rur  
warstwowych



**K3** GRUPA RABATOWA

Możliwość podłączenia zespołu  
mieszającego - rozstaw 210mm.

indeks	ilość obwodów	PN	Tmax	pakowanie		cena netto [zł]
<b>30-107-0200-014</b>	2	6	+70°C	1	1	<b>358,00</b>
<b>30-107-0300-014</b>	3	6	+70°C	1	1	<b>482,00</b>
<b>30-107-0400-014</b>	4	6	+70°C	1	1	<b>606,00</b>
<b>30-107-0500-014</b>	5	6	+70°C	1	1	<b>730,00</b>
<b>30-107-0600-014</b>	6	6	+70°C	1	1	<b>844,00</b>
<b>30-107-0700-014</b>	7	6	+70°C	1	1	<b>968,00</b>
<b>30-107-0800-014</b>	8	6	+70°C	1	1	<b>1082,00</b>
<b>30-107-0900-014</b>	9	6	+70°C	1	1	<b>1206,00</b>
<b>30-107-1000-014</b>	10	6	+70°C	1	1	<b>1330,00</b>
<b>30-107-1100-014</b>	11	6	+70°C	1	1	<b>1454,00</b>
<b>30-107-1200-014</b>	12	6	+70°C	1	1	<b>1568,00</b>
<b>30-107-1300-014</b>	13	6	+70°C	1	1	<b>1732,00</b>
<b>30-107-1400-014</b>	14	6	+70°C	1	1	<b>1856,00</b>
<b>30-107-1500-014</b>	15	6	+70°C	1	1	<b>1980,00</b>
<b>30-107-1600-014</b>	16	6	+70°C	1	1	<b>2104,00</b>

**PHA-109**

Rozdzielacz mosiężny  
z wkładkami zaworowymi  
odcinającymi

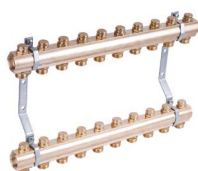

**K2** GRUPA RABATOWA

**PERFEKT<sup>2</sup>SYSTEM**

indeks	ilość obwodów	PN	Tmax	pakowanie		cena netto [zł]
<b>30-109-0200-000</b>	2	10	+95°C	1	1	<b>224,08</b>
<b>30-109-0300-000</b>	3	10	+95°C	1	1	<b>311,21</b>
<b>30-109-0400-000</b>	4	10	+95°C	1	1	<b>404,58</b>
<b>30-109-0500-000</b>	5	10	+95°C	1	1	<b>506,27</b>
<b>30-109-0600-000</b>	6	10	+95°C	1	1	<b>587,16</b>
<b>30-109-0700-000</b>	7	10	+95°C	1	1	<b>676,40</b>
<b>30-109-0800-000</b>	8	10	+95°C	1	1	<b>746,94</b>
<b>30-109-0900-000</b>	9	10	+95°C	1	1	<b>840,29</b>
<b>30-109-1000-000</b>	10	10	+95°C	1	1	<b>910,85</b>
<b>30-109-1100-000</b>	11	10	+95°C	1	1	<b>995,92</b>
<b>30-109-1200-000</b>	12	10	+95°C	1	1	<b>1089,28</b>

**PHA-109A**

Rozdzielacz mosiężny  
- komplet

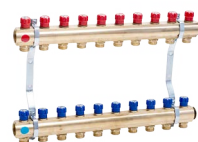

**K2** GRUPA RABATOWA

**PERFEKT<sup>2</sup>SYSTEM**

indeks	ilość obwodów	PN	Tmax	pakowanie		cena netto [zł]
<b>30-109-0200-002</b>	2	10	+95°C	1	1	<b>232,55</b>
<b>30-109-0300-002</b>	3	10	+95°C	1	1	<b>322,97</b>
<b>30-109-0400-002</b>	4	10	+95°C	1	1	<b>419,86</b>
<b>30-109-0500-002</b>	5	10	+95°C	1	1	<b>525,35</b>
<b>30-109-0600-002</b>	6	10	+95°C	1	1	<b>609,33</b>
<b>30-109-0700-002</b>	7	10	+95°C	1	1	<b>701,92</b>
<b>30-109-0800-002</b>	8	10	+95°C	1	1	<b>775,12</b>
<b>30-109-0900-002</b>	9	10	+95°C	1	1	<b>872,00</b>
<b>30-109-1000-002</b>	10	10	+95°C	1	1	<b>945,57</b>
<b>30-109-1100-002</b>	11	10	+95°C	1	1	<b>1033,36</b>
<b>30-109-1200-002</b>	12	10	+95°C	1	1	<b>1130,38</b>

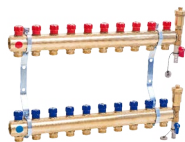
**PHA-109A/1**Rozdzielacz mosiężny  
- komplet**K2** GRUPA RABATOWA**PERFEKT<sup>2</sup>** SYSTEM

indeks	ilość obwodów	PN	Tmax	pakowanie	cena netto [zł]
<b>30-109-0200-001</b>	2	10	+95°C	1 1	<b>340,26</b>
<b>30-109-0300-001</b>	3	10	+95°C	1 1	<b>428,46</b>
<b>30-109-0400-001</b>	4	10	+95°C	1 1	<b>516,67</b>
<b>30-109-0500-001</b>	5	10	+95°C	1 1	<b>608,46</b>
<b>30-109-0600-001</b>	6	10	+95°C	1 1	<b>693,10</b>
<b>30-109-0700-001</b>	7	10	+95°C	1 1	<b>777,71</b>
<b>30-109-0800-001</b>	8	10	+95°C	1 1	<b>864,13</b>
<b>30-109-0900-001</b>	9	10	+95°C	1 1	<b>955,93</b>
<b>30-109-1000-001</b>	10	10	+95°C	1 1	<b>1040,55</b>
<b>30-109-1100-001</b>	11	10	+95°C	1 1	<b>1128,77</b>
<b>30-109-1200-001</b>	12	10	+95°C	1 1	<b>1216,98</b>

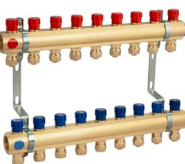
**PHA-109A/Z**Rozdzielacz mosiężny  
z wkładkami zaworowymi  
odcinającymi ze złączkami  
do rur PEX - komplet**K2** GRUPA RABATOWA**PERFEKT<sup>2</sup>** SYSTEM

indeks	ilość obwodów	PN	Tmax	pakowanie	cena netto [zł]
<b>30-109-0200-004</b>	2	10	+95°C	1 1	<b>230,49</b>
<b>30-109-0300-004</b>	3	10	+95°C	1 1	<b>350,70</b>
<b>30-109-0400-004</b>	4	10	+95°C	1 1	<b>456,87</b>
<b>30-109-0500-004</b>	5	10	+95°C	1 1	<b>571,61</b>
<b>30-109-0600-004</b>	6	10	+95°C	1 1	<b>664,82</b>
<b>30-109-0700-004</b>	7	10	+95°C	1 1	<b>766,66</b>
<b>30-109-0800-004</b>	8	10	+95°C	1 1	<b>849,10</b>
<b>30-109-0900-004</b>	9	10	+95°C	1 1	<b>955,24</b>
<b>30-109-1000-004</b>	10	10	+95°C	1 1	<b>1038,04</b>
<b>30-109-1100-004</b>	11	10	+95°C	1 1	<b>1135,08</b>
<b>30-109-1200-004</b>	12	10	+95°C	1 1	<b>1241,36</b>

**PHA-120**Rozdzielacz ze stali  
nierdzewnej**K1** GRUPA RABATOWA**PERFEKT<sup>2</sup>** SYSTEM

indeks	ilość obwodów	PN	Tmax	pakowanie	cena netto [zł]
<b>30-120-0200-001</b>	2	10	+95°C	1 1	<b>138,28</b>
<b>30-120-0300-001</b>	3	10	+95°C	1 1	<b>191,07</b>
<b>30-120-0400-001</b>	4	10	+95°C	1 1	<b>235,14</b>
<b>30-120-0500-001</b>	5	10	+95°C	1 1	<b>279,25</b>
<b>30-120-0600-001</b>	6	10	+95°C	1 1	<b>320,39</b>
<b>30-120-0700-001</b>	7	10	+95°C	1 1	<b>363,02</b>
<b>30-120-0800-001</b>	8	10	+95°C	1 1	<b>404,16</b>
<b>30-120-0900-001</b>	9	10	+95°C	1 1	<b>442,40</b>
<b>30-120-1000-001</b>	10	10	+95°C	1 1	<b>479,14</b>
<b>30-120-1100-001</b>	11	10	+95°C	1 1	<b>529,11</b>
<b>30-120-1200-001</b>	12	10	+95°C	1 1	<b>571,72</b>

**PHA-122**Rozdzielacz ze stali  
nierdzewnej z nypłami**K1** GRUPA RABATOWA**PERFEKT<sup>2</sup>** SYSTEM

indeks	ilość obwodów	PN	Tmax	pakowanie	cena netto [zł]
<b>30-122-0200-001</b>	2	10	+95°C	1 1	<b>177,11</b>
<b>30-122-0300-001</b>	3	10	+95°C	1 1	<b>242,19</b>
<b>30-122-0400-001</b>	4	10	+95°C	1 1	<b>302,77</b>
<b>30-122-0500-001</b>	5	10	+95°C	1 1	<b>363,32</b>
<b>30-122-0600-001</b>	6	10	+95°C	1 1	<b>420,83</b>
<b>30-122-0700-001</b>	7	10	+95°C	1 1	<b>479,89</b>
<b>30-122-0800-001</b>	8	10	+95°C	1 1	<b>537,40</b>
<b>30-122-0900-001</b>	9	10	+95°C	1 1	<b>591,88</b>
<b>30-122-1000-001</b>	10	10	+95°C	1 1	<b>644,88</b>
<b>30-122-1100-001</b>	11	10	+95°C	1 1	<b>711,49</b>
<b>30-122-1200-001</b>	12	10	+95°C	1 1	<b>770,52</b>

## PHA-127

Rozdzielacz ze stali nierdzewnej z rotametrem 0-5l do ogrzewania podłogowego



 GRUPA RABATOWA



Możliwość podłączenia zespołu mieszającego - rozstaw 210mm.

 **NOWOŚĆ**

PERFEKT<sup>2</sup>SYSTEM

indeks	ilość obwodów	PN	Tmax	pakowanie		cena netto [zł]
						
30-127-0200-001	2	6	+70°C	1	1	378,00
30-127-0300-001	3	6	+70°C	1	1	473,00
30-127-0400-001	4	6	+70°C	1	1	574,00
30-127-0500-001	5	6	+70°C	1	1	670,00
30-127-0600-001	6	6	+70°C	1	1	770,00
30-127-0700-001	7	6	+70°C	1	1	868,00
30-127-0800-001	8	6	+70°C	1	1	963,00
30-127-0900-001	9	6	+70°C	1	1	1062,00
30-127-1000-001	10	6	+70°C	1	1	1160,00
30-127-1100-001	11	6	+70°C	1	1	1244,00
30-127-1200-001	12	6	+70°C	1	1	1347,00
30-127-1300-001	13	6	+70°C	1	1	1469,00
30-127-1400-001	14	6	+70°C	1	1	1571,00
30-127-1500-001	15	6	+70°C	1	1	1671,00
30-127-1600-001	16	6	+70°C	1	1	1775,00

## PHA-127/Z

Rozdzielacz ze stali nierdzewnej ze złączkami do rur wielowarstwowych



 GRUPA RABATOWA



Możliwość podłączenia zespołu mieszającego - rozstaw 210mm.

 **NOWOŚĆ**

PERFEKT<sup>2</sup>SYSTEM

indeks	ilość obwodów	PN	Tmax	pakowanie		cena netto [zł]
						
30-127-0200-004	2	6	+70°C	1	1	426,00
30-127-0300-004	3	6	+70°C	1	1	545,00
30-127-0400-004	4	6	+70°C	1	1	670,00
30-127-0500-004	5	6	+70°C	1	1	790,00
30-127-0600-004	6	6	+70°C	1	1	914,00
30-127-0700-004	7	6	+70°C	1	1	1036,00
30-127-0800-004	8	6	+70°C	1	1	1155,00
30-127-0900-004	9	6	+70°C	1	1	1278,00
30-127-1000-004	10	6	+70°C	1	1	1400,00
30-127-1100-004	11	6	+70°C	1	1	1508,00
30-127-1200-004	12	6	+70°C	1	1	1635,00
30-127-1300-004	13	6	+70°C	1	1	1781,00
30-127-1400-004	14	6	+70°C	1	1	1907,00
30-127-1500-004	15	6	+70°C	1	1	2031,00
30-127-1600-004	16	6	+70°C	1	1	2159,00

## PHA-127/1/S

Rozdzielacz ze stali nierdzewnej z rotametrem 0-5l do ogrzewania podłogowego



 GRUPA RABATOWA



Możliwość podłączenia zespołu mieszającego - rozstaw 210mm.

 **NOWOŚĆ**

PERFEKT<sup>2</sup>SYSTEM

indeks	ilość obwodów	PN	Tmax	pakowanie		cena netto [zł]
						
30-127-0200-011	2	6	+70°C	1	1	348,00
30-127-0300-011	3	6	+70°C	1	1	443,00
30-127-0400-011	4	6	+70°C	1	1	544,00
30-127-0500-011	5	6	+70°C	1	1	640,00
30-127-0600-011	6	6	+70°C	1	1	740,00
30-127-0700-011	7	6	+70°C	1	1	838,00
30-127-0800-011	8	6	+70°C	1	1	933,00
30-127-0900-011	9	6	+70°C	1	1	1032,00
30-127-1000-011	10	6	+70°C	1	1	1130,00
30-127-1100-011	11	6	+70°C	1	1	1214,00
30-127-1200-011	12	6	+70°C	1	1	1317,00
30-127-1300-011	13	6	+70°C	1	1	1439,00
30-127-1400-011	14	6	+70°C	1	1	1541,00
30-127-1500-011	15	6	+70°C	1	1	1641,00
30-127-1600-011	16	6	+70°C	1	1	1745,00



**PHA-127/1/S/Z****NOWOŚĆ****PERFEKT<sup>2</sup>SYSTEM**

Rozdzielacz ze stali nierdzewnej  
ze złączkami do rur  
wielowarstwowych



**K3** GRUPA RABATOWA

Możliwość podłączenia zespołu  
mieszającego - rozstaw 210mm.

indeks	ilość obwodów	PN	Tmax	pakowanie		cena netto [zł]
<b>30-127-0200-014</b>	2	6	+70°C	1	1	<b>396,00</b>
<b>30-127-0300-014</b>	3	6	+70°C	1	1	<b>515,00</b>
<b>30-127-0400-014</b>	4	6	+70°C	1	1	<b>640,00</b>
<b>30-127-0500-014</b>	5	6	+70°C	1	1	<b>760,00</b>
<b>30-127-0600-014</b>	6	6	+70°C	1	1	<b>884,00</b>
<b>30-127-0700-014</b>	7	6	+70°C	1	1	<b>1006,00</b>
<b>30-127-0800-014</b>	8	6	+70°C	1	1	<b>1125,00</b>
<b>30-127-0900-014</b>	9	6	+70°C	1	1	<b>1248,00</b>
<b>30-127-1000-014</b>	10	6	+70°C	1	1	<b>1370,00</b>
<b>30-127-1100-014</b>	11	6	+70°C	1	1	<b>1478,00</b>
<b>30-127-1200-014</b>	12	6	+70°C	1	1	<b>1605,00</b>
<b>30-127-1300-014</b>	13	6	+70°C	1	1	<b>1751,00</b>
<b>30-127-1400-014</b>	14	6	+70°C	1	1	<b>1877,00</b>
<b>30-127-1500-014</b>	15	6	+70°C	1	1	<b>2001,00</b>
<b>30-127-1600-014</b>	16	6	+70°C	1	1	<b>2129,00</b>

**PHA-129A/1****PERFEKT<sup>2</sup>SYSTEM**

Rozdzielacz ze stali  
nierdzewnej - komplet



**K2** GRUPA RABATOWA

indeks	ilość obwodów	PN	Tmax	pakowanie		cena netto [zł]
<b>30-129-0200-001</b>	2	10	+95°C	1	1	<b>360,98</b>
<b>30-129-0300-001</b>	3	10	+95°C	1	1	<b>461,73</b>
<b>30-129-0400-001</b>	4	10	+95°C	1	1	<b>554,07</b>
<b>30-129-0500-001</b>	5	10	+95°C	1	1	<b>654,82</b>
<b>30-129-0600-001</b>	6	10	+95°C	1	1	<b>738,75</b>
<b>30-129-0700-001</b>	7	10	+95°C	1	1	<b>822,71</b>
<b>30-129-0800-001</b>	8	10	+95°C	1	1	<b>898,28</b>
<b>30-129-0900-001</b>	9	10	+95°C	1	1	<b>990,61</b>
<b>30-129-1000-001</b>	10	10	+95°C	1	1	<b>1082,96</b>
<b>30-129-1100-001</b>	11	10	+95°C	1	1	<b>1175,30</b>
<b>30-129-1200-001</b>	12	10	+95°C	1	1	<b>1259,28</b>

**PHA-131**

Zespół mieszający do ogrzewania podłogowego z pompą Grundfos i zaworem trójdrożnym termost. temp. 20-43°C kv2.5



**K2** GRUPA RABATOWA

**PERFEKT<sup>2</sup>SYSTEM**

indeks	PN	Tmax	pakowanie	cena netto [zł]
<b>30-600-0000-003</b>	10	+75°C	1 4	<b>2317,79</b>

**PHA-131/1**

Zespół mieszający do ogrzewania podłogowego z pompą Grundfos i z-rem trójdrożnym termost.temp.20-43°C, kv 2,5 i uchwytem 555/1



**K2** GRUPA RABATOWA

**PERFEKT<sup>2</sup>SYSTEM**

indeks	PN	Tmax	pakowanie	cena netto [zł]
<b>30-600-0000-006</b>	10	+75°C	1 8	<b>2350,80</b>

**PHA-132**

**NOWOŚĆ**

Trójdrożny termostatyczny zawór mieszający



**K** GRUPA RABATOWA

**PERFEKT<sup>2</sup>SYSTEM**

indeks	wielkość	PN	Tmax	pakowanie	cena netto [zł]
<b>30-601-0250-000</b>	1"	10	+70°C	1 40	<b>185,00</b>

**PHA-061M**

Separator magnetyczny



**K** GRUPA RABATOWA

**PERFEKT<sup>2</sup>SYSTEM**

indeks	wielkość	Magnes neodymowy	Tmax	pakowanie	cena netto [zł]
<b>03-061-0200-000</b>	¾"	9000 Gs	+90°C	1 10	<b>240,00</b>

**PHA-063M**

Separator magnetyczny



**K** GRUPA RABATOWA

**PERFEKT<sup>2</sup>SYSTEM**

indeks	wielkość	Magnes neodymowy	Tmax	pakowanie	cena netto [zł]
<b>03-063-0250-000</b>	1"	12000 Gs	+90°C	1 6	<b>510,00</b>
<b>03-063-0320-000</b>	1¼"	12000 Gs	+90°C	1 6	<b>600,00</b>

**PHA-064M**

**NOWOŚĆ**

Separator magnetyczny MAX FLOW z filtrem i odpowietrznikiem



**K** GRUPA RABATOWA

**PERFEKT<sup>2</sup>SYSTEM**

indeks	wielkość	Przepływ Qm³/h	Magnes neodymowy	Tmax	pakowanie	cena netto [zł]
<b>03-064-0250-000</b>	1"	4,37	9000 Gs	+90°C	1 6	<b>535,00</b>
<b>03-064-0320-000</b>	1¼"	4,95	9000 Gs	+90°C	1 6	<b>635,00</b>

**PHA-090**

Zacisk do rur PEX lub PERT

**PERFEKT<sup>2</sup>**<sub>SYSTEM</sub>

indeks	wielkość	PN	Tmax	pakowanie	cena netto [zł]
<b>20-090-0000-000</b>	16 x 2	10	+90°C	10 280	<b>8,00</b>

**(K)** GRUPA RABATOWA**PHA-090/1**

Zacisk do rur wielowarstwowych

**PERFEKT<sup>2</sup>**<sub>SYSTEM</sub>

indeks	wielkość	PN	Tmax	pakowanie	cena netto [zł]
<b>20-090-0160-001</b>	16 x 2 (¾")	10	+90°C	10 280	<b>7,50</b>
<b>20-090-0170-001</b>	17x 2 (¾")	10	+90°C	10 280	<b>8,65</b>
<b>20-090-0180-001</b>	18x 2 (¾")	10	+90°C	10 280	<b>8,85</b>
<b>20-090-0200-001</b>	20x 2 (¾")	10	+90°C	10 280	<b>10,62</b>

**(K)** GRUPA RABATOWA**215E**

Zacisk do rur miedzianych

**PERFEKT<sup>2</sup>**<sub>SYSTEM</sub>

indeks	wielkość	PN	Tmax	pakowanie	cena netto [zł]
<b>20-104-9001-000</b>	ø15	10	+100°C	30 240	<b>10,57</b>

**(E)** GRUPA RABATOWA**PHA-098**

Zespół odpowietrzająco spustowy do rozdzielacza

**PERFEKT<sup>2</sup>**<sub>SYSTEM</sub>

indeks	kolor	PN	Tmax	pakowanie	cena netto [zł]
<b>30-200-0980-000</b>	czerwony	10	+120°C	10 40	<b>68,69</b>
<b>30-200-0980-010</b>	niebieski	10	+120°C	10 40	<b>68,69</b>

**(K)** GRUPA RABATOWA**SS555/1**

Uchwyt do rozdzielacza ze stali nierdzewnej



indeks	rozstaw [mm]	pakowanie	cena netto [zł]
<b>30-200-5551-200</b>	210	1 60	<b>25,09</b>

**(D)** GRUPA RABATOWA**555/1**

Uchwyt do rozdzielaczy mosiężnych serii PHA-107



<b>30-200-5551-000</b>	210	1 60	<b>15,61</b>
------------------------	-----	------	--------------

**(D)** GRUPA RABATOWA**748U**

Nypel do belki rozdzielacza mosiężnego uniwersalny



indeks	wielkość	PN	Tmax	pakowanie	cena netto [zł]
<b>30-200-7480-002</b>	½" x ¾"	10	+95°C	125 500	<b>9,66</b>

**(K2)** GRUPA RABATOWA**749**

Korek do belki rozdzielacza mosiężnego



indeks	PN	Tmax	pakowanie	cena netto [zł]
<b>30-200-7490-000</b>	10	+95°C	100 400	<b>10,15</b>

**(D)** GRUPA RABATOWA

762

Złączka wkrętna-nypel z wymowaną końcówką do wkładek zaworowych do rozdzielaczy



indeks	PN	Tmax	pakowanie		cena netto [zł]
<b>30-200-7550-020</b>	10	+95°C	10	200	<b>16,27</b>

**D** GRUPA RABATOWA

763

Złączka wkrętna-nypel z wymowaną końcówką do wkładek zaworowych do rozdzielaczy



indeks	PN	Tmax	pakowanie		cena netto [zł]
<b>30-200-7550-021</b>	10	+95°C	100	400	<b>8,50</b>

**D** GRUPA RABATOWA

750

Wkładka zaworowa regulacyjna do belki rozdzielacza mosiężnego



indeks	PN	Tmax	pakowanie		cena netto [zł]
<b>30-200-7500-000</b>	10	+95°C	10	100	<b>42,21</b>

**D** GRUPA RABATOWA

751

Wkładka zaworowa odcinająca do belki rozdzielacza mosiężnego



indeks	PN	Tmax	pakowanie		cena netto [zł]
<b>30-200-7510-000</b>	10	+95°C	1	10	<b>34,47</b>

**D** GRUPA RABATOWA

**747**Trójnik do belki  
rozdzielacza mosiężnego

indeks	wielkość	pakowanie		cena netto [zł]
<b>30-200-7470-000</b>	½" x 1" x ½"	10	200	<b>20,83</b>

**D** GRUPA RABATOWA**9003+S**Odpowietrznik  
automatyczny z zaworem  
stopowym, mosiężny

indeks	wielkość	PN	Tmax	pakowanie		cena netto [zł]
<b>20-400-0003-000</b>	½"	10	+110°C	1	100	<b>27,58</b>

**B** GRUPA RABATOWA**9003C+S**Odpowietrznik  
automatyczny z zaworem  
stopowym, chromowany

indeks	wielkość	PN	Tmax	pakowanie		cena netto [zł]
<b>20-400-0003-001</b>	½"	10	+110°C	1	100	<b>28,43</b>

**B** GRUPA RABATOWA**418**

Odpowietrznik ręczny



indeks	wielkość	PN	Tmax	pakowanie		cena netto [zł]
<b>20-401-0150-001</b>	½"	10	+120°C	100	500	<b>6,55</b>

**E** GRUPA RABATOWA**417**Odpowietrznik ręczny  
o-ring

indeks	wielkość	PN	Tmax	pakowanie		cena netto [zł]
<b>20-401-0150-000</b>	½"	10	+120°C	10	600	<b>4,26</b>

**E** GRUPA RABATOWA**4220**Kluczyk do odpowietrznika  
ręcznego o-ring

indeks	pakowanie		cena netto [zł]
<b>20-402-0001-000</b>	500	2500	<b>1,46</b>

**E** GRUPA RABATOWA**4216**

Korek zaślepiający o-ring



indeks	wielkość	PN	Tmax	pakowanie		cena netto [zł]
<b>20-402-0000-000</b>	½"	10	+120°C	100	1000	<b>3,15</b>

**E** GRUPA RABATOWA

**TS+5.11/230**

Siłownik termiczny  
beźprądowo zamknięty  
M30x1,5

PERFEKT<sup>2</sup> SYSTEM

indeks	wielkość	pakowanie		cena netto [zł]
<b>32-000-0000-000</b>	M30x1,5	1	40	<b>112,64</b>

**K2** GRUPA RABATOWA

**E200**

Regulator temperatury  
cyfrowy tygodniowy

PERFEKT<sup>2</sup> SYSTEM

indeks	pakowanie		cena netto [zł]
<b>32-000-1000-000</b>	1	48	<b>332,38</b>

**K2** GRUPA RABATOWA

**RTR3520**

Termostat pokojowy

PERFEKT<sup>2</sup> SYSTEM

indeks	pakowanie		cena netto [zł]
<b>32-000-3000-000</b>	1	25	<b>64,75</b>

**K2** GRUPA RABATOWA

**INSTAT868A1A**

Odbiornik radiowy  
do siłowników i pomp

PERFEKT<sup>2</sup> SYSTEM

indeks	pakowanie		cena netto [zł]
<b>32-000-0001-000</b>	1	1	<b>304,11</b>

**K2** GRUPA RABATOWA

**B-002**

Komplet uchwyty  
do bojlera



indeks	pakowanie		cena netto [zł]
<b>20-900-0001-000</b>	1	5	<b>69,61</b>

**E** GRUPA RABATOWA

**B-003**

Komplet uchwyty  
do zbiornika  
wyrównawczego



indeks	pakowanie		cena netto [zł]
<b>20-900-0002-000</b>	1	5	<b>50,60</b>

**E** GRUPA RABATOWA



Pełny kompletny system  
- gwarancja jakości  
i zadowolenia

# PERFEXIM

CENNIK ARMATURA 2024



## PERFEKT<sup>?</sup>SYSTEM<sup>+</sup>

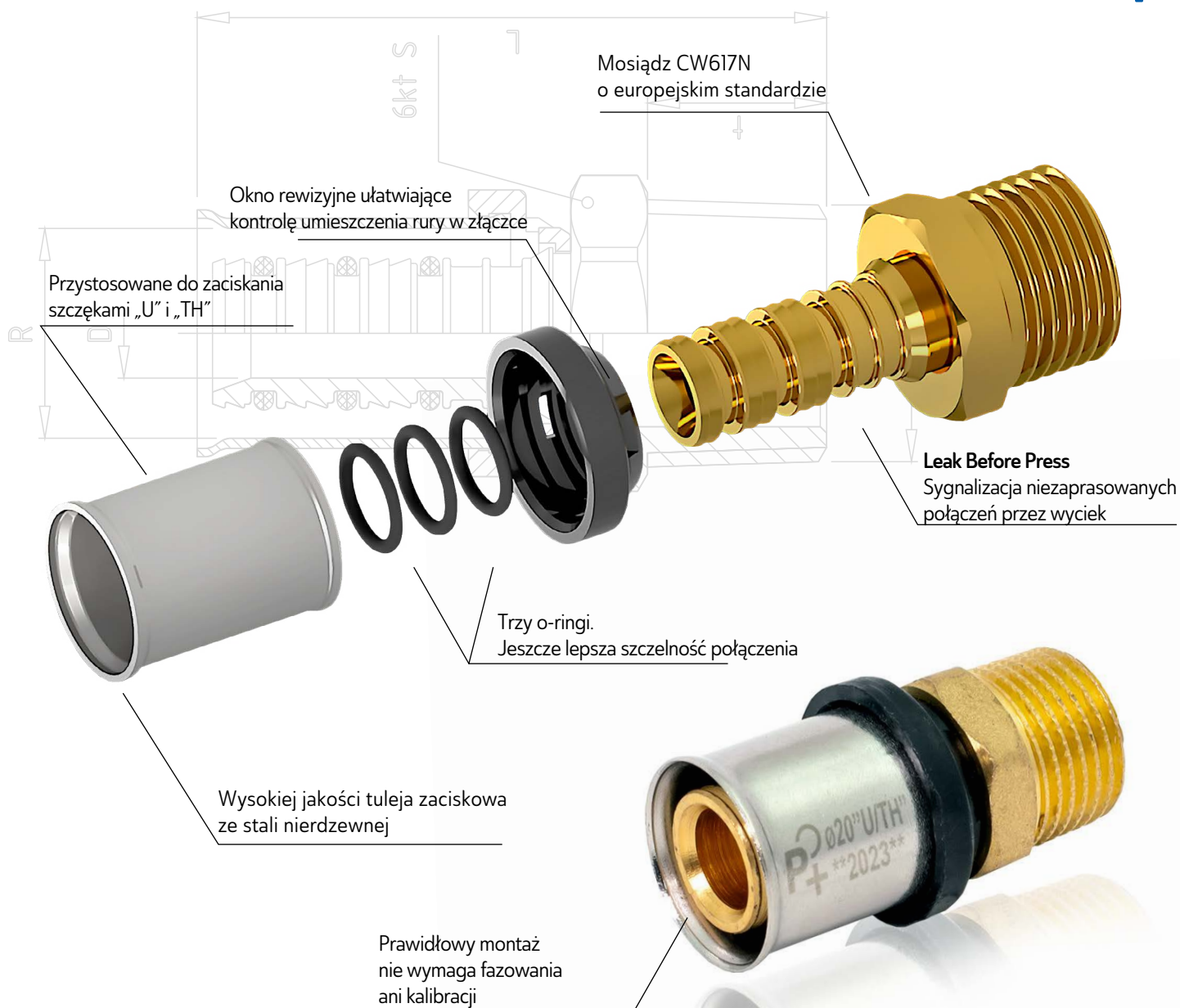

## SYSTEMY RUROWE WIELOWARSTWOWE 55-67

Rury PERT		56
Rury PEX		56
Złączki zaprasowywane	PERFEKT <sup>?</sup> SYSTEM <sup>+</sup>	57
Złączki zaprasowywane	PERFEKT <sup>?</sup> SYSTEM	60
Złączki skręcane		63
System montażowy		66
Narzędzia		67

## PARAMETRY

Parametry pracy rur wielowarstwowych PERT/AL/PERT, PEX/AL/PE oraz złączek skręcanych i zaprasowywanych są determinowane normą EN21003, która obecnie obowiązuje w Polsce.

Klasa	Pmax	Tmax
1	1,0 MPa	+60°C
5	0,6 MPa	+90°C

Parametry pracy rur wielowarstwowych PERT/EVOH/PERT

Klasa	Pmax	Tmax
4	1,0 MPa	+70°C

## 700EV

 **NOWOŚĆ**
PERFEKT<sup>2</sup> SYSTEM

**PERFEKT SYSTEM**  
Rura pert/evoh/pert



indeks	wielkość	pakowanie [mb]		cena netto [zł]
		krag	paleta	
<b>60-300-1600-600</b>	16 x 2,0	600	2400	<b>3,70</b>
<b>60-300-1720-500</b>	17 x 2,0	500		<b>3,70</b>
<b>60-300-1820-600</b>	18 x 2,0			



GRUPA RABATOWA

dostępne w II kwartale 2024  
dostępne w III kwartale 2024

## 700PER

PERFEKT<sup>2</sup> SYSTEM

**PERFEKT SYSTEM**  
Rura pert/al./pert



indeks	wielkość	pakowanie [mb]		cena netto [zł]
		krag	paleta	
<b>60-200-1620-200</b>	16 x 2,0	200	4000	<b>5,35</b>
<b>60-200-1620-500</b>	16 x 2,0	500	4000	<b>5,35</b>
<b>60-200-1820-200</b>	18 x 2,0	200		
<b>60-200-2000-100</b>	20 x 2,0	100	2000	<b>7,59</b>
<b>60-200-2500-050</b>	25 x 2,5	50	1000	<b>12,81</b>
<b>60-200-3200-025</b>	32 x 3,0	25	600	<b>21,53</b>
<b>60-200-4040-005</b>	40 x 4,0	5	25	<b>58,33</b>
<b>60-200-5045-005</b>	50 x 4,5	5	15	<b>87,50</b>
<b>60-200-6360-005</b>	63 x 6,0	5	15	<b>141,67</b>



GRUPA RABATOWA

## 700PER-IZO

PERFEKT<sup>2</sup> SYSTEM

**PERFEKT SYSTEM**  
Rura pert/al./pert w otulinie polietylenowej



indeks	wielkość	otulina [mm]	kolor otuliny	pakowanie [mb]		cena netto [zł]
				krag	paleta	
<b>60-200-1623-100</b>	16 x 2,0	9	niebieska	100	1400	<b>7,37</b>
<b>60-200-1624-100</b>	16 x 2,0	9	czerwona	100	1400	<b>7,37</b>
<b>60-200-2001-050</b>	20 x 2,0	9	niebieska	50	750	<b>10,61</b>
<b>60-200-2002-050</b>	20 x 2,0	9	czerwona	50	750	<b>10,61</b>
<b>60-200-2501-025</b>	25 x 2,5	9	niebieska	25	450	<b>16,87</b>
<b>60-200-2502-025</b>	25 x 2,5	9	czerwona	25	450	<b>16,87</b>
<b>60-200-3201-025</b>	32 x 3,0	9	niebieska	25	450	<b>27,16</b>
<b>60-200-3202-025</b>	32 x 3,0	9	czerwona	25	450	<b>27,16</b>



GRUPA RABATOWA

## 700PE

PERFEKT<sup>2</sup> SYSTEM

**PERFEKT SYSTEM**  
Rura pex/al./pe



indeks	wielkość	pakowanie [mb]		cena netto [zł]
		krag	paleta	
<b>60-100-1610-100</b>	16 x 2,0	100	4000	<b>5,35</b>
<b>60-100-1620-200</b>	16 x 2,0	200	4000	<b>5,35</b>
<b>60-100-1620-500</b>	16 x 2,0	500	4000	<b>5,35</b>
<b>60-100-2000-100</b>	20 x 2,0	100	1800	<b>6,89</b>
<b>60-100-2500-050</b>	25 x 2,5	50	1000	<b>11,06</b>
<b>60-100-3200-025</b>	32 x 3,0	25	600	<b>17,95</b>



GRUPA RABATOWA

700PE  
w odcinkach 5mPERFEKT<sup>2</sup> SYSTEM

**PERFEKT SYSTEM**  
Rura pex/al./pe



indeks	wielkość	pakowanie [mb]		cena netto [zł]
		odcinki	paleta	
<b>60-100-1620-005</b>	16 x 2,0	5	300	<b>5,35</b>
<b>60-100-2000-005</b>	20 x 2,0	5	225	<b>6,94</b>
<b>60-100-2500-005</b>	25 x 2,5	5	125	<b>11,39</b>
<b>60-100-3200-005</b>	32 x 3,0	5	75	<b>17,95</b>



GRUPA RABATOWA



## 901

**PERFEKT SYSTEM PLUS**  
Nypel zaprasowywany GZ

**G** GRUPA RABATOWA

\*) dostępny w III kwartale 2024

PERFEKT<sub>SYSTEM</sub>

indeks	wielkość	PN	Tmax	pakowanie		cena netto [zł]
<b>62-901-1615-000</b>	16 x 1/2"	10	+90°C	5	280	<b>17,36</b>
<b>62-901-1620-000</b>	16 x 3/4"	10	+90°C	5	200	<b>22,40</b>
<b>62-901-1815-000</b>	18 x 1/2"	10	+90°C	5	200	<b>19,60</b>
<b>62-901-1820-000</b>	18 x 3/4"	10	+90°C	5	200	<b>23,90</b>
<b>62-901-2015-000</b>	20 x 1/2"	10	+90°C	5	200	<b>24,89</b>
<b>62-901-2020-000</b>	20 x 3/4"	10	+90°C	5	200	<b>22,95</b>
<b>62-901-2025-000</b>	20 x 1"	10	+90°C	5	160	<b>35,10</b>
<b>62-901-2515-000</b>	25 x 1/2"	10	+90°C	5	120	<b>41,30</b>
<b>62-901-2520-000</b>	25 x 3/4"	10	+90°C	5	120	<b>46,35</b>
<b>62-901-2525-000</b>	25 x 1"	10	+90°C	6	144	<b>42,97</b>
<b>62-901-3225-000</b>	32 x 1"	10	+90°C	5	120	<b>69,60</b>
<b>62-901-3232-000</b>	32 x 1 1/4"	10	+90°C	5	90	<b>78,95</b>
<b>62-901-4032-000</b>	40 x 1 1/4"	10	+90°C	1	60	<b>110,53</b>
<b>62-901-4040-000</b>	40 x 1 1/2"	10	+90°C	1	56	<b>131,58</b>
<b>62-901-5040-000</b>	50 x 1 1/2"	10	+90°C	1	48	<b>144,74</b>
<b>62-901-5050-000</b>	50 x 2"	10	+90°C	1	30	<b>178,95</b>
<b>62-901-6340-000</b>	63 x 1 1/2"	10	+90°C	1	20	<b>300,00</b>
<b>62-901-6350-000</b>	63 x 2"	10	+90°C	1	20	<b>302,63</b>

## 902

**PERFEKT SYSTEM PLUS**  
Mufa zaprasowywana GW

**G** GRUPA RABATOWA

\*) dostępny w III kwartale 2024

PERFEKT<sub>SYSTEM</sub>

indeks	wielkość	PN	Tmax	pakowanie		cena netto [zł]
<b>62-902-1615-000</b>	16 x 1/2"	10	+90°C	3	240	<b>21,38</b>
<b>62-902-1620-000</b>	16 x 3/4"	10	+90°C	5	160	<b>26,95</b>
<b>62-902-1815-000</b>	18 x 1/2"	10	+90°C	3	240	<b>24,00</b>
<b>62-902-1820-000</b>	18 x 3/4"	10	+90°C	5	160	<b>27,50</b>
<b>62-902-2015-000</b>	20 x 1/2"	10	+90°C	3	240	<b>23,43</b>
<b>62-902-2020-000</b>	20 x 3/4"	10	+90°C	5	160	<b>26,40</b>
<b>62-902-2520-000</b>	25 x 3/4"	10	+90°C	5	120	<b>36,40</b>
<b>62-902-2525-000</b>	25 x 1"	10	+90°C	5	135	<b>49,12</b>
<b>62-902-3225-000</b>	32 x 1"	10	+90°C	5	135	<b>74,00</b>
<b>62-902-4032-000</b>	40 x 1 1/4"	10	+90°C	1	63	<b>115,79</b>
<b>62-902-4040-000</b>	40 x 1 1/2"	10	+90°C	1	48	<b>118,42</b>
<b>62-902-5040-000</b>	50 x 1 1/2"	10	+90°C	1	48	<b>142,11</b>
<b>62-902-6350-000</b>	63 x 2"	10	+90°C	1	20	<b>284,21</b>

## 902/O

**PERFEKT SYSTEM PLUS**  
Półśrubunek  
zaprasowywany GW

**G** GRUPA RABATOWA

\*) dostępny w III kwartale 2024

PERFEKT<sub>SYSTEM</sub>

indeks	wielkość	PN	Tmax	pakowanie		cena netto [zł]
<b>62-902-1615-001</b>	16 x 1/2"	10	+90°C	5	240	<b>32,80</b>
<b>62-902-1820-001</b>	18 x 3/4"	10	+90°C	4	220	<b>33,00</b>
<b>62-902-2015-001</b>	20 x 1/2"	10	+90°C	5	240	<b>39,47</b>
<b>62-902-2020-001</b>	20 x 3/4"	10	+90°C	5	160	<b>46,55</b>

## 903

**PERFEKT SYSTEM PLUS**  
 Złączka zaprasowywana

GRUPA RABATOWA

\*) dostępny w III kwartale 2024

**PERFEKT** SYSTEM<sup>+</sup>

indeks	wielkość	PN	Tmax	pakowanie		cena netto [zł]
<b>62-903-0160-000</b>	16	10	+90°C	5	240	<b>16,61</b>
<b>62-903-0180-000</b>	18	10	+90°C	5	200	<b>16,80</b>
<b>62-903-0200-000</b>	20	10	+90°C	5	200	<b>20,82</b>
<b>62-903-0250-000</b>	25	10	+90°C	5	120	<b>38,13</b>
<b>62-903-0320-000</b>	32	10	+90°C	5	100	<b>69,58</b>
<b>62-903-0400-000</b>	40	10	+90°C	1	42	<b>113,16</b>
<b>62-903-0500-000</b>	50	10	+90°C	1	33	<b>167,11</b>
<b>62-903-0630-000</b>	63	10	+90°C	1	15	<b>344,74</b>
<b>62-903-1816-000</b>	18 x 16	10	+90°C	5	200	<b>16,80</b>
<b>62-903-2016-000</b>	20 x 16	10	+90°C	5	200	<b>19,95</b>
<b>62-903-2018-000</b>	20 x 18	10	+90°C	5	200	<b>22,00</b>
<b>62-903-2516-000</b>	25 x 16	10	+90°C	5	120	<b>31,05</b>
<b>62-903-2518-000</b>	25 x 18	10	+90°C	5	120	<b>27,82</b>
<b>62-903-2520-000</b>	25 x 20	10	+90°C	5	120	<b>43,70</b>
<b>62-903-3216-000</b>	32 x 16	10	+90°C	5	120	<b>43,93</b>
<b>62-903-3218-000</b>	32 x 18	10	+90°C	5	120	<b>42,31</b>
<b>62-903-3220-000</b>	32 x 20	10	+90°C	5	80	<b>47,37</b>
<b>62-903-3225-000</b>	32 x 25	10	+90°C	1	100	<b>56,50</b>
<b>62-903-4025-000</b>	40 x 25	10	+90°C	1	42	<b>107,89</b>
<b>62-903-4032-000</b>	40 x 32	10	+90°C	1	42	<b>115,79</b>
<b>62-903-5032-000</b>	50 x 32	10	+90°C	1	40	<b>118,42</b>
<b>62-903-5040-000</b>	50 x 40	10	+90°C	1	40	<b>144,74</b>
<b>62-903-6340-000</b>	63 x 40	10	+90°C	1	18	<b>244,74</b>
<b>62-903-6350-000</b>	63 x 50	10	+90°C	1	18	<b>300,00</b>

## 904

**PERFEKT SYSTEM PLUS**  
 Kolano zaprasowywane GZ

GRUPA RABATOWA

\*) dostępny w III kwartale 2024

**PERFEKT** SYSTEM<sup>+</sup>

indeks	wielkość	PN	Tmax	pakowanie		cena netto [zł]
<b>62-904-1615-000</b>	16 x 1/2"	10	+90°C	5	200	<b>25,76</b>
<b>62-904-1620-000</b>	16 x 3/4"	10	+90°C	5	120	<b>35,80</b>
<b>62-904-1815-000</b>	18 x 1/2"	10	+90°C	5	120	<b>28,50</b>
<b>62-904-2015-000</b>	20 x 1/2"	10	+90°C	2	190	<b>30,45</b>
<b>62-904-2020-000</b>	20 x 3/4"	10	+90°C	2	160	<b>37,60</b>
<b>62-904-2520-000</b>	25 x 3/4"	10	+90°C	5	80	<b>47,88</b>
<b>62-904-2525-000</b>	25 x 1"	10	+90°C	5	80	<b>57,24</b>
<b>62-904-3225-000</b>	32 x 1"	10	+90°C	2	80	<b>89,90</b>

## 905

**PERFEKT SYSTEM PLUS**  
 Kolano zaprasowywane GW

GRUPA RABATOWA

\*) dostępny w III kwartale 2024

**PERFEKT** SYSTEM<sup>+</sup>

indeks	wielkość	PN	Tmax	pakowanie		cena netto [zł]
<b>62-905-1615-000</b>	16 x 1/2"	10	+90°C	5	200	<b>23,56</b>
<b>62-905-2015-000</b>	20 x 1/2"	10	+90°C	6	180	<b>31,26</b>
<b>62-905-2020-000</b>	20 x 3/4"	10	+90°C	6	144	<b>37,00</b>
<b>62-905-2520-000</b>	25 x 3/4"	10	+90°C	6	120	<b>50,68</b>
<b>62-905-2525-000</b>	25 x 1"	10	+90°C	6	120	<b>60,23</b>
<b>62-905-3225-000</b>	32 x 1"	10	+90°C	2	72	<b>81,47</b>

## 906

**PERFEKT SYSTEM PLUS**  
 Kolano zaprasowywane

GRUPA RABATOWA

**PERFEKT** SYSTEM<sup>+</sup>

indeks	wielkość	PN	Tmax	pakowanie		cena netto [zł]
<b>62-906-0160-000</b>	16	10	+90°C	5	160	<b>23,40</b>
<b>62-906-0180-000</b>	18	10	+90°C	8	160	<b>24,00</b>
<b>62-906-0200-000</b>	20	10	+90°C	8	160	<b>31,36</b>
<b>62-906-0250-000</b>	25	10	+90°C	4	80	<b>47,28</b>
<b>62-906-0320-000</b>	32	10	+90°C	2	72	<b>84,97</b>
<b>62-906-0400-000</b>	40	10	+90°C	2	30	<b>139,47</b>
<b>62-906-0500-000</b>	50	10	+90°C	1	24	<b>205,26</b>
<b>62-906-0630-000</b>	63	10	+90°C	1	10	<b>381,58</b>

907

**PERFEKT SYSTEM PLUS**  
 Złączka ślepiąca

GRUPA RABATOWA

**PERFEKT** SYSTEM<sup>+</sup>

indeks	wielkość	PN	Tmax	pakowanie		cena netto [zł]
<b>62-907-0160-000</b>	16 x 1/2"	10	+90°C	20	480	<b>9,80</b>
<b>62-907-0200-000</b>	20 x 3/4"	10	+90°C	20	320	<b>14,70</b>

908

**PERFEKT SYSTEM PLUS**  
 Kolano zaprasowywane  
 z mocowaniem

GRUPA RABATOWA

\*) dostępny w III kwartale 2024

**PERFEKT** SYSTEM<sup>+</sup>

indeks	wielkość	PN	Tmax	pakowanie		cena netto [zł]
<b>62-908-1615-000</b>	16 x 1/2"	10	+90°C	7	168	<b>33,78</b>
<b>62-908-1815-000</b>	18 x 1/2"	10	+90°C	5	80	<b>35,15</b>
<b>62-908-2015-000</b>	20 x 1/2"	10	+90°C	5	80	<b>40,85</b>

909

**PERFEKT SYSTEM PLUS**  
 Trójnik zaprasowywany

GRUPA RABATOWA

\*) dostępny w III kwartale 2024

**PERFEKT** SYSTEM<sup>+</sup>

indeks	wielkość	PN	Tmax	pakowanie		cena netto [zł]
<b>62-909-0160-000</b>	16	10	+90°C	4	144	<b>30,63</b>
<b>62-909-0180-000</b>	18	10	+90°C	2	100	<b>34,50</b>
<b>62-909-0200-000</b>	20	10	+90°C	2	100	<b>39,91</b>
<b>62-909-0250-000</b>	25	10	+90°C	2	48	<b>71,48</b>
<b>62-909-0320-000</b>	32	10	+90°C	4	32	<b>106,00</b>
<b>62-909-0400-000</b>	40	10	+90°C	1	18	<b>202,63</b>
<b>62-909-0500-000</b>	50	10	+90°C	1	12	<b>310,53</b>
<b>62-909-0630-000</b>	63	10	+90°C	1	6	<b>631,58</b>

910

**PERFEKT SYSTEM PLUS**  
 Trójnik zaprasowywany

GRUPA RABATOWA

\*) dostępny w III kwartale 2024

**PERFEKT** SYSTEM<sup>+</sup>

indeks	wielkość	PN	Tmax	pakowanie		cena netto [zł]
<b>62-910-1620-000</b>	16 x 20 x 16	10	+90°C	5	120	<b>38,82</b>
<b>62-910-1816-000</b>	18 x 16 x 16	10	+90°C	5	120	<b>36,80</b>
<b>62-910-1816-180</b>	18 x 16 x 18	10	+90°C	5	120	<b>37,80</b>
<b>62-910-2016-000</b>	20 x 16 x 16	10	+90°C	5	120	<b>38,97</b>
<b>62-910-2016-200</b>	20 x 16 x 20	10	+90°C			<b>38,67</b>
<b>62-910-2018-200</b>	20 x 18 x 20	10	+90°C	5	120	<b>36,10</b>
<b>62-910-2020-000</b>	20 x 20 x 16	10	+90°C	5	100	<b>38,35</b>
<b>62-910-2516-200</b>	25 x 16 x 20	10	+90°C	4	64	<b>56,29</b>
<b>62-910-2516-250</b>	25 x 16 x 25	10	+90°C			<b>64,40</b>
<b>62-910-2518-250</b>	25 x 18 x 25	10	+90°C	4	80	<b>49,80</b>
<b>62-910-2520-200</b>	25 x 20 x 20	10	+90°C	4	64	<b>67,70</b>
<b>62-910-2520-250</b>	25 x 20 x 25	10	+90°C	1	64	<b>59,30</b>
<b>62-910-2525-200</b>	25 x 25 x 20	10	+90°C			<b>69,56</b>
<b>62-910-2532-250</b>	25 x 32 x 25	10	+90°C	5	40	<b>88,90</b>
<b>62-910-3216-320</b>	32 x 16 x 32	10	+90°C	4	48	<b>84,20</b>
<b>62-910-3220-320</b>	32 x 20 x 32	10	+90°C	5	40	<b>100,00</b>
<b>62-910-3225-320</b>	32 x 25 x 32	10	+90°C	2	40	<b>111,10</b>
<b>62-910-4020-400</b>	40 x 20 x 40	10	+90°C	1	21	<b>178,95</b>
<b>62-910-4025-400</b>	40 x 25 x 40	10	+90°C	1	21	<b>181,58</b>
<b>62-910-4032-320</b>	40 x 32 x 32	10	+90°C	1	21	<b>186,84</b>
<b>62-910-4032-400</b>	40 x 32 x 40	10	+90°C	1	21	<b>189,47</b>
<b>62-910-5025-500</b>	50 x 25 x 50	10	+90°C	1	11	<b>271,05</b>
<b>62-910-5032-500</b>	50 x 32 x 50	10	+90°C	1	10	<b>273,68</b>
<b>62-910-5040-500</b>	50 x 40 x 50	10	+90°C	1	10	<b>310,53</b>
<b>62-910-6340-630</b>	63 x 40 x 63	10	+90°C	1	7	<b>547,37</b>
<b>62-910-6350-630</b>	63 x 50 x 63	10	+90°C	1	7	<b>578,95</b>

911

**PERFEKT SYSTEM PLUS**  
 Trójnik zaprasowywany GZ

GRUPA RABATOWA

PERFEKT<sub>SYSTEM</sub>

indeks	wielkość	PN	Tmax	pakowanie		cena netto [zł]
<b>62-911-1615-000</b>	16 x 1/2"	10	+90°C	5	120	<b>39,78</b>
<b>62-911-2015-000</b>	20 x 1/2"	10	+90°C	5	80	<b>47,57</b>
<b>62-911-2020-000</b>	20 x 3/4"	10	+90°C	5	80	<b>58,85</b>
<b>62-911-2520-000</b>	25 x 3/4"	10	+90°C	1	64	<b>71,75</b>
<b>62-911-3225-000</b>	32 x 1"	10	+90°C	1	40	<b>126,40</b>

912

**PERFEKT SYSTEM PLUS**  
 Trójnik zaprasowywany GW

GRUPA RABATOWA

PERFEKT<sub>SYSTEM</sub>

indeks	wielkość	PN	Tmax	pakowanie		cena netto [zł]
<b>62-912-1615-000</b>	16 x 1/2"	10	+90°C	5	120	<b>37,36</b>
<b>62-912-2015-000</b>	20 x 1/2"	10	+90°C	5	120	<b>47,80</b>
<b>62-912-2020-000</b>	20 x 3/4"	10	+90°C	5	80	<b>53,24</b>
<b>62-912-2515-000</b>	25 x 1/2"	10	+90°C	1	72	<b>69,85</b>
<b>62-912-2520-000</b>	25 x 3/4"	10	+90°C	1	64	<b>83,48</b>
<b>62-912-2525-000</b>	25 x 1"	10	+90°C	1	54	<b>91,75</b>
<b>62-912-3225-000</b>	32 x 1"	10	+90°C	3	48	<b>125,50</b>
<b>62-912-4032-000</b>	40 x 1 1/4"	10	+90°C	1	24	<b>207,89</b>
<b>62-912-5040-000</b>	50 x 1 1/2"			1	18	<b>342,11</b>

913

**PERFEKT SYSTEM PLUS**  
 Listwa do baterii

GRUPA RABATOWA

PERFEKT<sub>SYSTEM</sub>

indeks	wielkość	PN	Tmax	pakowanie		cena netto [zł]
<b>62-913-0100-000</b>	16 x 1/2" / 100	10	+90°C	1	15	<b>91,95</b>
<b>62-913-0150-000</b>	16 x 1/2" / 150	10	+90°C	1	15	<b>96,21</b>

\*) dostępny w III kwartale 2024

746

**PERFEKT SYSTEM**  
 Korek zaprasowywany GZ

GRUPA RABATOWA

PERFEKT<sub>SYSTEM</sub>

indeks	wielkość	PN	Tmax	pakowanie		cena netto [zł]
<b>62-746-0160-000</b>	16 x 2,0	10	+90°C	10		<b>7,00</b>
<b>62-746-0200-000</b>	20 x 2,0	10	+90°C	10		<b>10,50</b>

731

**PERFEKT SYSTEM**  
 Nypel zaprasowywany GZ

GRUPA RABATOWA

PERFEKT<sub>SYSTEM</sub>

indeks	wielkość	PN	Tmax	pakowanie		cena netto [zł]
<b>62-731-1615-000</b>	16 x 1/2"	10	+90°C	10	700	<b>15,42</b>
<b>62-731-1620-000</b>	16 x 3/4"	10	+90°C	10	600	<b>19,08</b>
<b>62-731-2015-000</b>	20 x 1/2"	10	+90°C	5	600	<b>19,91</b>
<b>62-731-2020-000</b>	20 x 3/4"	10	+90°C	5	500	<b>20,39</b>
<b>62-731-2515-000</b>	25 x 1/2"	10	+90°C	2	140	<b>35,11</b>
<b>62-731-2520-000</b>	25 x 3/4"	10	+90°C	2	500	<b>41,24</b>
<b>62-731-2525-000</b>	25 x 1"	10	+90°C	2	250	<b>38,19</b>
<b>62-731-3225-000</b>	32 x 1"	10	+90°C	1	150	<b>61,87</b>

732

## PERFEKT SYSTEM

Mufa zaprasowywana GW



GRUPA RABATOWA

PERFEKT<sup>SYSTEM</sup>

indeks	wielkość	PN	Tmax	pakowanie		cena netto [zł]
<b>62-732-1615-000</b>	16 x 1/2"	10	+90°C	10	600	<b>18,99</b>
<b>62-732-1620-000</b>	16 x 3/4"	10	+90°C	5	500	<b>22,94</b>
<b>62-732-2015-000</b>	20 x 1/2"	10	+90°C	5	500	<b>20,81</b>
<b>62-732-2020-000</b>	20 x 3/4"	10	+90°C	5	450	<b>22,91</b>
<b>62-732-2520-000</b>	25 x 3/4"	10	+90°C	2	150	<b>31,95</b>
<b>62-732-2525-000</b>	25 x 1"	10	+90°C	2	250	<b>43,65</b>
<b>62-732-3225-000</b>	32 x 1"	10	+90°C	1	150	<b>64,20</b>

733

## PERFEKT SYSTEM

Złączka zaprasowywana prosta



GRUPA RABATOWA

PERFEKT<sup>SYSTEM</sup>

indeks	wielkość	PN	Tmax	pakowanie		cena netto [zł]
<b>62-733-0160-000</b>	16	10	+90°C	10	220	<b>14,75</b>
<b>62-733-0200-000</b>	20	10	+90°C	5	400	<b>18,49</b>
<b>62-733-0250-000</b>	25	10	+90°C	5	500	<b>32,10</b>
<b>62-733-0320-000</b>	32	10	+90°C	2	250	<b>59,22</b>
<b>62-733-2016-000</b>	20 x 16	10	+90°C	2	400	<b>17,75</b>
<b>62-733-2516-000</b>	25 x 16	10	+90°C	2	160	<b>26,42</b>
<b>62-733-2520-000</b>	25 x 20	10	+90°C	1	150	<b>37,99</b>
<b>62-733-3225-000</b>	32 x 25	10	+90°C	1	150	<b>50,06</b>

734

## PERFEKT SYSTEM

Kolano zaprasowywane GZ



GRUPA RABATOWA

PERFEKT<sup>SYSTEM</sup>

indeks	wielkość	PN	Tmax	pakowanie		cena netto [zł]
<b>62-734-1615-000</b>	16 x 1/2"	10	+90°C	10	500	<b>22,90</b>
<b>62-734-1620-000</b>	16 x 3/4"	10	+90°C	10	350	<b>30,92</b>
<b>62-734-2015-000</b>	20 x 1/2"	10	+90°C	5	350	<b>26,46</b>
<b>62-734-2020-000</b>	20 x 3/4"	10	+90°C	5	280	<b>33,33</b>
<b>62-734-2520-000</b>	25 x 3/4"	10	+90°C	2	150	<b>45,05</b>
<b>62-734-2525-000</b>	25 x 1"	10	+90°C	2	200	<b>47,72</b>
<b>62-734-3225-000</b>	32 x 1"	10	+90°C	1	100	<b>79,62</b>

735

## PERFEKT SYSTEM

Kolano zaprasowywane GW



GRUPA RABATOWA

PERFEKT<sup>SYSTEM</sup>

indeks	wielkość	PN	Tmax	pakowanie		cena netto [zł]
<b>62-735-1615-000</b>	16 x 1/2"	10	+90°C	10	400	<b>20,94</b>
<b>62-735-2015-000</b>	20 x 1/2"	10	+90°C	5	300	<b>27,78</b>
<b>62-735-2020-000</b>	20 x 3/4"	10	+90°C	5	260	<b>32,70</b>
<b>62-735-2520-000</b>	25 x 3/4"	10	+90°C	2	180	<b>41,64</b>
<b>62-735-2525-000</b>	25 x 1"	10	+90°C	2	150	<b>54,83</b>
<b>62-735-3225-000</b>	32 x 1"	10	+90°C	1	100	<b>68,61</b>

736

## PERFEKT SYSTEM

Kolano zaprasowywane



GRUPA RABATOWA

PERFEKT<sup>SYSTEM</sup>

indeks	wielkość	PN	Tmax	pakowanie		cena netto [zł]
<b>62-736-0160-000</b>	16	10	+90°C	10	600	<b>20,84</b>
<b>62-736-0200-000</b>	20	10	+90°C	5	300	<b>27,86</b>
<b>62-736-0250-000</b>	25	10	+90°C	2	150	<b>42,03</b>
<b>62-736-0320-000</b>	32	10	+90°C	1	100	<b>72,32</b>

738

## PERFEKT SYSTEM

Kolano zaprasowywane z mocowaniem



GRUPA RABATOWA

PERFEKT<sup>SYSTEM</sup>

indeks	wielkość	PN	Tmax	pakowanie		cena netto [zł]
<b>62-738-1615-000</b>	16 x 1/2"	10	+90°C	10	240	<b>30,02</b>
<b>62-738-2015-000</b>	20 x 1/2"	10	+90°C	5	220	<b>36,32</b>

739

## PERFEKT SYSTEM

Trójnik zaprasowywany GZ



indeks	wielkość	PN	Tmax	pakowanie	cena netto [zł]
<b>62-739-1615-000</b>	16 x 1/2"	10	+90°C	10 300	<b>33,85</b>
<b>62-739-2015-000</b>	20 x 1/2"	10	+90°C	5 250	<b>40,48</b>
<b>62-739-2020-000</b>	20 x 3/4"	10	+90°C	5 200	<b>50,09</b>
<b>62-739-2520-000</b>	25 x 3/4"	10	+90°C	2 150	<b>67,47</b>
<b>62-739-2525-000</b>	25 x 1"	10	+90°C	2 100	<b>91,95</b>
<b>62-739-3225-000</b>	32 x 1"	10	+90°C	1 90	<b>107,55</b>



GRUPA RABATOWA



73A

## PERFEKT SYSTEM

Trójnik zaprasowywany GW



indeks	wielkość	PN	Tmax	pakowanie	cena netto [zł]
<b>62-071-1615-000</b>	16 x 1/2"	10	+90°C	10 300	<b>31,80</b>
<b>62-071-1620-000</b>	16 x 3/4"	10	+90°C	10 100	<b>32,20</b>
<b>62-071-2015-000</b>	20 x 1/2"	10	+90°C	5 250	<b>40,82</b>
<b>62-071-2020-000</b>	20 x 3/4"	10	+90°C	5 200	<b>44,85</b>
<b>62-071-2520-000</b>	25 x 3/4"	10	+90°C	2 150	<b>70,30</b>
<b>62-071-2525-000</b>	25 x 1"	10	+90°C	2 100	<b>77,26</b>
<b>62-071-3225-000</b>	32 x 1"	10	+90°C	1 90	<b>105,68</b>



GRUPA RABATOWA



73B

## PERFEKT SYSTEM

Trójnik zaprasowywany



indeks	wielkość	PN	Tmax	pakowanie	cena netto [zł]
<b>62-73B-0160-000</b>	16	10	+90°C	10 400	<b>27,21</b>
<b>62-73B-0200-000</b>	20	10	+90°C	5 200	<b>35,48</b>
<b>62-73B-0250-000</b>	25	10	+90°C	2 150	<b>60,19</b>
<b>62-73B-0320-000</b>	32	10	+90°C	1 90	<b>89,15</b>



GRUPA RABATOWA



73C

## PERFEKT SYSTEM

Trójnik zaprasowywany



indeks	wielkość	PN	Tmax	pakowanie	cena netto [zł]
<b>62-73C-1620-000</b>	16 x 20 x 16	10	+90°C	10 300	<b>34,51</b>
<b>62-73C-2016-000</b>	20 x 16 x 16	10	+90°C	5 250	<b>34,58</b>
<b>62-73C-2016-001</b>	20 x 16 x 20	10	+90°C	5 250	<b>34,37</b>
<b>62-73C-2020-000</b>	20 x 20 x 16	10	+90°C	5 250	<b>34,07</b>
<b>62-73C-2025-000</b>	20 x 25 x 20	10	+90°C	2 160	<b>48,86</b>
<b>62-73C-2516-001</b>	25 x 16 x 20	10	+90°C		<b>34,85</b>
<b>62-73C-2516-000</b>	25 x 16 x 25	10	+90°C	2 150	<b>57,23</b>
<b>62-73C-2520-000</b>	25 x 20 x 25	10	+90°C	2 150	<b>51,56</b>
<b>62-73C-2520-001</b>	25 x 20 x 20	10	+90°C	2 150	<b>58,80</b>
<b>62-73C-2525-000</b>	25 x 25 x 20	10	+90°C	2 150	<b>60,48</b>
<b>62-73C-3216-000</b>	32 x 16 x 32	10	+90°C		<b>64,95</b>
<b>62-73C-3220-000</b>	32 x 20 x 32	10	+90°C	1 90	<b>84,22</b>
<b>62-73C-3225-000</b>	32 x 25 x 32	10	+90°C	1 100	<b>93,79</b>



GRUPA RABATOWA



732/O

## PERFEKT SYSTEM

Półśrubunek zaprasowywany



indeks	wielkość	PN	Tmax	pakowanie	cena netto [zł]
<b>62-732-1615-001</b>	16 x 1/2"	10	+90°C	1 300	<b>28,60</b>
<b>62-732-2020-001</b>	20 x 3/4"	10	+90°C	1 250	<b>37,23</b>
<b>62-732-2525-001</b>	25 x 1"	10	+90°C	1 100	<b>48,78</b>



GRUPA RABATOWA



740

## PERFEKT SYSTEM

Listwa do baterii



indeks	wielkość	PN	Tmax	pakowanie	cena netto [zł]
<b>62-740-0100-000</b>	16 x 1/2" x L-100	10	+90°C	1 60	<b>73,56</b>
<b>62-740-0150-000</b>	16 x 1/2" x L-150	10	+90°C	1 60	<b>76,98</b>



GRUPA RABATOWA



741

**PERFEKT SYSTEM**  
Listwa z cyrkulacją  
do baterii

PERFEKT<sup>2</sup>SYSTEM

indeks	wielkość	PN	Tmax	pakowanie		cena netto [zł]
<b>62-741-0100-000</b>	16 x 1/2" x L-100	10	+90°C	1	60	<b>87,50</b>
<b>62-741-0150-000</b>	16 x 1/2" x L-150	10	+90°C	1	50	<b>90,87</b>



GRUPA RABATOWA

742

**PERFEKT SYSTEM**  
Kolanko  
zaprasowywane typ L  
do grzejnika

PERFEKT<sup>2</sup>SYSTEM

indeks	wielkość	PN	Tmax	pakowanie		cena netto [zł]
<b>62-742-1615-000</b>	16 x L-200	10	+90°C	1	100	<b>75,01</b>



GRUPA RABATOWA

745

**PERFEKT SYSTEM**  
Zespół kolan  
z mocowaniem z rurką Cu

PERFEKT<sup>2</sup>SYSTEM

indeks	wielkość	PN	Tmax	pakowanie		cena netto [zł]
<b>62-745-1615-000</b>	16 x L-200	10	+90°C	1	100	<b>125,15</b>



GRUPA RABATOWA

730

**PERFEKT SYSTEM**  
Tuleja do złączek  
zaprasowywanych

PERFEKT<sup>2</sup>SYSTEM

indeks	wielkość	PN	Tmax	pakowanie		cena netto [zł]
<b>62-730-0160-000</b>	16	10	+90°C	100	800	<b>1,73</b>
<b>62-730-0200-000</b>	20	10	+90°C	50	400	<b>2,11</b>
<b>62-730-0250-000</b>	25	10	+90°C	50	200	<b>5,08</b>



GRUPA RABATOWA

701

**PERFEKT SYSTEM**  
Nypel skręcany GZ

PERFEKT<sup>2</sup>SYSTEM

indeks	wielkość	PN	Tmax	pakowanie		cena netto [zł]
<b>61-001-1615-000</b>	16 x 1/2"	10	+90°C	10	400	<b>8,12</b>
<b>61-001-2015-000</b>	20 x 1/2"	10	+90°C	5	200	<b>15,26</b>
<b>61-001-2020-000</b>	20 x 3/4"	10	+90°C	5	200	<b>15,83</b>
<b>61-001-2520-000</b>	25 x 3/4"	10	+90°C	2	120	<b>28,74</b>
<b>61-001-2525-000</b>	25 x 1"	10	+90°C	2	100	<b>27,63</b>
<b>61-001-3225-000</b>	32 x 1"	10	+90°C	1	50	<b>38,58</b>



GRUPA RABATOWA

701/B

**PERFEKT SYSTEM**  
Nypel skręcany  
z wymiowaną końcówką  
do belki rozdzielacza GZ

PERFEKT<sup>2</sup>SYSTEM

indeks	wielkość	PN	Tmax	pakowanie		cena netto [zł]
<b>61-001-1615-001</b>	16 x 1/2"	10	+90°C	10	100	<b>10,71</b>



GRUPA RABATOWA

702

**PERFEKT SYSTEM**  
Mufa skręcana GW

PERFEKT<sup>2</sup>SYSTEM

indeks	wielkość	PN	Tmax	pakowanie		cena netto [zł]
<b>61-002-1615-000</b>	16 x 1/2"	10	+90°C	10	400	<b>9,29</b>
<b>61-002-2015-000</b>	20 x 1/2"	10	+90°C	5	200	<b>17,88</b>
<b>61-002-2020-000</b>	20 x 3/4"	10	+90°C	5	200	<b>17,60</b>
<b>61-002-2520-000</b>	25 x 3/4"	10	+90°C	2	100	<b>35,48</b>
<b>61-002-2525-000</b>	25 x 1"	10	+90°C	2	120	<b>42,28</b>
<b>61-002-3225-000</b>	32 x 1"	10	+90°C	1	50	<b>44,08</b>



GRUPA RABATOWA

**703**

**PERFEKT SYSTEM**  
Mufa skręciana



GRUPA RABATOWA

**PERFEKT<sup>2</sup>SYSTEM**

indeks	wielkość	PN	Tmax	pakowanie		cena netto [zł]
<b>61-003-0160-000</b>	16	10	+90°C	10	200	<b>15,08</b>
<b>61-003-0200-000</b>	20	10	+90°C	5	160	<b>23,95</b>
<b>61-003-1620-000</b>	16 x 20	10	+90°C	5	100	<b>22,10</b>
<b>61-003-2520-000</b>	25 x 20	10	+90°C	2	100	<b>35,92</b>

**704**

**PERFEKT SYSTEM**  
Kolano skręcane GZ



GRUPA RABATOWA

**PERFEKT<sup>2</sup>SYSTEM**

indeks	wielkość	PN	Tmax	pakowanie		cena netto [zł]
<b>61-004-1615-000</b>	16 x 1/2"	10	+90°C	10	200	<b>12,44</b>
<b>61-004-2015-000</b>	20 x 1/2"	10	+90°C	5	180	<b>19,81</b>
<b>61-004-2020-000</b>	20 x 3/4"	10	+90°C	5	120	<b>21,10</b>
<b>61-004-2525-000</b>	25 x 1"	10	+90°C	2	100	<b>37,74</b>
<b>61-004-3225-000</b>	32 x 1"	10	+90°C	1	50	<b>49,59</b>

**705**

**PERFEKT SYSTEM**  
Kolano skręcane GW



GRUPA RABATOWA

**PERFEKT<sup>2</sup>SYSTEM**

indeks	wielkość	PN	Tmax	pakowanie		cena netto [zł]
<b>61-005-1615-000</b>	16 x 1/2"	10	+90°C	10	200	<b>14,40</b>
<b>61-005-2015-000</b>	20 x 1/2"	10	+90°C	5	180	<b>23,20</b>
<b>61-005-2020-000</b>	20 x 3/4"	10	+90°C	5	120	<b>24,60</b>
<b>61-005-2525-000</b>	25 x 1"	10	+90°C	2	100	<b>45,46</b>
<b>61-005-3225-000</b>	32 x 1"	10	+90°C	1	50	<b>58,79</b>

**706**

**PERFEKT SYSTEM**  
Kolano skręcane



GRUPA RABATOWA

**PERFEKT<sup>2</sup>SYSTEM**

indeks	wielkość	PN	Tmax	pakowanie		cena netto [zł]
<b>61-006-0160-000</b>	16	10	+90°C	10	160	<b>16,98</b>
<b>61-006-0200-000</b>	20	10	+90°C	5	120	<b>28,85</b>
<b>61-006-0250-000</b>	25	10	+90°C	2	80	<b>39,89</b>
<b>61-006-2520-000</b>	25 x 20	10	+90°C	2	100	<b>41,96</b>
<b>61-006-0320-000</b>	32	10	+90°C	1	50	<b>42,41</b>

**707**

**PERFEKT SYSTEM**  
Kolano skręcane z mocowaniem GW



GRUPA RABATOWA

**PERFEKT<sup>2</sup>SYSTEM**

indeks	wielkość	PN	Tmax	pakowanie		cena netto [zł]
<b>61-007-1615-000</b>	16 x 1/2"	10	+90°C	10	120	<b>17,60</b>
<b>61-007-2015-000</b>	20 x 1/2"	10	+90°C	5	80	<b>25,60</b>
<b>61-007-2020-000</b>	20 x 3/4"	10	+90°C	5	80	<b>40,20</b>

**708**

**PERFEKT SYSTEM**  
Trójnik skręcany GZ



GRUPA RABATOWA

**PERFEKT<sup>2</sup>SYSTEM**

indeks	wielkość	PN	Tmax	pakowanie		cena netto [zł]
<b>61-008-1615-000</b>	16 x 1/2"	10	+90°C	10	160	<b>19,60</b>
<b>61-008-2015-000</b>	20 x 1/2"	10	+90°C	5	120	<b>29,03</b>
<b>61-008-2020-000</b>	20 x 3/4"	10	+90°C	5	120	<b>36,95</b>
<b>61-008-2520-000</b>	25 x 3/4"	10	+90°C	2	60	<b>58,68</b>
<b>61-008-2525-000</b>	25 x 1"	10	+90°C	2	50	<b>67,32</b>
<b>61-008-3225-000</b>	32 x 1"	10	+90°C	1	50	<b>78,50</b>

**709**

**PERFEKT SYSTEM**  
Trójnik skręcany GW



GRUPA RABATOWA

**PERFEKT<sup>2</sup>SYSTEM**

indeks	wielkość	PN	Tmax	pakowanie		cena netto [zł]
<b>61-009-1615-000</b>	16 x 1/2"	10	+90°C	10	160	<b>22,24</b>
<b>61-009-2015-000</b>	20 x 1/2"	10	+90°C	5	120	<b>35,80</b>
<b>61-009-2020-000</b>	20 x 3/4"	10	+90°C	5	80	<b>41,90</b>
<b>61-009-2520-000</b>	25 x 3/4"	10	+90°C	2	60	<b>64,09</b>
<b>61-009-2525-000</b>	25 x 1"	10	+90°C	1	50	<b>67,32</b>
<b>61-009-3225-000</b>	32 x 1"	10	+90°C	2	50	<b>79,01</b>



## 70A

PERFEKT SYSTEM  
Trójnik skręcanyPERFEKT<sup>2</sup> SYSTEM

G GRUPA RABATOWA

indeks	wielkość	PN	Tmax	pakowanie		cena netto [zł]
61-010-0160-000	16	10	+90°C	10	160	22,92
61-010-0200-000	20	10	+90°C	5	80	39,42
61-010-0250-000	25	10	+90°C	2	60	63,26
61-010-0320-000	32	10	+90°C	1	50	79,30
61-010-1616-000	20 x 16 x 16	10	+90°C	5	120	36,47
61-010-1620-000	20 x 16 x 20	10	+90°C	5	100	37,58
61-010-1625-000	25 x 20 x 16	10	+90°C	2	60	54,34
61-010-2520-000	25 x 20 x 25	10	+90°C	2	60	54,11
61-010-3225-000	32 x 25 x 32	10	+90°C	2	50	93,73

## 601

## Nypel skręcany GZ



D GRUPA RABATOWA

indeks	wielkość	PN	Tmax	pakowanie		cena netto [zł]
61-601-1615-000	16 x 1/2"	10	+90°C	10	280	7,92
61-601-2015-000	20 x 1/2"	10	+90°C	5	150	12,68
61-601-2020-000	20 x 3/4"	10	+90°C	5	150	14,99
61-601-2520-000	25 x 3/4"	10	+90°C	dostępne w II kwartale		
61-601-2525-000	25 x 1"	10	+90°C	dostępne w II kwartale		

## 602

## Mufa skręcana GW



D GRUPA RABATOWA

indeks	wielkość	PN	Tmax	pakowanie		cena netto [zł]
61-602-1615-000	16 x 1/2"	10	+90°C	10	200	9,22
61-602-2015-000	20 x 1/2"	10	+90°C	5	150	12,32
61-602-2020-000	20 x 3/4"	10	+90°C	5	150	15,09
61-602-2520-000	25 x 3/4"	10	+90°C	dostępne w II kwartale		
61-602-2525-000	25 x 1"	10	+90°C	dostępne w II kwartale		

## 603

## Mufa skręcana



D GRUPA RABATOWA

indeks	wielkość	PN	Tmax	pakowanie		cena netto [zł]
61-603-0160-000	16	10	+90°C	10	200	14,28
61-603-0200-000	20	10	+90°C	5	150	22,81
61-603-1620-000	20 x 16	10	+90°C	dostępne w II kwartale		

## 604

## Kolano skręcane GZ



D GRUPA RABATOWA

indeks	wielkość	PN	Tmax	pakowanie		cena netto [zł]
61-604-1615-000	16 x 1/2"	10	+90°C	10	200	11,54
61-604-2015-000	20 x 1/2"	10	+90°C	5	150	15,75
61-604-2020-000	20 x 3/4"	10	+90°C	5	120	16,95

## 605

## Kolano skręcane GW



D GRUPA RABATOWA

indeks	wielkość	PN	Tmax	pakowanie		cena netto [zł]
61-605-1615-000	16 x 1/2"	10	+90°C	10	200	12,60
61-605-2015-000	20 x 1/2"	10	+90°C	5	150	16,53
61-605-2020-000	20 x 3/4"	10	+90°C	5	120	18,98

## 606

## Kolano skręcane



D GRUPA RABATOWA

indeks	wielkość	PN	Tmax	pakowanie		cena netto [zł]
61-606-0160-000	16	10	+90°C	10	200	14,90
61-606-0200-000	20	10	+90°C	5	125	21,13
61-606-2525-000	25	10	+90°C	dostępne w II kwartale		

**607**Kolano skręcane  
z mocowaniem GW

indeks	wielkość	PN	Tmax	pakowanie		cena netto [zł]
<b>61-607-1615-000</b>	16 x 1/2"	10	+90°C	10	120	<b>14,53</b>
<b>61-607-2015-000</b>	20 x 1/2"	10	+90°C	5	100	<b>20,75</b>
<b>61-607-2020-000</b>	20 x 3/4"	10	+90°C	dostępne w II kwartale		

**D** GRUPA RABATOWA**608**

Trójnik skręcany GZ



indeks	wielkość	PN	Tmax	pakowanie		cena netto [zł]
<b>61-608-1615-000</b>	16 x 1/2"	10	+90°C	10	120	<b>19,09</b>
<b>61-608-2015-000</b>	20 x 1/2"	10	+90°C	dostępne w II kwartale		
<b>61-608-2020-000</b>	20 x 3/4"	10	+90°C	dostępne w II kwartale		

**D** GRUPA RABATOWA**609**

Trójnik skręcany GW



indeks	wielkość	PN	Tmax	pakowanie		cena netto [zł]
<b>61-609-1615-000</b>	16 x 1/2"	10	+90°C	10	120	<b>20,59</b>
<b>61-609-2015-000</b>	20 x 1/2"	10	+90°C	dostępne w II kwartale		
<b>61-609-2020-000</b>	20 x 3/4"	10	+90°C	dostępne w II kwartale		

**D** GRUPA RABATOWA**60A**

Trójnik skręcany



indeks	wielkość	PN	Tmax	pakowanie		cena netto [zł]
<b>61-610-0160-000</b>	16	10	+90°C	10	120	<b>20,92</b>
<b>61-610-0200-000</b>	20	10	+90°C	5	80	<b>32,56</b>
<b>61-610-1620-000</b>	16 x 20 x 16	10	+90°C	dostępne w II kwartale		
<b>61-610-2016-000</b>	20 x 16 x 20	10	+90°C	5	100	<b>28,77</b>
<b>61-610-2520-000</b>	25 x 20 x 25	10	+90°C	dostępne w II kwartale		
<b>61-610-1616-000</b>	20 x 16 x 16	10	+90°C	dostępne w II kwartale		

**D** GRUPA RABATOWA

w ofercie w II kwartale

**U-P1**Uszczelka do złączek  
zaprasowywanych  
i skręcanych

indeks	wielkość	pakowanie		cena netto [zł]
<b>61-999-0160-000</b>	16	1	1	<b>0,37</b>
<b>61-999-0200-000</b>	20	1	1	<b>0,54</b>
<b>61-999-0250-000</b>	25	1	1	<b>1,07</b>
<b>61-999-0320-000</b>	32	1	1	<b>1,07</b>

**G** GRUPA RABATOWA**PHA-810**Hak podłogowy  
pojedynczy

indeks	wielkość	pakowanie		cena netto [zł]
<b>63-800-0810-000</b>	L-77	100	2500	<b>0,49</b>

**G** GRUPA RABATOWA**PHA-811**Hak podłogowy  
pojedynczy

indeks	wielkość	pakowanie		cena netto [zł]
<b>63-800-0811-000</b>	L-100	100	2500	<b>0,52</b>

**G** GRUPA RABATOWA**PHA-820**Hak podłogowy  
podwójny

indeks	wielkość	pakowanie		cena netto [zł]
<b>63-800-0820-000</b>	L-77	100	2500	<b>0,55</b>

**G** GRUPA RABATOWA

**PHA-821**Hak podłogowy  
podwójny

indeks	wielkość	pakowanie		cena netto [zł]
<b>63-800-0821-000</b>	L-100	100	500	<b>0,58</b>

**G** GRUPA RABATOWA**PHA-840**Folia izolacyjna  
przeciwwilgociowa  
do ogrzewania  
podłogowego

indeks	długość rolki	pakowanie		cena netto [zł za m <sup>2</sup> ]
<b>63-800-0840-000</b>	50 m <sup>2</sup>	1	1	<b>4,66</b>

**G** GRUPA RABATOWA**PHA-850**Korek do prób  
szczelności

indeks	wielkość	kolor	pakowanie		cena netto [zł]
<b>63-800-0850-000</b>	½"	czerwony	20	800	<b>1,60</b>

**G** GRUPA RABATOWA**PHA-851**Korek do prób  
szczelności

<b>63-800-0851-000</b>	½"	niebieski	20	800	<b>1,60</b>
------------------------	----	-----------	----	-----	-------------

**G** GRUPA RABATOWA**793**Gradownik do rur  
PERFEKT Pex lub Pert

indeks	wielkość	pakowanie		cena netto [zł]
<b>63-800-2160-000</b>	16	1	1	<b>44,13</b>
<b>63-800-2200-000</b>	20	1	1	<b>50,68</b>
<b>63-800-2250-000</b>	25	1	1	<b>65,40</b>
<b>63-800-2320-000</b>	32	1	1	<b>75,21</b>

**G** GRUPA RABATOWA**N-PRO1**Nożyce profesjonalne do  
cięcia rur PERFEKT SYSTEM  
Pex lub Pert

indeks	pakowanie		cena netto [zł]
<b>63-800-1014-000</b>	1	1	<b>189,24</b>

**G** GRUPA RABATOWA**790**Nożyce do cięcia rur  
PERFEKT SYSTEM  
Pex lub Pert

indeks	pakowanie		cena netto [zł]
<b>63-800-1015-000</b>	1	1	<b>75,70</b>

**G** GRUPA RABATOWA**791/0**Sprężyna do gięcia rur  
PERFEKT SYSTEM  
Pex lub Pert, zewnętrzne

indeks	wielkość	pakowanie		cena netto [zł]
<b>63-700-1600-001</b>	16	1	1	<b>43,11</b>
<b>63-700-2000-001</b>	20	1	1	<b>50,96</b>
<b>63-700-2500-001</b>	25	1	1	<b>82,30</b>
<b>63-700-3200-001</b>	32	1	1	<b>113,68</b>

**G** GRUPA RABATOWA

**792/0**

Sprężyna do gięcia rur  
PERFEKT SYSTEM  
Pex lub Pert, wewnętrzne



indeks	wielkość	pakowanie		cena netto [zł]
<b>63-700-1601-001</b>	16	1	1	<b>23,52</b>
<b>63-700-2001-001</b>	20	1	1	<b>35,26</b>
<b>63-700-2501-001</b>	25	1	1	<b>45,06</b>

**G** GRUPA RABATOWA

**RRP**

Rozwijak  
do rur PERT lub PEX



indeks	ilość rury w kręgu	rodzaj	pakowanie		cena netto [zł]
<b>63-200-0000-000</b>	500m i 600m	większy	1	1	<b>1335,00</b>

**X** GRUPA RABATOWA

**ACO103BT**

Zaciskarka  
bezprzewodowa  
Novopress ACO103  
+cęgi 16,20,25 - zestaw



indeks	pakowanie		cena netto [zł]
<b>63-100-0010-001</b>	1	1	<b>7100,00</b>

**X** GRUPA RABATOWA

**Cęgi zaciskowe**

Cęgi zaciskowe  
do zaciskarki ACO10BT



indeks	wielkość	numer	pakowanie		cena netto [zł]
<b>63-101-0004-160</b>	16	48066-50	1	1	<b>650,00</b>
<b>63-101-0004-200</b>	20	48068-50	1	1	<b>650,00</b>
<b>63-101-0004-250</b>	25	48069-50	1	1	<b>650,00</b>
<b>63-101-0004-320</b>	32	48070-50	1	1	<b>650,00</b>

**X** GRUPA RABATOWA

**82378**

Akumulator M12B4 4,0Ah  
do zaciskarki ACO103



indeks	pakowanie		cena netto [zł]
<b>63-100-0020-001</b>	1	1	<b>550,00</b>

**X** GRUPA RABATOWA

**Cęgi zaciskowe**

Cęgi zaciskowe profil  
U do złączek  
zaprasowywanych



indeks	wielkość	numer	pakowanie		cena netto [zł]
<b>63-000-0002-160</b>	16	570765	1	1	<b>676,50</b>
<b>63-000-0002-200</b>	20	570775	1	1	<b>676,50</b>
<b>63-000-0002-250</b>	25	570780	1	1	<b>676,50</b>
<b>63-000-0002-320</b>	32	570785	1	1	<b>676,50</b>
<b>63-000-0002-400</b>	40	570790	1	1	
<b>63-000-0002-500</b>	50	570795	1	1	
<b>63-000-0002-630</b>	63	572365	1	1	

**X** GRUPA RABATOWA

dostępność i warunki  
u Przedstawicieli Handlowych

**571013**

Zaciskarka  
bezprzewodowa  
Akku-Press



indeks	pakowanie		cena netto [zł]
<b>63-001-0002-000</b>	1	1	<b>6547,20</b>

**X** GRUPA RABATOWA

**578014**

Zaciskarka Mini-Press  
22V ACC Basic-Pack  
R220 L-Boxx



indeks

pakowanie

cena netto [zł]

**63-001-0016-000**

1 1

**7436,00**

(X) GRUPA RABATOWA

**572111**

Zaciskarka przewodowa  
Power-Press SE



indeks

pakowanie

cena netto [zł]

**63-001-0003-000**

1 1

**4092,00**

(X) GRUPA RABATOWA

**577010**

Zaciskarka przewodowa  
Power-Press



indeks

pakowanie

cena netto [zł]

**63-001-0018-000**

1 1

**5800,00**

(X) GRUPA RABATOWA

**577011**

Zaciskarka przewodowa  
Power-Press



indeks

pakowanie

cena netto [zł]

**63-001-0004-000**

1 1

**5053,40**

(X) GRUPA RABATOWA

**574000**

Zaciskarka ręczna  
Eco-Press



indeks

pakowanie

cena netto [zł]

**63-001-0005-000**

1 1

**671,55**

(X) GRUPA RABATOWA

**571555**

Akumulator Li-Ion do  
zaciskarki Akku-Press,  
14.4 V, 3.0 Ah



indeks

pakowanie

cena netto [zł]

**63-001-0008-000**

1 1

**1372,80**

(X) GRUPA RABATOWA

**Cęgi zaciskowe mini U**

Cęgi zaciskowe profil  
U do złączek  
zaprasowywanych



indeks

wielkość

numer

pakowanie

cena netto [zł]

**63-000-0001-160**

16

578374

1 1

**686,40****63-000-0001-200**

20

578378

1 1

**686,40****63-000-0001-250**

25

578380

1 1

**686,40****63-000-0001-320**

32

578382

1 1

**800,80**

(X) GRUPA RABATOWA

**571014**

Zaciskarka bezprzewodowa  
Akku-Press ACC



indeks

pakowanie

cena netto [zł]

**63-001-0011-000**

1 1

**7207,20**

(X) GRUPA RABATOWA

**578012**Zaciskarka  
bezprzewodowa  
Mini-Press ACC

indeks

pakowanie  
cena  
netto [zł]**63-001-0017-000**1 1 **6749,60** GRUPA RABATOWA**578015**Zaciskarka  
bezprzewodowa  
Mini-Press S 22V ACC

indeks

pakowanie  
cena  
netto [zł]**63-001-0013-001**1 1 **7436,00** GRUPA RABATOWA**578010**Zaciskarka  
bezprzewodowa  
Mini-Press 22V ACC

indeks

pakowanie  
cena  
netto [zł]**63-001-0006-100**1 1 **7436,00** GRUPA RABATOWA**571545**Akumulator Li-Ion  
do zaciskarki  
**Mini-Press 578012,**  
14,4 V, 1,5 Ah

indeks

pakowanie  
cena  
netto [zł]**63-001-0008-003**1 1 **972,40** GRUPA RABATOWA**571571**Akumulator Li-Ion  
do zaciskarek  
**Mini-Press 578010 i 578015,**  
21,6 V, 2,5 Ah

indeks

pakowanie  
cena  
netto [zł]**63-001-0008-001**1 1 **1601,60** GRUPA RABATOWA**Posiadamy w ofercie narzędzia dostępne w akcjach promocyjnych  
- szczegóły dostępne u przedstawicieli handlowych.****JL1303**Klucz do rur ze  
szczękami płaskimi

indeks

wielkość

pakowanie  
cena  
netto [zł]**90-000-0000-089**

1"

1 1 **65,00** GRUPA RABATOWA**Szczypce uniwersalne  
-kombinerki**

indeks

wielkość

pakowanie  
cena  
netto [zł]**90-000-0000-083**

180 mm

1 1 **27,00** GRUPA RABATOWA



### Szczypce wydłużone proste

	indeks	wielkość	pakowanie		cena netto [zł]
					
	<b>90-000-0000-085</b>	200 mm	1	1	<b>27,00</b>

GRUPA RABATOWA

### JL1306



Klucz do rur typ S

	indeks	wielkość	pakowanie		cena netto [zł]
					
	<b>90-000-0000-090</b>	1"	1	1	<b>65,00</b>

GRUPA RABATOWA

### JL1309

Klucz nastawny do rur typu Stillson

	indeks		pakowanie		cena netto [zł]
					
	<b>90-000-0000-093</b>		1	1	<b>70,00</b>

GRUPA RABATOWA

### NWDS-01



Nasadka wielostopniowa do śrubunków

	indeks		pakowanie		cena netto [zł]
					
	<b>90-000-0000-207</b>		1	1	<b>60,00</b>

GRUPA RABATOWA

### UGF1006-PP

Klucz nastawny

	indeks	wielkość	pakowanie		cena netto [zł]
					
	<b>90-000-0001-078</b>	6"	1	1	<b>37,00</b>
	<b>90-000-0001-079</b>	10"	1	1	<b>65,00</b>

GRUPA RABATOWA

### GL9068



Kamera inspekcyjna do rur

	indeks		pakowanie		cena netto [zł]
					
	<b>90-000-0001-080</b>		1	1	<b>850,00</b>

GRUPA RABATOWA

### GT4863

Kabel do kamery inspekcyjnej

	indeks	długość	pakowanie		cena netto [zł]
					
	<b>90-000-0001-089</b>	5 m	1	1	<b>400,00</b>

GRUPA RABATOWA

# PERFEXIM

CENNIK ARMATURA 2024



PERFEKT<sup>2</sup> SYSTEM

- **Niezawodne rozwiązanie w branży HVAC**
- **Zgodna z normą EN12735:1 Miedź i stopy miedzi**
- **Europejski producent**
- **Ochrona zdrowia**

# RURA MIEDZIANA

72-74



## 505

Rura miedziana twarda stan R290

 GRUPA RABATOWA

indeks	wielkość	sztangi 5 m [szt / wiązka m]		cena netto [zł]
<b>70-505-1210-030</b>	12 x 1,0	5	750	<b>z dnia</b>
<b>70-505-1510-030</b>	15 x 1,0	5	500	<b>z dnia</b>
<b>70-505-1810-030</b>	18 x 1,0	5	500	<b>z dnia</b>
<b>70-505-2210-030</b>	22 x 1,0	5	500	<b>z dnia</b>
<b>70-505-2810-030</b>	28 x 1,0	5	500	<b>z dnia</b>
<b>70-505-2815-530</b>	28 x 1,5	5	500	<b>z dnia</b>
<b>70-505-3510-030</b>	35 x 1,0	5	5	<b>z dnia</b>
<b>70-505-3515-530</b>	35 x 1,5	5	5	<b>z dnia</b>
<b>70-505-4215-530</b>	42 x 1,5	5	5	<b>z dnia</b>
<b>70-505-5420-030</b>	54 x 2,0	5	5	<b>z dnia</b>

## 501

Rura miedziana miękka stan R220

 GRUPA RABATOWA

indeks	wielkość	długość [mb]	cena netto [zł]
<b>70-501-1210-030</b>	12 x 1,0	50	<b>z dnia</b>
<b>70-501-1510-030</b>	15 x 1,0	50	<b>z dnia</b>
<b>70-501-1810-030</b>	18 x 1,0	50	<b>z dnia</b>
<b>70-501-2210-030</b>	22 x 1,0	50	<b>z dnia</b>

## 508

CLIMAPLUS rura miedziana miękka R220, w otulinie m.in. do klimatyzacji, gazów chłodniczych

 GRUPA RABATOWA

indeks	wielkość	grubość otuliny [mm]	długość [mb]	cena netto [zł]
<b>70-508-1408-030</b>	¼" x 0,7	6	25	<b>z dnia</b>
<b>70-508-3808-030</b>	¾" x 0,7	7	25	<b>z dnia</b>
<b>70-508-1208-030</b>	½" x 0,7	9	25	<b>z dnia</b>
<b>70-508-5808-030</b>	⅝" x 0,7	9	25	<b>z dnia</b>
<b>70-508-1408-035</b>	¼" x 0,7	6	50	<b>z dnia</b>
<b>70-508-3808-035</b>	¾" x 0,7	7	50	<b>z dnia</b>
<b>70-508-1208-035</b>	½" x 0,7	9	50	<b>z dnia</b>
<b>70-508-5808-035</b>	⅝" x 0,7	9	50	<b>z dnia</b>

## 503

CLIMATUB rura miedziana miękka R220, m.in. do klimatyzacji, celów medycznych

 GRUPA RABATOWA

indeks	wielkość	długość [mb]	cena netto [zł/mb]
<b>70-503-0810-030</b>	8 x 1,0	25	<b>z dnia</b>
<b>70-503-1210-030</b>	12 x 1,0	25	<b>z dnia</b>
<b>70-503-1410-030</b>	14 x 1,0	25	<b>z dnia</b>
<b>70-503-1810-030</b>	18 x 1,0	25	<b>z dnia</b>
<b>70-503-2210-030</b>	22 x 1,0	25	<b>z dnia</b>
<b>70-503-1408-030</b>	¼" x 0,8	15	<b>z dnia</b>
<b>70-503-5168-030</b>	⅝" x 0,8	15	<b>z dnia</b>
<b>70-503-3808-030</b>	¾" x 0,8	15	<b>z dnia</b>
<b>70-503-1208-030</b>	½" x 0,8	15	<b>z dnia</b>
<b>70-503-5808-030</b>	⅝" x 0,8	15	<b>z dnia</b>
<b>70-503-5810-030</b>	⅝" x 1,0	15	<b>z dnia</b>
<b>70-503-3408-030</b>	¾" x 0,8	15	<b>z dnia</b>
<b>70-503-3410-030</b>	¾" x 1,0	15	<b>z dnia</b>
<b>70-503-7810-030</b>	⅞" x 1,0	15	<b>z dnia</b>

507

CLIMATUB rura miedzian  
twarda R290 m.in.  
do klimatyzacji



X GRUPA RABATOWA

indeks	wielkość	długość [mb]		cena netto [zł/mb]
<b>70-507-0810-030</b>	8 x 1.0	5	50	<b>z dnia</b>
<b>70-507-1010-030</b>	10 x 1.0	5	50	<b>z dnia</b>
<b>70-507-1210-030</b>	12 x 1.0	5	50	<b>z dnia</b>
<b>70-507-1510-030</b>	15 x 1.0	5	50	<b>z dnia</b>
<b>70-507-1810-030</b>	18 x 1.0	5	50	<b>z dnia</b>
<b>70-507-2210-030</b>	22 x 1.0	5	50	<b>z dnia</b>
<b>70-507-2810-030</b>	28 x 1.0	5	50	<b>z dnia</b>
<b>70-507-2815-030</b>	28 x 1.5	5	50	<b>z dnia</b>
<b>70-507-3510-030</b>	35 x 1.0	5	50	<b>z dnia</b>
<b>70-507-3515-030</b>	35 x 1.5	5	50	<b>z dnia</b>
<b>70-507-4215-030</b>	42 x 1.5	5	50	<b>z dnia</b>
<b>70-507-5415-030</b>	54 x 1.5	5	50	<b>z dnia</b>
<b>70-507-5420-030</b>	54 x 2.0	5	50	<b>z dnia</b>
<b>70-507-3808-030</b>	¾" x 0.8	5	50	<b>z dnia</b>
<b>70-507-1208-030</b>	½" x 0.8	5	50	<b>z dnia</b>
<b>70-507-5808-030</b>	⅝" x 0.8	5	50	<b>z dnia</b>
<b>70-507-3408-030</b>	¾" x 0.8	5	50	<b>z dnia</b>
<b>70-507-3410-030</b>	¾" x 1.0	5	50	<b>z dnia</b>
<b>70-507-7810-030</b>	⅞" x 1.0	5	50	<b>z dnia</b>
<b>70-507-2510-030</b>	1" x 1.0	5	50	<b>z dnia</b>
<b>70-507-1181-030</b>	1 ⅛" x 1.0	5	50	<b>z dnia</b>
<b>70-507-1381-030</b>	1 ⅜" x 1.25	5	50	<b>z dnia</b>
<b>70-507-1581-030</b>	1 ⅝" x 1.25	5	50	<b>z dnia</b>
<b>70-507-2181-030</b>	2 ⅛" x 1.25	5	50	<b>z dnia</b>
<b>70-507-2186-030</b>	2 ⅛" x 1.65	5	50	<b>z dnia</b>
<b>70-507-2581-030</b>	2 ⅝" x 1.65	5	50	<b>z dnia</b>
<b>70-507-2582-030</b>	2 ⅝" x 2.0	5	50	<b>z dnia</b>
<b>70-507-3181-030</b>	3 ⅛" x 1.65	5	50	<b>z dnia</b>



Ciepło i komfort w domu

# PERFEXIM

CENNIK ARMATURA 2024



PERFEKT<sup>2</sup> SYSTEM

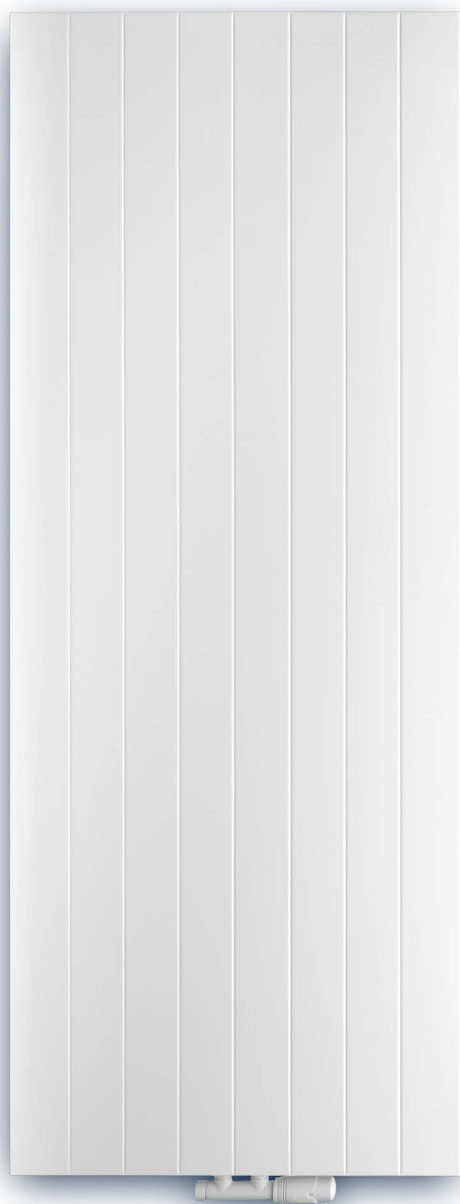

Grzejniki Pionowe **Style Line** powstały z myślą o Klientach ceniących sobie zarówno funkcjonalność jak i nowoczesny design. Poza swoją niezawodną funkcją grzewczą mogą posłużyć również jako modny element wystroju wnętrza, nadając im unikalny charakter. Są dostępne w szerokiej gamie kolorów z palety RAL.

## GRZEJNIKI PŁYTOWE I ALUMINIOWE 75-80

Grzejniki płytowe C i V	76
Grzejniki aluminiowe	78
Osprzęt grzejników aluminiowych	78
Główce termostatyczne	78
Osprzęt grzejników stalowych	80

		11C					21C					22C					33C				
wysokość [mm]		300	400	500	600	900	300	400	500	600	900	300	400	500	600	900	300	400	500	600	900
wykładnik n		1,2842	1,2850	1,2857	1,2865	1,2957	1,2877	1,2914	1,2950	1,2987	1,3250	1,2890	1,2967	1,3045	1,3122	1,3266	1,2999	1,3016	1,3033	1,3050	1,3481
długość [mm]	parametry $t_1/t_2/t_3$																				
400	75/65/20°C	199	252	303	354	502	290	366	438	508	706	368	473	572	669	905	508	646	777	902	1243
	55/45/20°C	103	131	157	183	259	150	189	226	261	359	190	244	294	342	459	262	332	399	463	624
	CENA	<b>307</b>	<b>334</b>	<b>349</b>	<b>413</b>	<b>532</b>	<b>404</b>	<b>459</b>	<b>487</b>	<b>536</b>	<b>650</b>	<b>426</b>	<b>491</b>	<b>514</b>	<b>552</b>	<b>700</b>	<b>674</b>	<b>741</b>	<b>781</b>	<b>800</b>	<b>1128</b>
500	75/65/20°C	248	315	379	442	628	362	457	547	635	882	460	591	715	836	1131	636	808	971	1127	1554
	55/45/20°C	129	163	196	229	324	188	236	283	327	449	238	305	367	428	574	327	416	499	579	781
	CENA	<b>342</b>	<b>366</b>	<b>375</b>	<b>421</b>	<b>562</b>	<b>435</b>	<b>498</b>	<b>534</b>	<b>571</b>	<b>729</b>	<b>461</b>	<b>534</b>	<b>564</b>	<b>591</b>	<b>789</b>	<b>740</b>	<b>816</b>	<b>858</b>	<b>884</b>	<b>1260</b>
600	75/65/20°C	298	378	455	530	753	434	548	657	761	1059	552	710	858	1004	1357	763	970	1166	1352	1865
	55/45/20°C	155	196	236	275	388	225	284	339	392	538	286	366	440	513	689	393	499	599	694	937
	CENA	<b>367</b>	<b>396</b>	<b>408</b>	<b>435</b>	<b>575</b>	<b>461</b>	<b>526</b>	<b>562</b>	<b>603</b>	<b>771</b>	<b>487</b>	<b>571</b>	<b>607</b>	<b>648</b>	<b>864</b>	<b>816</b>	<b>883</b>	<b>914</b>	<b>974</b>	<b>1349</b>
700	75/65/20°C	348	441	531	619	879	507	640	766	888	1235	644	828	1000	1171	1583	890	1131	1360	1578	2176
	55/45/20°C	181	229	275	321	453	263	331	396	458	628	333	427	514	599	804	458	582	699	810	1093
	CENA	<b>396</b>	<b>422</b>	<b>435</b>	<b>454</b>	<b>617</b>	<b>505</b>	<b>575</b>	<b>611</b>	<b>655</b>	<b>857</b>	<b>534</b>	<b>617</b>	<b>652</b>	<b>704</b>	<b>976</b>	<b>890</b>	<b>970</b>	<b>1011</b>	<b>1073</b>	<b>1503</b>
800	75/65/20°C	398	504	606	707	1004	579	731	876	1015	1412	736	946	1143	1338	1810	1017	1293	1554	1803	2486
	55/45/20°C	206	261	314	367	518	300	378	452	523	718	381	488	587	685	919	523	665	799	926	1249
	CENA	<b>422</b>	<b>450</b>	<b>461</b>	<b>472</b>	<b>655</b>	<b>543</b>	<b>617</b>	<b>653</b>	<b>713</b>	<b>930</b>	<b>581</b>	<b>657</b>	<b>689</b>	<b>741</b>	<b>1080</b>	<b>942</b>	<b>1037</b>	<b>1091</b>	<b>1146</b>	<b>1654</b>
900	75/65/20°C	447	567	682	796	1130	652	823	985	1142	1588	828	1065	1286	1506	2036	1144	1454	1749	2029	2797
	55/45/20°C	232	294	354	412	583	338	425	509	588	807	429	549	661	770	1034	589	748	899	1042	1405
	CENA	<b>449</b>	<b>487</b>	<b>494</b>	<b>508</b>	<b>706</b>	<b>595</b>	<b>672</b>	<b>706</b>	<b>770</b>	<b>1021</b>	<b>635</b>	<b>721</b>	<b>755</b>	<b>803</b>	<b>1197</b>	<b>1022</b>	<b>1129</b>	<b>1191</b>	<b>1245</b>	<b>1802</b>
1000	75/65/20°C	497	630	758	884	1255	724	914	1095	1269	1765	920	1183	1429	1673	2262	1271	1616	1943	2254	3108
	55/45/20°C	258	327	393	458	647	375	473	565	654	897	476	610	734	856	1149	654	831	998	1157	1561
	CENA	<b>477</b>	<b>515</b>	<b>535</b>	<b>554</b>	<b>760</b>	<b>626</b>	<b>703</b>	<b>736</b>	<b>785</b>	<b>1107</b>	<b>690</b>	<b>761</b>	<b>774</b>	<b>809</b>	<b>1284</b>	<b>1098</b>	<b>1216</b>	<b>1284</b>	<b>1326</b>	<b>1956</b>
1100	75/65/20°C	547	693	834	972	1381	796	1006	1204	1396	1941	1012	1301	1572	1840	2488	1398	1778	2137	2479	3419
	55/45/20°C	284	360	432	504	712	413	520	622	719	987	524	671	807	941	1264	720	914	1098	1273	1717
	CENA	<b>495</b>	<b>551</b>	<b>582</b>	<b>603</b>	<b>807</b>	<b>667</b>	<b>767</b>	<b>823</b>	<b>884</b>	<b>1188</b>	<b>735</b>	<b>829</b>	<b>861</b>	<b>923</b>	<b>1411</b>	<b>1172</b>	<b>1298</b>	<b>1373</b>	<b>1443</b>	<b>2119</b>
1200	75/65/20°C	596	756	909	1061	1506	869	1097	1314	1523	2118	1104	1419	1715	2007	2714	1525	1939	2332	2705	3730
	55/45/20°C	309	392	472	550	777	450	567	678	784	1076	571	732	881	1027	1378	785	997	1198	1389	1873
	CENA	<b>524</b>	<b>585</b>	<b>617</b>	<b>627</b>	<b>857</b>	<b>704</b>	<b>818</b>	<b>883</b>	<b>946</b>	<b>1274</b>	<b>774</b>	<b>898</b>	<b>952</b>	<b>985</b>	<b>1526</b>	<b>1245</b>	<b>1379</b>	<b>1462</b>	<b>1533</b>	<b>2273</b>
1300	75/65/20°C	646	819	985	1149	1632	941	1188	1423	1650	2294	1196	1538	1858	2175	2941	1652	2101	2526	2930	4040
	55/45/20°C	335	425	511	596	842	488	614	735	850	1166	619	793	954	1112	1493	851	1081	1298	1504	2029
	CENA	<b>541</b>	<b>622</b>	<b>674</b>	<b>694</b>	<b>938</b>	<b>749</b>	<b>868</b>	<b>936</b>	<b>1031</b>	<b>1355</b>	<b>843</b>	<b>1007</b>	<b>1095</b>	<b>1164</b>	<b>1679</b>	<b>1350</b>	<b>1535</b>	<b>1660</b>	<b>1738</b>	<b>2523</b>
1400	75/65/20°C	696	882	1061	1238	1757	1014	1280	1533	1777	2471	1288	1656	2001	2342	3167	1779	2262	2720	3156	4351
	55/45/20°C	361	458	550	641	906	525	662	791	915	1256	667	854	1028	1198	1608	916	1164	1398	1620	2185
	CENA	<b>553</b>	<b>637</b>	<b>700</b>	<b>717</b>	<b>961</b>	<b>771</b>	<b>898</b>	<b>971</b>	<b>1069</b>	<b>1405</b>	<b>877</b>	<b>1041</b>	<b>1128</b>	<b>1216</b>	<b>1710</b>	<b>1389</b>	<b>1577</b>	<b>1703</b>	<b>1773</b>	<b>2580</b>
1600	75/65/20°C	795	1008	1213	1414	2008	1158	1463	1752	2030	2824	1472	1893	2287	2677	3619	2034	2586	3109	3606	4973
	55/45/20°C	413	523	629	733	1036	600	756	904	1046	1435	762	976	1174	1369	1838	1047	1330	1598	1852	2498
	CENA	<b>607</b>	<b>700</b>	<b>761</b>	<b>811</b>	<b>1065</b>	<b>854</b>	<b>996</b>	<b>1078</b>	<b>1180</b>	<b>1565</b>	<b>991</b>	<b>1167</b>	<b>1257</b>	<b>1379</b>	<b>1924</b>	<b>1533</b>	<b>1770</b>	<b>1938</b>	<b>2038</b>	<b>2861</b>
1800	75/65/20°C	895	1134	1364	1591	2259	1303	1645	1971	2284	3177	1656	2129	2573	3011	4072	2288	2909	3497	4057	5594
	55/45/20°C	464	588	707	825	1165	675	851	1017	1177	1615	857	1098	1321	1540	2068	1178	1496	1797	2083	2810
	CENA	<b>659</b>	<b>771</b>	<b>853</b>	<b>901</b>	<b>1178</b>	<b>932</b>	<b>1097</b>	<b>1200</b>	<b>1330</b>	<b>1745</b>	<b>1091</b>	<b>1298</b>	<b>1405</b>	<b>1580</b>	<b>2147</b>	<b>1687</b>	<b>1956</b>	<b>2148</b>	<b>2273</b>	<b>3150</b>
2000	75/65/20°C	994	1260	1516	1768	2510	1448	1828	2190	2538	3530	1840	2366	2858	3346	4524	2542	3232	3886	4508	6216
	55/45/20°C	516	654	786	916	1295	750	945	1130	1307	1794	952	1220	1468	1711	2297	1309	1662	1997	2315	3122
	CENA	<b>716</b>	<b>837</b>	<b>923</b>	<b>976</b>	<b>1339</b>	<b>1011</b>	<b>1203</b>	<b>1323</b>	<b>1456</b>	<b>1894</b>	<b>1187</b>	<b>1437</b>	<b>1577</b>	<b>1713</b>	<b>2325</b>	<b>1819</b>	<b>2123</b>	<b>2346</b>	<b>2533</b>	<b>3410</b>
2200	75/65/20°C	1093	1386	1667	1945	2761	1593	2011	2409	2792	3883	2024	2602	3144	3680	4976	2796	3555	4275	4959	6838
	55/45/20°C	567	719	865	1008	1424	825	1040	1243	1438	1973	1048	1342	1615	1883	2527	1439	1829	2197	2546	3434
	CENA	<b>774</b>	<b>892</b>	<b>976</b>	<b>1108</b>	<b>1472</b>	<b>1088</b>	<b>1290</b>	<b>1415</b>	<b>1612</b>	<b>2181</b>	<b>1330</b>	<b>1610</b>	<b>1763</b>	<b>1894</b>	<b>2661</b>	<b>2020</b>	<b>2336</b>	<b>2561</b>	<b>2886</b>	<b>3769</b>
2400	75/65/20°C	1193	1512	1819	2122	3012	1738	2194	2628	3046	4236	2208	2839	3430	4015	5429	3050	3878	4663	5410	7459
	55/45/20°C	619	784	943	1100	1554	900	1134	1356	1569	2153	1143	1464	1762	2054	2757	1570	1995	2396	2777	3746
	CENA	<b>881</b>	<b>1027</b>	<b>1136</b>	<b>1180</b>	<b>1625</b>	<b>1220</b>	<b>1425</b>	<b>1548</b>	<b>1725</b>	<b>2291</b>	<b>1415</b>	<b>1739</b>	<b>1932</b>	<b>2046</b>	<b>2794</b>	<b>2129</b>	<b>2483</b>	<b>2741</b>	<b>3101</b>	<b>3922</b>
2600	75/65/20°C	1292	1638	1971	2298	3263	1882	2377	2847	3299	4589	2392	3075	3716	4349	5881	3305	4202	5052	5860	8081
	55/45/20°C	671	850	1022	1191	1683	975	1229	1469	1699	2332	1238	1586	1908	2225	2986	1701	2161	2596	3009	4059
	CENA	<b>921</b>	<b>1065</b>	<b>1169</b>	<b>1268</b>	<b>1793</b>	<b>1267</b>	<b>1510</b>	<b>1667</b>	<b>1829</b>	<b>2496</b>	<b>1463</b>	<b>1833</b>	<b>2063</b>	<b>2287</b>	<b>3029</b>	<b>2255</b>	<b>2644</b>	<b>2930</b>	<b>3299</b>	<b>4203</b>
2800	75/65/20°C	1392	1764	2122	2475	3514	2027	2560	3066	3553	4942	2576	3312	4002	4684	6334	3559	4525	5440	6311	8702
	55/45/20°C	722	915	1100	1283	1813	1050	1323	1582	1830	2512	1333	1708	2055	2396	3216	1832	2327	2796	3240	4371
	CENA	<b>1013</b>	<b>1164</b>	<b>1267</b>	<b>1360</b>	<b>1928</b>	<b>1389</b>	<b></b>													

		11V					21V					22V					33V				
wysokość [mm]		300	400	500	600	900	300	400	500	600	900	300	400	500	600	900	300	400	500	600	900
wat/m 70/50/20°C		373	473	569	663	940	543	685	820	950	1313	690	886	1068	1248	1682	951	1209	1453	1685	2301
wykładnik n		1,2842	1,2850	1,2857	1,2865	1,2957	1,2877	1,2914	1,2950	1,2987	1,3250	1,2890	1,2967	1,3045	1,3122	1,3266	1,2999	1,3016	1,3033	1,3050	1,3481
dlugość [mm]	parametry $\epsilon_r/\epsilon_i$																				
400	75/65/20°C	199	252	303	354	502	290	366	438	508	706	368	473	572	669	905	508	646	777	902	1243
	55/45/20°C	103	131	157	183	259	150	189	226	261	359	190	244	294	342	459	262	332	399	463	624
	CENA	<b>487</b>	<b>520</b>	<b>532</b>	<b>549</b>	<b>650</b>	<b>601</b>	<b>633</b>	<b>653</b>	<b>694</b>	<b>858</b>	<b>635</b>	<b>677</b>	<b>694</b>	<b>754</b>	<b>909</b>	<b>890</b>	<b>979</b>	<b>1041</b>	<b>1108</b>	<b>1318</b>
500	75/65/20°C	248	315	379	442	628	362	457	547	635	882	460	591	715	836	1131	636	808	971	1127	1554
	55/45/20°C	129	163	196	229	324	188	236	283	327	449	238	305	367	428	574	327	416	499	579	781
	CENA	<b>507</b>	<b>541</b>	<b>554</b>	<b>565</b>	<b>684</b>	<b>648</b>	<b>679</b>	<b>700</b>	<b>734</b>	<b>921</b>	<b>672</b>	<b>716</b>	<b>735</b>	<b>771</b>	<b>991</b>	<b>956</b>	<b>1037</b>	<b>1088</b>	<b>1164</b>	<b>1407</b>
600	75/65/20°C	298	378	455	530	753	434	548	657	761	1059	552	710	858	1004	1357	763	970	1166	1352	1865
	55/45/20°C	155	196	236	275	388	225	284	339	392	538	286	366	440	513	689	393	499	599	694	937
	CENA	<b>528</b>	<b>562</b>	<b>575</b>	<b>584</b>	<b>717</b>	<b>674</b>	<b>711</b>	<b>735</b>	<b>760</b>	<b>956</b>	<b>710</b>	<b>761</b>	<b>785</b>	<b>821</b>	<b>1055</b>	<b>993</b>	<b>1086</b>	<b>1144</b>	<b>1229</b>	<b>1486</b>
700	75/65/20°C	348	441	531	619	879	507	640	766	888	1235	644	828	1000	1171	1583	890	1131	1360	1578	2176
	55/45/20°C	181	229	275	321	453	263	331	396	458	628	333	427	514	599	804	458	582	699	810	1093
	CENA	<b>564</b>	<b>602</b>	<b>613</b>	<b>624</b>	<b>770</b>	<b>714</b>	<b>749</b>	<b>770</b>	<b>843</b>	<b>1048</b>	<b>744</b>	<b>809</b>	<b>839</b>	<b>878</b>	<b>1187</b>	<b>1069</b>	<b>1166</b>	<b>1229</b>	<b>1295</b>	<b>1642</b>
800	75/65/20°C	398	504	606	707	1004	579	731	876	1015	1412	736	946	1143	1338	1810	1017	1293	1554	1803	2486
	55/45/20°C	206	261	314	367	518	300	378	452	523	718	381	488	587	685	919	523	665	799	926	1249
	CENA	<b>617</b>	<b>626</b>	<b>637</b>	<b>650</b>	<b>820</b>	<b>749</b>	<b>789</b>	<b>812</b>	<b>901</b>	<b>1164</b>	<b>771</b>	<b>853</b>	<b>898</b>	<b>936</b>	<b>1300</b>	<b>1141</b>	<b>1221</b>	<b>1267</b>	<b>1354</b>	<b>1793</b>
900	75/65/20°C	447	567	682	796	1130	652	823	985	1142	1588	828	1065	1286	1506	2036	1144	1454	1749	2029	2797
	55/45/20°C	232	294	354	412	583	338	425	509	588	807	429	549	661	770	1034	589	748	899	1042	1405
	CENA	<b>637</b>	<b>662</b>	<b>673</b>	<b>694</b>	<b>878</b>	<b>788</b>	<b>837</b>	<b>869</b>	<b>959</b>	<b>1256</b>	<b>837</b>	<b>911</b>	<b>952</b>	<b>999</b>	<b>1463</b>	<b>1227</b>	<b>1318</b>	<b>1368</b>	<b>1463</b>	<b>1948</b>
1000	75/65/20°C	497	630	758	884	1255	724	914	1095	1269	1765	920	1183	1429	1673	2262	1271	1616	1943	2254	3108
	55/45/20°C	258	327	393	458	647	375	473	565	654	897	476	610	734	856	1149	654	831	998	1157	1561
	CENA	<b>666</b>	<b>696</b>	<b>703</b>	<b>711</b>	<b>930</b>	<b>822</b>	<b>879</b>	<b>914</b>	<b>1003</b>	<b>1350</b>	<b>883</b>	<b>954</b>	<b>991</b>	<b>1022</b>	<b>1558</b>	<b>1299</b>	<b>1401</b>	<b>1463</b>	<b>1561</b>	<b>2097</b>
1100	75/65/20°C	547	693	834	972	1381	796	1006	1204	1396	1941	1012	1301	1572	1840	2488	1398	1778	2137	2479	3419
	55/45/20°C	284	360	432	504	712	413	520	622	719	987	524	671	807	941	1264	720	914	1098	1273	1717
	CENA	<b>690</b>	<b>735</b>	<b>749</b>	<b>766</b>	<b>977</b>	<b>862</b>	<b>942</b>	<b>999</b>	<b>1073</b>	<b>1431</b>	<b>930</b>	<b>1031</b>	<b>1095</b>	<b>1117</b>	<b>1670</b>	<b>1389</b>	<b>1498</b>	<b>1564</b>	<b>1680</b>	<b>2246</b>
1200	75/65/20°C	596	756	909	1061	1506	869	1097	1314	1523	2118	1104	1419	1715	2007	2714	1525	1939	2332	2705	3730
	55/45/20°C	309	392	472	550	777	450	567	678	784	1076	571	732	881	1027	1378	785	997	1198	1389	1873
	CENA	<b>721</b>	<b>769</b>	<b>781</b>	<b>791</b>	<b>1025</b>	<b>908</b>	<b>993</b>	<b>1060</b>	<b>1140</b>	<b>1514</b>	<b>976</b>	<b>1095</b>	<b>1170</b>	<b>1225</b>	<b>1713</b>	<b>1463</b>	<b>1586</b>	<b>1667</b>	<b>1783</b>	<b>2408</b>
1300	75/65/20°C	646	819	985	1149	1632	941	1188	1423	1650	2294	1196	1538	1858	2175	2941	1652	2101	2526	2930	4040
	55/45/20°C	335	425	511	596	842	488	614	735	850	1166	619	793	954	1112	1493	851	1081	1298	1504	2029
	CENA	<b>766</b>	<b>820</b>	<b>839</b>	<b>850</b>	<b>1081</b>	<b>959</b>	<b>1052</b>	<b>1124</b>	<b>1217</b>	<b>1594</b>	<b>1038</b>	<b>1187</b>	<b>1288</b>	<b>1332</b>	<b>1872</b>	<b>1581</b>	<b>1762</b>	<b>1891</b>	<b>2157</b>	<b>2671</b>
1400	75/65/20°C	696	882	1061	1238	1757	1014	1280	1533	1777	2471	1288	1656	2001	2342	3167	1779	2262	2720	3156	4351
	55/45/20°C	361	458	550	641	906	525	662	791	915	1256	667	854	1028	1198	1608	916	1164	1398	1620	2185
	CENA	<b>791</b>	<b>853</b>	<b>873</b>	<b>884</b>	<b>1112</b>	<b>985</b>	<b>1081</b>	<b>1155</b>	<b>1258</b>	<b>1631</b>	<b>1065</b>	<b>1221</b>	<b>1329</b>	<b>1375</b>	<b>1907</b>	<b>1612</b>	<b>1812</b>	<b>1958</b>	<b>2198</b>	<b>2705</b>
1600	75/65/20°C	795	1008	1213	1414	2008	1158	1463	1752	2030	2824	1472	1893	2287	2677	3619	2034	2586	3109	3606	4973
	55/45/20°C	413	523	629	733	1036	600	756	904	1046	1435	762	976	1174	1369	1838	1047	1330	1598	1852	2498
	CENA	<b>861</b>	<b>926</b>	<b>954</b>	<b>992</b>	<b>1208</b>	<b>1071</b>	<b>1180</b>	<b>1267</b>	<b>1389</b>	<b>1811</b>	<b>1157</b>	<b>1360</b>	<b>1507</b>	<b>1568</b>	<b>2129</b>	<b>1769</b>	<b>2006</b>	<b>2185</b>	<b>2428</b>	<b>2982</b>
1800	75/65/20°C	895	1134	1364	1591	2259	1303	1645	1971	2284	3177	1656	2129	2573	3011	4072	2288	2909	3497	4057	5594
	55/45/20°C	464	588	707	825	1165	675	851	1017	1177	1615	857	1098	1321	1540	2068	1178	1496	1797	2083	2810
	CENA	<b>936</b>	<b>1005</b>	<b>1037</b>	<b>1078</b>	<b>1319</b>	<b>1159</b>	<b>1288</b>	<b>1389</b>	<b>1528</b>	<b>1978</b>	<b>1250</b>	<b>1477</b>	<b>1647</b>	<b>1763</b>	<b>2323</b>	<b>1927</b>	<b>2184</b>	<b>2374</b>	<b>2681</b>	<b>3275</b>
2000	75/65/20°C	994	1260	1516	1768	2510	1448	1828	2190	2538	3530	1840	2366	2858	3346	4524	2542	3232	3886	4508	6216
	55/45/20°C	516	654	786	916	1295	750	945	1130	1307	1794	952	1220	1468	1711	2297	1309	1662	1997	2315	3122
	CENA	<b>997</b>	<b>1077</b>	<b>1115</b>	<b>1159</b>	<b>1477</b>	<b>1238</b>	<b>1385</b>	<b>1506</b>	<b>1680</b>	<b>2181</b>	<b>1344</b>	<b>1596</b>	<b>1785</b>	<b>1943</b>	<b>2539</b>	<b>2075</b>	<b>2365</b>	<b>2583</b>	<b>2907</b>	<b>3550</b>
2200	75/65/20°C	1093	1386	1667	1945	2761	1593	2011	2409	2792	3883	2024	2602	3144	3680	4976	2796	3555	4275	4959	6838
	55/45/20°C	567	719	865	1008	1424	825	1040	1243	1438	1973	1048	1342	1615	1883	2527	1439	1829	2197	2546	3434
	CENA	<b>1048</b>	<b>1141</b>	<b>1189</b>	<b>1267</b>	<b>1646</b>	<b>1326</b>	<b>1504</b>	<b>1650</b>	<b>1794</b>	<b>2419</b>	<b>1463</b>	<b>1769</b>	<b>2006</b>	<b>2213</b>	<b>2778</b>	<b>2251</b>	<b>2603</b>	<b>2879</b>	<b>3281</b>	<b>3930</b>
2400	75/65/20°C	1193	1512	1819	2122	3012	1738	2194	2628	3046	4236	2208	2839	3430	4015	5429	3050	3878	4663	5410	7459
	55/45/20°C	619	784	943	1100	1554	900	1134	1356	1569	2153	1143	1464	1762	2054	2757	1570	1995	2396	2777	3746
	CENA	<b>1136</b>	<b>1233</b>	<b>1284</b>	<b>1368</b>	<b>1770</b>	<b>1420</b>	<b>1621</b>	<b>1792</b>	<b>1937</b>	<b>2571</b>	<b>1574</b>	<b>1922</b>	<b>2198</b>	<b>2399</b>	<b>2904</b>	<b>2419</b>	<b>2764</b>	<b>3029</b>	<b>3442</b>	<b>4074</b>
2600	75/65/20°C	1292	1638	1971	2298	3263	1882	2377	2847	3299	4589	2392	3075	3716	4349	5881	3305	4202	5052	5860	8081
	55/45/20°C	671	850	1022	1191	1683	975	1229	1469	1699	2332	1238	1586	1908	2225	2986	1701	2161	2596	3009	4059
	CENA	<b>1180</b>	<b>1297</b>	<b>1360</b>	<b>1403</b>	<b>1912</b>	<b>1478</b>	<b>1696</b>	<b>1878</b>	<b>2052</b>	<b>2745</b>	<b>1630</b>	<b>2028</b>	<b>2346</b>	<b>2532</b>	<b>3137</b>	<b>2523</b>	<b>2912</b>	<b>3215</b>	<b>36</b>	

**CO-350****PERFEKT**  
grzejnik aluminiowy**PERFEKT**<sup>2</sup><sub>SYSTEM</sub>

indeks	wielkość	PN	Tmax	pakowanie		cena netto [zł]
<b>71-000-3500-000</b>	350	16	+95°C	10	500	<b>38,55</b>

**X** GRUPA RABATOWAProdukt dostępny  
do wyczerpania zapasów**PHA-042**Zestaw do podłączenia  
grzejnika aluminiowego**PERFEKT**<sup>2</sup><sub>SYSTEM</sub>

indeks	wielkość	PN	Tmax	pakowanie		cena netto [zł]
<b>71-942-0000-000</b>	1" x 1/2"	10	+110°C	1	50	<b>16,48</b>

**K** GRUPA RABATOWA**NP**Nypel do grzejnika  
aluminiowego

indeks	wielkość	PN	Tmax	pakowanie		cena netto [zł]
<b>71-960-0000-002</b>	1"	10	+110°C	1	500	<b>1,68</b>

**J** GRUPA RABATOWA**UZ**Uszczelka nypla do grzejnika  
aluminiowego

indeks	wielkość	pakowanie		cena netto [zł]
<b>71-960-0000-100</b>	1 mm	1	100	<b>0,33</b>
<b>71-960-0000-101</b>	1,5 mm	1	100	<b>0,35</b>

**J** GRUPA RABATOWA**TRCD10C**Głowica termostatyczna  
cieczowa M30x1.5,  
chromowana

indeks	Tmax	pakowanie		cena netto [zł]
<b>20-107-0400-000</b>	+50°C	1	100	<b>38,23</b>

**E** GRUPA RABATOWA**TRCD10**Głowica termostatyczna  
cieczowa M30x1.5,  
biała

indeks	kolor	Tmax	pakowanie		cena netto [zł]
<b>20-107-0400-100</b>	biały	+50°C	1	100	<b>39,74</b>
<b>20-107-0400-003</b>	czarny mat	+50°C	1	100	<b>37,49</b>

**E** GRUPA RABATOWA

**TRCD15**

Głowica termostatyczna cieczowa M30x1.5 z blokadą nastawy



indeks

Tmax

pakowanie

cena netto [zł]

**20-107-0300-000**

+50°C

1 100

**33,46****E** GRUPA RABATOWA**GS.07**

Głowica termostatyczna cieczowa z przyłączem RA-N do grzejników stalowych typ V

**PERFEKT<sup>2</sup>** SYSTEM

indeks

pakowanie

cena netto [zł]

**20-300-0005-000**

1 100

**68,89****H** GRUPA RABATOWA**GT01RA**

Głowica termostatyczna cieczowa z przyłączem RA z blokadą nastawy temperatury

**▶ NOWOŚĆ**

indeks

Tmax

pakowanie

cena netto [zł]

**20-300-0009-000**

+50°C

1 100

**E** GRUPA RABATOWA

dostępne w III kwartale 2024

**GT02RA**

Głowica termostatyczna cieczowa z przyłączem RA

**▶ NOWOŚĆ**

indeks

Tmax

pakowanie

cena netto [zł]

**20-300-0010-000**

+50°C

1 100

**E** GRUPA RABATOWA

dostępne w III kwartale 2024

**GT01**

Głowica termostatyczna cieczowa M30x1.5 z blokadą nastawy

**▶ NOWOŚĆ**

indeks

Tmax

pakowanie

cena netto [zł]

**20-107-0300-003**

+50°C

1 100

**25,30****E** GRUPA RABATOWA

dostępne w III kwartale 2024

**GT03**

Głowica termostatyczna cieczowa M30x1.5 z blokadą nastawy

**▶ NOWOŚĆ**

indeks

Tmax

pakowanie

cena netto [zł]

**20-107-0300-004**

+50°C

1 100

**25,30****E** GRUPA RABATOWA

dostępne w III kwartale 2024

**GT04**

Głowica termostatyczna cieczowa M30x1.5 z blokadą nastawy

**▶ NOWOŚĆ**

indeks

Tmax

pakowanie

cena netto [zł]

**20-107-0300-005**

+50°C

1 100

**25,30****E** GRUPA RABATOWA

dostępne w III kwartale 2024



**KM**

Zestaw montażowy do grzejników stalowych typu C



indeks	pakowanie		cena netto [zł]
<b>81-001-0003-000</b>	1	1	<b>12,24</b>

**Z** GRUPA RABATOWA**KDZ**

Konsola do zawieszenia grzejników stalowych typu V



indeks	wielkość	pakowanie		cena netto [zł]
<b>81-000-0300-001</b>	300	1	50	<b>37,92</b>
<b>81-000-0400-001</b>	400	1	50	<b>38,59</b>
<b>81-000-0500-001</b>	500	1	50	<b>39,22</b>
<b>81-000-0600-001</b>	600	1	50	<b>40,93</b>
<b>81-000-0900-001</b>	900	1	50	<b>46,68</b>

**Z** GRUPA RABATOWA**KGH**

Konsola do zawieszenia grzejników stalowych higienicznych



indeks	wielkość	pakowanie		cena netto [zł]
<b>81-000-0300-002</b>	300	1	1	<b>90,32</b>
<b>81-000-0400-002</b>	400	1	1	<b>96,68</b>
<b>81-000-0500-002</b>	500	1	1	<b>100,21</b>
<b>81-000-0600-002</b>	600	1	1	<b>110,79</b>
<b>81-000-0900-002</b>	900	1	1	<b>114,29</b>

**H** GRUPA RABATOWA**KW**

Konsola wolnostojąca do grzejnika stalowego



indeks	wielkość	pakowanie		cena netto [zł]
<b>81-001-0000-000</b>	300-900	1	1	<b>222,29</b>

**Z** GRUPA RABATOWA**OK**

Osłona stopy konsoli wolnostojącej



indeks	pakowanie		cena netto [zł]
<b>81-002-0000-000</b>	1	1	<b>11,83</b>

**Z** GRUPA RABATOWA



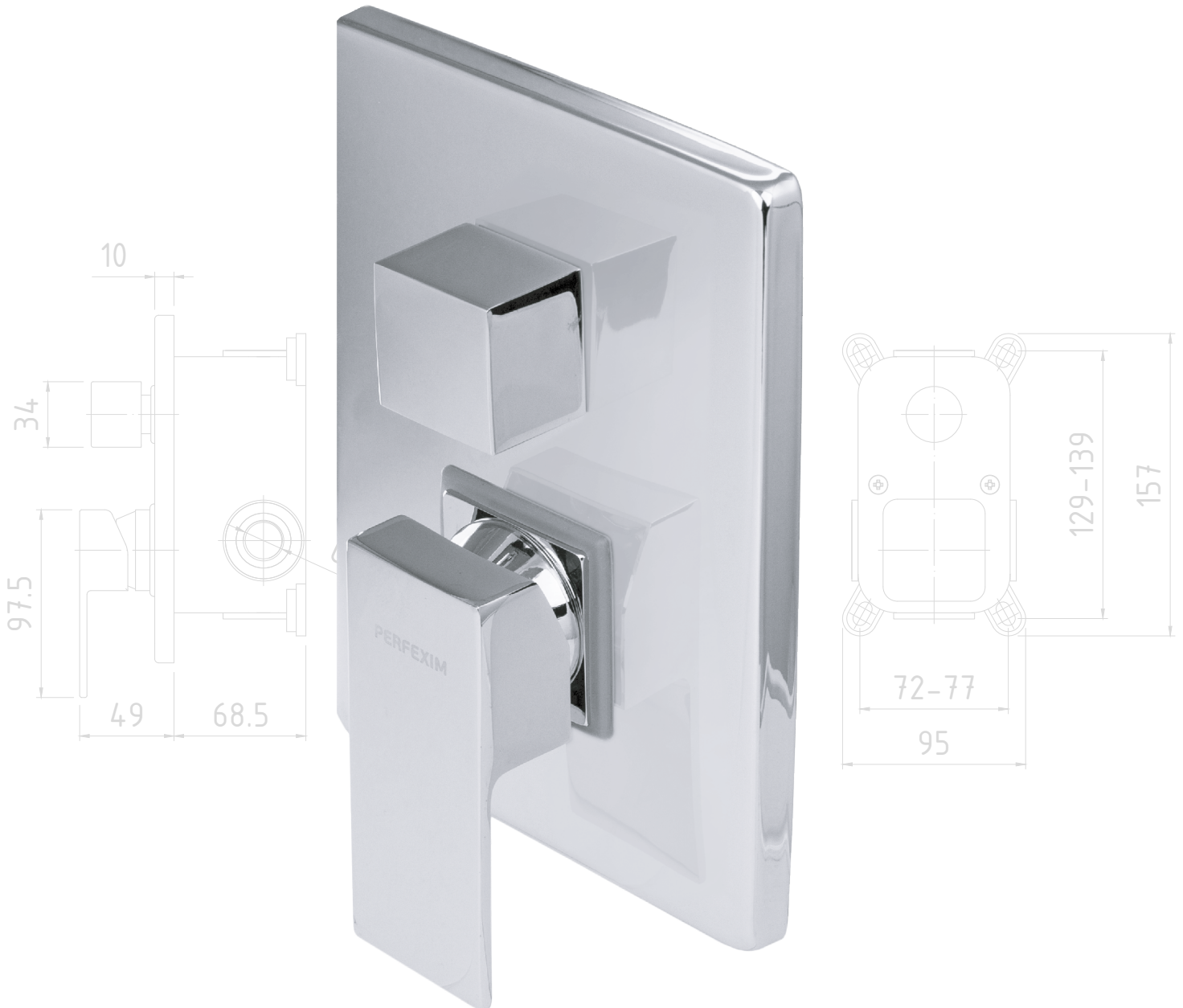

# BATERIE PODTYNKOWE 81-88

Baterie podtynkowe	82
Aksesoria do baterii podtynkowych	86

**SOP04/1P****SOPHIE**

Bateria prysznicowa podtynkowa, wyposażona w box montażowy

I GRUPA RABATOWA  
**GŁOWICA 35**

indeks	pakow. ☐	cena netto [zł]
<b>35-022-0600-000</b>	1	<b>319,60</b>

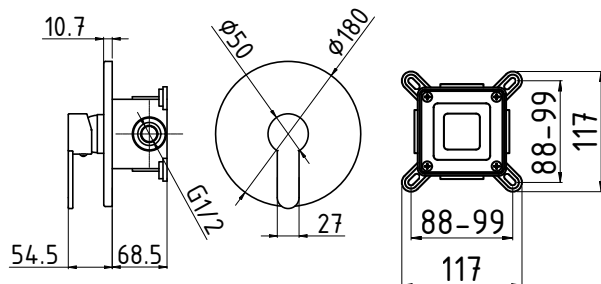
**SOP04/2P****SOPHIE**

Bateria prysznicowa podtynkowa z przełącznikiem prysznic-deszczownia, wyposażona w box montażowy

I GRUPA RABATOWA  
**GŁOWICA 40**

indeks	pakow. ☐	cena netto [zł]
<b>35-022-0600-001</b>	1	<b>514,10</b>

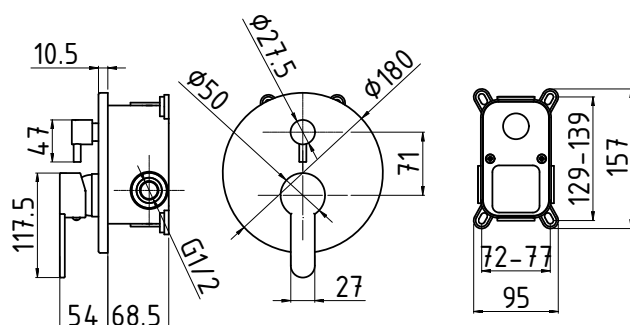

**OLI04/1P****OLIVIA**

Bateria prysznicowa podtynkowa, wyposażona w box montażowy

I GRUPA RABATOWA

**GŁOWICA 35**

indeks	pakow. ☐	cena netto [zł]
<b>35-023-0600-000</b>	<b>1</b>	<b>356,76</b>

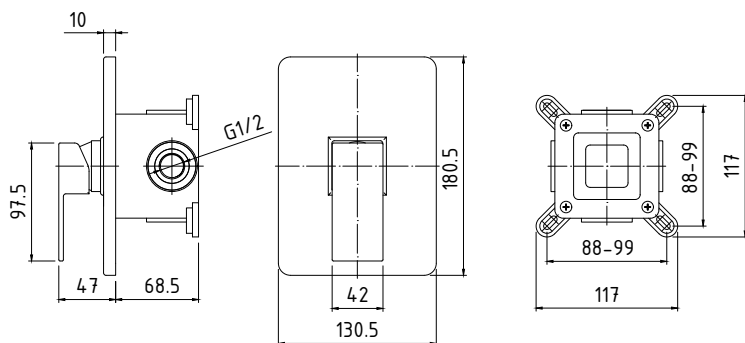
**OLI04/2P****OLIVIA**

Bateria prysznicowa podtynkowa z przełącznikiem prysznic-deszczownia, wyposażona w box montażowy

I GRUPA RABATOWA

**GŁOWICA 35**

indeks	pakow. ☐	cena netto [zł]
<b>35-023-0600-001</b>	<b>1</b>	<b>547,54</b>

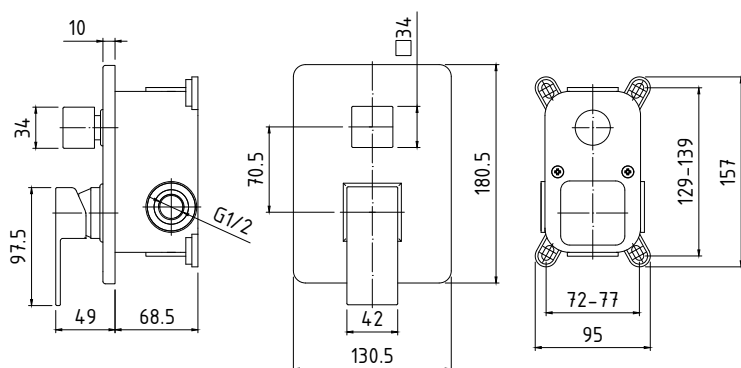

**ROS04/2P****ROSALIA**

Bateria prysznicowa podtynkowa z przełącznikiem prysznic-deszczownia, wyposażona w box montażowy

I GRUPA RABATOWA  
**GŁOWICA 40**

indeks	pakow. ☐	cena netto [zł]
<b>35-024-0600-001</b>	1	<b>590,90</b>

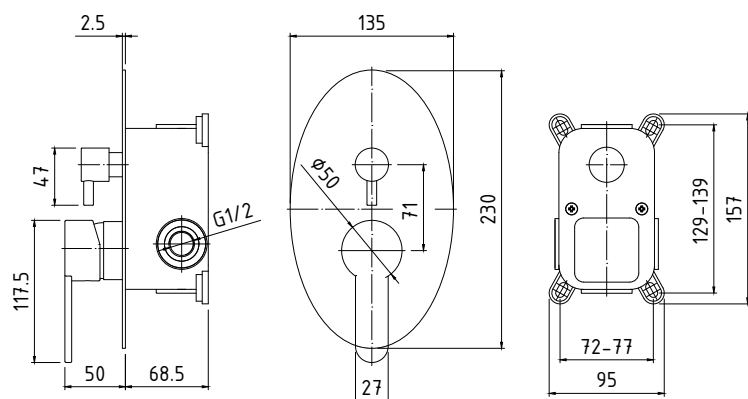
**OLI06****OLIVIA**

Bateria umywalkowa podtynkowa, wyl. stała, wyposażona w box montażowy

I GRUPA RABATOWA  
**GŁOWICA 35**

indeks	pakow. ☐	cena netto [zł]
<b>35-025-0200-000</b>	1	<b>542,57</b>

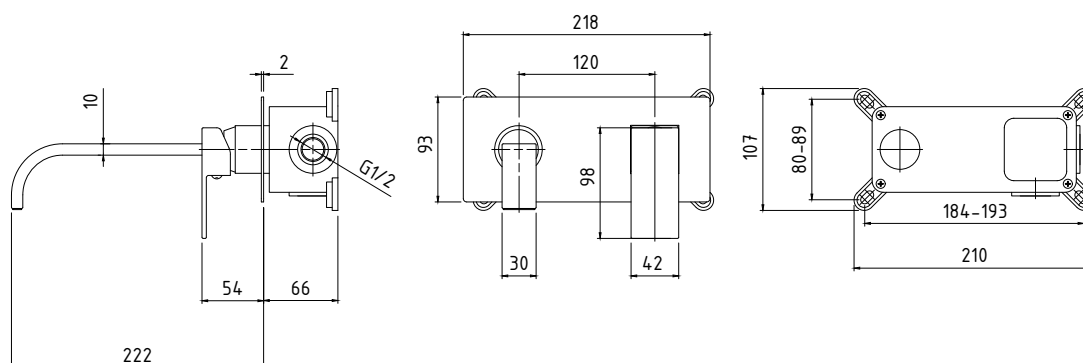

**OLI06-1**

**OLIVIA**

Bateria umywalkowa podtynkowa, wyl. stała,



GRUPA RABATOWA  
**GŁOWICA 35**

indeks	pakow.	cena netto [zł]
<b>35-025-0200-001</b>	1	<b>398,89</b>

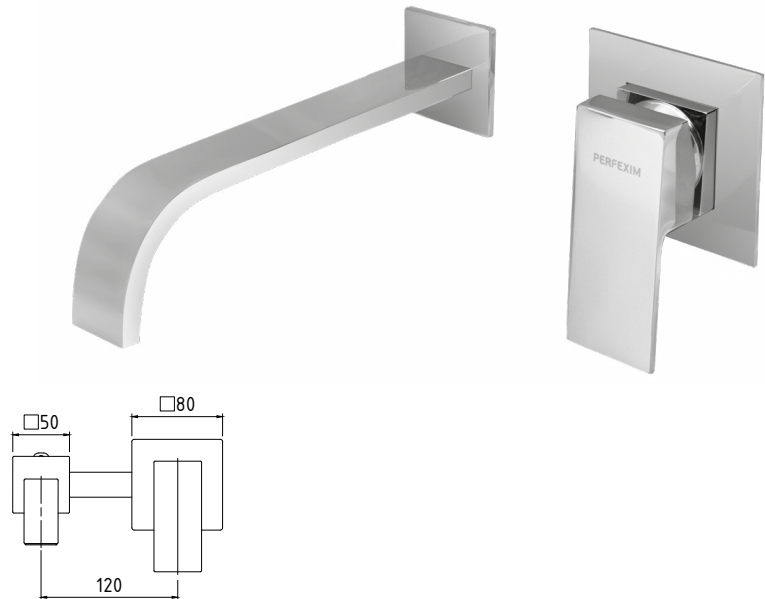
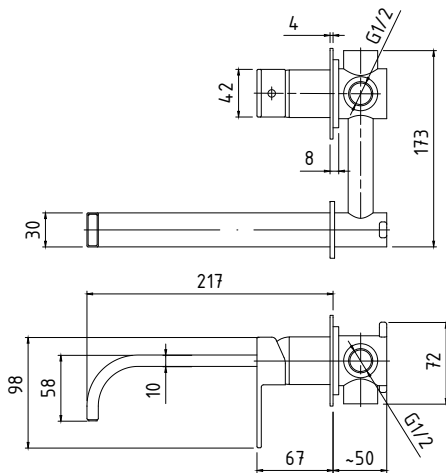

**MAR06-1**

**MARGO**

Bateria umywalkowa podtynkowa, wyl. stała



GRUPA RABATOWA  
**GŁOWICA 35**

indeks	pakow.	cena netto [zł]
<b>35-026-0200-001</b>	1	<b>447,19</b>

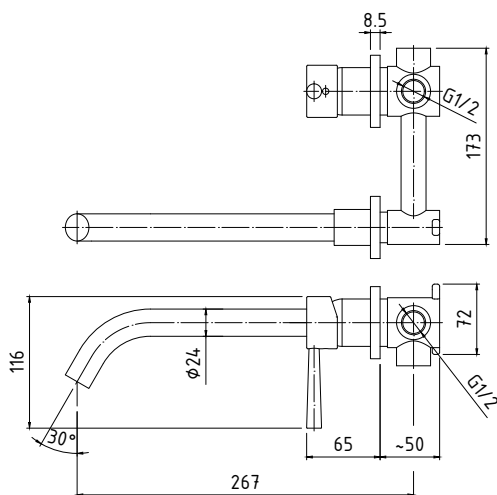

**P12**

Deszczownia PŁASKA  
kwadratowa 300mm x 300mm,  
do baterii podtynkowych



**I** GRUPA RABATOWA

indeks	pakow. ☐	cena netto [zł]
<b>35-202-0002-000</b>	<b>1</b>	<b>192,90</b>

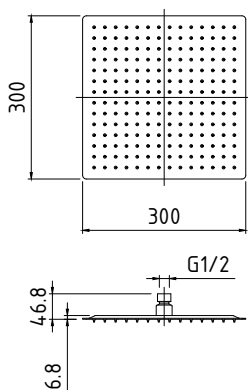
**P13**

Deszczownia PŁASKA  
kwadratowa 400mm x 400mm,  
do baterii podtynkowych



**I** GRUPA RABATOWA

indeks	pakow. ☐	cena netto [zł]
<b>35-202-0002-001</b>	<b>1</b>	<b>379,35</b>

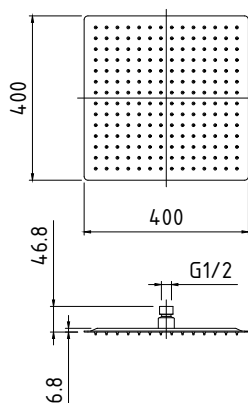
**P14**

Deszczownia PŁASKA okrągła  
Ø 300 mm, (12"), do baterii  
podtynkowych



**I** GRUPA RABATOWA

indeks	pakow. ☐	cena netto [zł]
<b>35-202-0001-000</b>	<b>1</b>	<b>167,17</b>

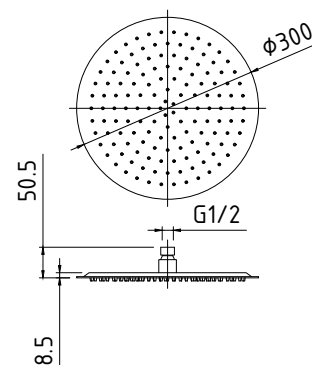
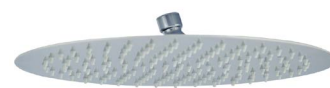
**M1**

Maskownica okrągła Ø 160 mm  
PŁASKA do baterii podtynkowych  
bez przełącznika (dedykowana  
do baterii SOPHIE SOP04/1P)



**I** GRUPA RABATOWA

indeks	pakow. ☐	cena netto [zł]
<b>35-203-0001-000</b>	<b>1</b>	<b>108,01</b>

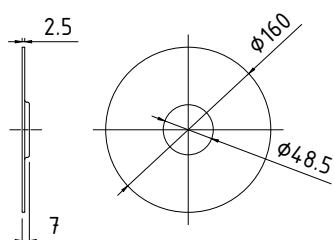
**M2**

Maskownica okrągła Ø 160mm,  
PŁASKA, do baterii podtynkowych  
z przełącznikiem (dedykowana do  
baterii SOPHIE SOP04/2P)



**I** GRUPA RABATOWA

indeks	pakow. ☐	cena netto [zł]
<b>35-203-0001-001</b>	<b>1</b>	<b>108,01</b>

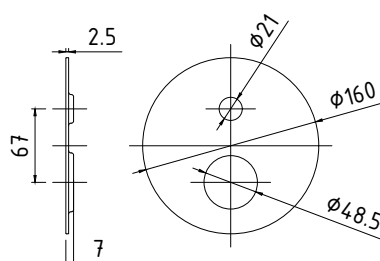
**M3**

Maskownica prostokątna  
120mm x 150mm, PŁASKA, do baterii  
podtynkowych bez przełącznika  
(dedykowana do baterii OLIVIA  
OLI04/1P)



**I** GRUPA RABATOWA

indeks	pakow. ☐	cena netto [zł]
<b>35-203-0000-000</b>	<b>1</b>	<b>102,87</b>

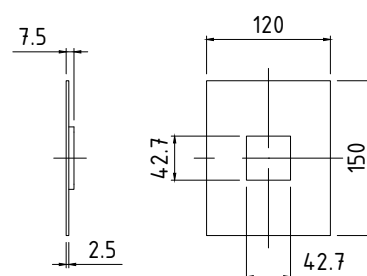
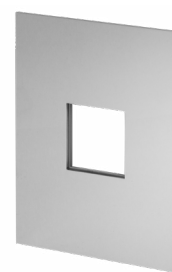

**M4**

Maskownica prostokątna 120mm x 150mm, PŁASKA, do baterii podtynkowych z przełącznikiem (dedykowana do baterii OLIVIA OLI04/2P)



GRUPA RABATOWA

indeks	pakow.	cena netto [zł]
<b>35-203-0000-001</b>	<b>1</b>	<b>108,01</b>

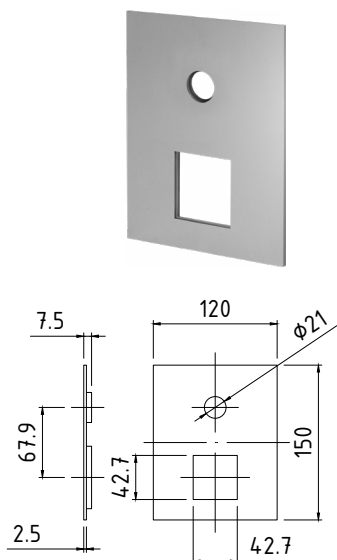
**US1**

Uchwyt zasilający do słuchawki prysznicowej - okrągły, do baterii podtynkowych



GRUPA RABATOWA

indeks	pakow.	cena netto [zł]
<b>35-208-0001-000</b>	<b>1</b>	<b>92,59</b>

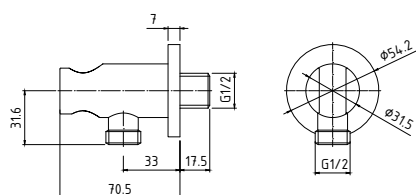
**PW01**

Przyłącze zasilające do węży prysznicowego okrągłe, do baterii podtynkowych



GRUPA RABATOWA

indeks	pakow.	cena netto [zł]
<b>35-206-0001-000</b>	<b>1</b>	<b>57,87</b>

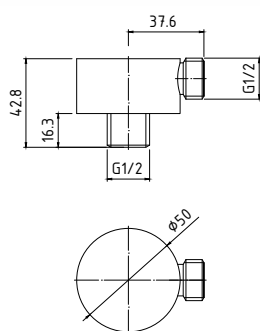
**PW02**

Przyłącze zasilające do węży prysznicowego kwadrat, do baterii podtynkowych



GRUPA RABATOWA

indeks	pakow.	cena netto [zł]
<b>35-206-0002-000</b>	<b>1</b>	<b>61,72</b>

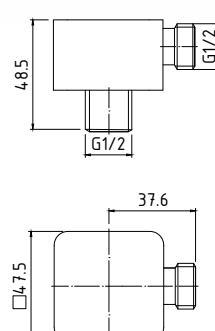
**US2**

Uchwyt zasilający do słuchawki prysznicowej - prostokątny, do baterii podtynkowych



GRUPA RABATOWA

indeks	pakow.	cena netto [zł]
<b>35-208-0002-000</b>	<b>1</b>	<b>92,59</b>

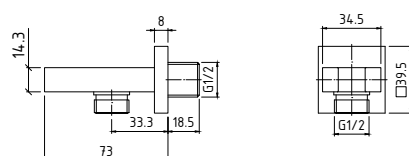
**R11**

Ramię prysznicowe poziome profil prostokątny 30x15mm, długość 400mm, do baterii podtynkowych



GRUPA RABATOWA

indeks	pakow.	cena netto [zł]
<b>35-207-0003-000</b>	<b>1</b>	<b>120,88</b>

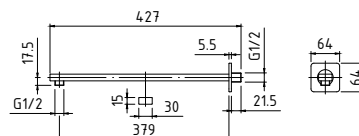

**R12**

Ramię prysznicowe poziome  
profil prostokątny 30x15mm,  
długość 500mm, do baterii  
podtynkowych



**I** GRUPA RABATOWA

indeks	pakow. ☐	cena netto [zł]
<b>35-207-0003-001</b>	<b>1</b>	<b>160,75</b>

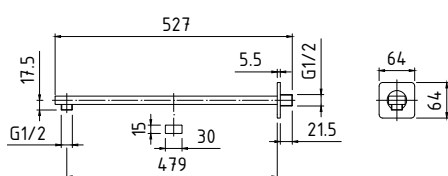
**R13**

Ramię prysznicowe poziome  
profil kwadrat 24x24mm,  
długość 400mm, do baterii  
podtynkowych



**I** GRUPA RABATOWA

indeks	pakow. ☐	cena netto [zł]
<b>35-207-0002-000</b>	<b>1</b>	<b>154,31</b>

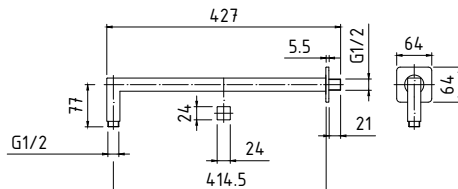
**R14**

Ramię prysznicowe poziome  
profil kwadrat 24x24mm,  
długość 500mm, do baterii  
podtynkowych



**I** GRUPA RABATOWA

indeks	pakow. ☐	cena netto [zł]
<b>35-207-0002-001</b>	<b>1</b>	<b>180,04</b>

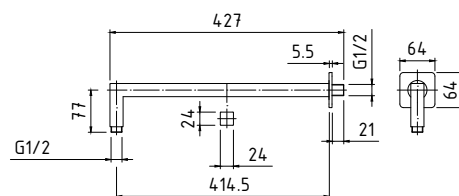
**R15**

Ramię prysznicowe poziome  
profil okrągły Ø 22, długość  
400mm, do baterii  
podtynkowych



**I** GRUPA RABATOWA

indeks	pakow. ☐	cena netto [zł]
<b>35-207-0001-000</b>	<b>1</b>	<b>102,87</b>

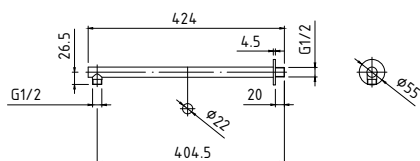
**R16**

Ramię prysznicowe poziome  
profil okrągły Ø 22, długość  
500mm, do baterii  
podtynkowych



**I** GRUPA RABATOWA

indeks	pakow. ☐	cena netto [zł]
<b>35-207-0001-001</b>	<b>1</b>	<b>122,17</b>

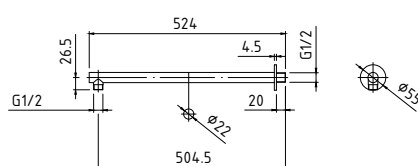





Serie klasycznych baterii łazienkowych oraz kuchennych, w których  
**TRADYCJA ŁĄCZY SIĘ  
Z NOWOCZESNOŚCIĄ**



# ARMATURA KUCHENNA I ŁAZIENKOWA 89-123

Baterie WEGA	90
Baterie RENO	92
Baterie kuchenne i łazienkowe	94
głowica 40	94
głowica 35	98
Baterie ciśnieniowe	108
Syfony	108
Korki zamykające	109
Komplety prysznicowe	114
Słuchawki z deszczownicą	115
Słuchawki	116
Drażki prysznicowe	119
Uchwyty punktowe	120
Wężę prysznicowe	121
Akcesoria łazienkowe z przyssawką	122

**84401****WEGA**

Bateria umywalkowa stojąca



GŁOWICA 35



GRUPA RABATOWA

**NEXE**  
new line

indeks	kolor	pakow. ☐	cena netto [zł]
<b>36-018-0300-003</b>	czarny mat	1	<b>283,62</b>

**84401-1****WEGA**Bateria umywalkowa stojąca  
nablatowa

GŁOWICA 35



GRUPA RABATOWA

**NEXE**  
new line

indeks	kolor	pakow. ☐	cena netto [zł]
<b>36-018-0310-003</b>	czarny mat	1	<b>584,60</b>

**84402****WEGA**

Bateria bidetowa stojąca



GŁOWICA 35



GRUPA RABATOWA

**NEXE**  
new line

indeks	kolor	pakow. ☐	cena netto [zł]
<b>36-018-0700-003</b>	czarny mat	1	<b>300,98</b>

**84403****WEGA**

Bateria wannowa naścienna



GŁOWICA 35



GRUPA RABATOWA

**NEXE**  
new line

indeks	kolor	pakow. ☐	cena netto [zł]
<b>36-018-0000-003</b>	czarny mat	1	<b>387,81</b>

**84404****WEGA**

Bateria prysznicowa naścienna



GŁOWICA 35



GRUPA RABATOWA

**NEXE**  
new line

indeks	kolor	pakow. ☐	cena netto [zł]
<b>36-018-0600-003</b>	czarny mat	1	<b>297,51</b>

**84405****WEGA**Bateria zlewozmywakowa  
stojąca

GŁOWICA 35



GRUPA RABATOWA

**NEXE**  
new line

indeks	kolor	pakow. ☐	cena netto [zł]
<b>36-018-0500-003</b>	czarny mat	1	<b>457,26</b>



**84404-11****WEGA**  
Deszczownia z baterią  
natryskową naścienna

GŁOWICA 35

**(N)** GRUPA RABATOWA**NEXE**  
new line

indeks	kolor	pakow.	cena netto [zł]
36-018-1600-003	czarny mat	1	1146,05

**84409-1****WEGA**  
Bateria prysznicowa  
podtynkowa

GŁOWICA 35

**(N)** GRUPA RABATOWA**NEXE**  
new line

indeks	kolor	pakow.	cena netto [zł]
36-018-0621-000	czarny mat	1	792,75

**84405****WEGA**  
Bateria zlewozmywakowa  
stojąca

GŁOWICA 35

**(N)** GRUPA RABATOWA**NEXE**  
new line

indeks	kolor	pakow.	cena netto [zł]
36-018-0500-001	biała	1	457,26

**84401****WEGA**  
Bateria umywalkowa stojąca

GŁOWICA 35

**(N)** GRUPA RABATOWA**NEXE**  
new line

indeks	kolor	pakow.	cena netto [zł]
36-018-0300-000	chrom	1	272,04

**84401-1****WEGA**  
Bateria umywalkowa stojąca  
nablatowa

GŁOWICA 35

**(N)** GRUPA RABATOWA**NEXE**  
new line

indeks	kolor	pakow.	cena netto [zł]
36-018-0310-000	chrom	1	530,20

**84402****WEGA**  
Bateria bidetowa stojąca

GŁOWICA 35

**(N)** GRUPA RABATOWA**NEXE**  
new line

indeks	kolor	pakow.	cena netto [zł]
36-018-0700-000	chrom	1	285,94



**84403****WEGA**

Bateria wannowa naścienna



GŁOWICA 35



GRUPA RABATOWA

**NEXE**  
new line

indeks	kolor	pakow. ☐	cena netto [zł]
<b>36-018-0000-000</b>	chrom	1	<b>346,13</b>

**84404****WEGA**

Bateria prysznicowa naścienna



GŁOWICA 35



GRUPA RABATOWA

**NEXE**  
new line

indeks	kolor	pakow. ☐	cena netto [zł]
<b>36-018-0600-000</b>	chrom	1	<b>260,46</b>

**84405****WEGA**

Bateria zlewozmywakowa stojąca



GŁOWICA 35



GRUPA RABATOWA

**NEXE**  
new line

indeks	kolor	pakow. ☐	cena netto [zł]
<b>36-018-0500-000</b>	chrom	1	<b>399,38</b>

**84404-11****WEGA**

Deszczownia z baterią natryskową naścienną



GŁOWICA 35



GRUPA RABATOWA

**NEXE**  
new line

indeks	kolor	pakow. ☐	cena netto [zł]
<b>36-018-1600-000</b>	chrom	1	<b>850,86</b>

**84409-1****WEGA**

Bateria prysznicowa podtynkowa



GŁOWICA 35



GRUPA RABATOWA

**NEXE**  
new line

indeks	kolor	pakow. ☐	cena netto [zł]
<b>36-018-0621-000</b>	chrom	1	<b>690,90</b>

**85501****RENO**

Bateria umywalkowa stojąca



GŁOWICA 35



GRUPA RABATOWA

**NEXE**  
new line

indeks	kolor	pakow. ☐	cena netto [zł]
<b>36-017-0300-000</b>		1	<b>262,78</b>



**85501-1****RENO**  
Bateria umywalkowa stojąca  
nablatowa

GŁOWICA 35

**(N)** GRUPA RABATOWA**NEXE**  
new line

indeks	pakow. ☐	cena netto [zł]
<b>36-017-0310-000</b>	1	<b>575,34</b>

**85502****RENO**  
Bateria bidetowa stojąca

GŁOWICA 35

**(N)** GRUPA RABATOWA**NEXE**  
new line

indeks	pakow. ☐	cena netto [zł]
<b>36-017-0700-000</b>	1	<b>274,35</b>

**85503****RENO**  
Bateria wannowa naścienna

GŁOWICA 35

**(N)** GRUPA RABATOWA**NEXE**  
new line

indeks	pakow. ☐	cena netto [zł]
<b>36-017-0000-000</b>	1	<b>366,96</b>

**85504****RENO**  
Bateria prysznicowa naścienna

GŁOWICA 35

**(N)** GRUPA RABATOWA**NEXE**  
new line

indeks	pakow. ☐	cena netto [zł]
<b>36-017-0600-000</b>	1	<b>320,66</b>



**CAR07**

**CARLO**  
bateria zlewozmywakowa  
wysoka stojąca



GŁOWICA 40

**I** GRUPA RABATOWA

indeks	pakow. 	cena netto <sup>[zł]</sup>
<b>35-015-0500-001</b>	1 10	<b>173,41</b>

**CAR05/22**

**CARLO**  
bateria zlewozmywakowa  
stojąca



GŁOWICA 40

**I** GRUPA RABATOWA

indeks	wyl. [cm]	pakow. 	cena netto <sup>[zł]</sup>
<b>35-015-0500-000</b>	22	1 10	<b>143,68</b>

**CAR06/22**

**CARLO**  
bateria zlewozmywakowa  
naścienna



GŁOWICA 40

**I** GRUPA RABATOWA

indeks	wyl. [cm]	pakow. 	cena netto <sup>[zł]</sup>
<b>35-015-0400-000</b>	22	1 10	<b>206,93</b>

**CAR03**

**CARLO**  
bateria wannowa naścienna  
bez akcesoriów



GŁOWICA 40

**I** GRUPA RABATOWA

indeks	pakow. 	cena netto <sup>[zł]</sup>
<b>35-015-0000-000</b>	1 10	<b>240,11</b>

**CAR06/18**

**CARLO**  
bateria umywalkowa  
naścienna



GŁOWICA 40

**I** GRUPA RABATOWA

indeks	wyl. [cm]	pakow. 	cena netto <sup>[zł]</sup>
<b>35-015-0200-000</b>	18	1 10	<b>203,78</b>



**CAR04**

**CARLO**  
bateria prysznicowa  
naścienna bez akcesoriów



GŁOWICA 40

**I** GRUPA RABATOWA

indeks	pakow. 	cena netto <sup>[zł]</sup>
<b>35-015-0600-000</b>	1 10	<b>186,40</b>

**CAR01**

**CARLO**  
bateria umywalkowa  
stojąca



GŁOWICA 40

**I** GRUPA RABATOWA

indeks	pakow. 	cena netto <sup>[zł]</sup>
<b>35-015-0100-000</b>	1 10	<b>175,32</b>

**CAR02**

**CARLO**  
bateria bidetowa



GŁOWICA 40

**I** GRUPA RABATOWA

indeks	pakow. 	cena netto <sup>[zł]</sup>
<b>35-015-0700-000</b>	1 10	<b>172,20</b>

**363**

**DALIA**  
bateria zlewozmywakowa  
stojąca



GŁOWICA 40

**I** GRUPA RABATOWA

indeks	wyl. [cm]	pakow. 	cena netto <sup>[zł]</sup>
<b>35-010-0500-000</b>	22	1 10	<b>123,99</b>

**316**

**DALIA**  
bateria zlewozmywakowa  
naścienna



GŁOWICA 40

**I** GRUPA RABATOWA

indeks	wyl. [cm]	pakow. 	cena netto <sup>[zł]</sup>
<b>35-010-0400-000</b>	22	1 10	<b>182,46</b>



**354****DALIA**  
bateria wannowa naścienna

GŁOWICA 40

GRUPA RABATOWA

indeks	pakow. 	cena netto <sup>[zł]</sup>
<b>35-010-0000-000</b>	1 10	<b>256,87</b>

**316****DALIA**  
bateria umywalkowa  
naścienna

GŁOWICA 40

GRUPA RABATOWA

indeks	wyl. [cm]	pakow. 	cena netto <sup>[zł]</sup>
<b>35-010-0200-001</b>	18	1 10	<b>180,66</b>

**315****DALIA**  
bateria prysznicowa  
naścienna

GŁOWICA 40

GRUPA RABATOWA

indeks	pakow. 	cena netto <sup>[zł]</sup>
<b>35-010-0600-000</b>	1 10	<b>194,85</b>

**361****DALIA**  
bateria umywalkowa  
stojąca

GŁOWICA 40

GRUPA RABATOWA

indeks	pakow. 	cena netto <sup>[zł]</sup>
<b>35-010-0100-000</b>	1 10	<b>152,34</b>

**362****DALIA**  
bateria bidetowa

GŁOWICA 40

GRUPA RABATOWA

indeks	pakow. 	cena netto <sup>[zł]</sup>
<b>35-010-0700-000</b>	1 10	<b>159,44</b>





**163****MALWA**  
bateria zlewozmywakowa  
stożąca

GŁOWICA 40

GRUPA RABATOWA

indeks	wyl. [cm]	pakow. 	cena netto [zł]
<b>35-008-0500-001</b>	16	1 10	<b>161,27</b>
<b>35-008-0500-000</b>	22	1 10	<b>161,27</b>

**163/1****MALWA**  
bateria zlewozmywakowa  
stożąca ze skośną wylewką

GŁOWICA 40

GRUPA RABATOWA

indeks	wyl. [cm]	pakow. 	cena netto [zł]
<b>35-008-0500-002</b>		1 10	<b>146,33</b>

**166****MALWA**  
bateria zlewozmywakowa  
naścienna

GŁOWICA 40

GRUPA RABATOWA

indeks	wyl. [cm]	pakow. 	cena netto [zł]
<b>35-008-0400-000</b>	22	1 10	<b>222,21</b>

**164****MALWA**  
bateria wannowa naścienna

GŁOWICA 40

GRUPA RABATOWA

indeks	pakow. 	cena netto [zł]
<b>35-008-0000-000</b>	1 10	<b>277,76</b>

**166****MALWA**  
bateria umywalkowa  
naścienna

GŁOWICA 40

GRUPA RABATOWA

indeks	wyl. [cm]	pakow. 	cena netto [zł]
<b>35-008-0200-000</b>	18	1 10	<b>218,63</b>



**165****MALWA**  
bateria prysznicowa  
naścienna

GŁOWICA 40

GRUPA RABATOWA

indeks	pakow. 	cena netto <sup>[zł]</sup>
<b>35-008-0600-000</b>	1 10	<b>232,97</b>

**161****MALWA**  
bateria umywalkowa  
stojąca

GŁOWICA 40

GRUPA RABATOWA

indeks	pakow. 	cena netto <sup>[zł]</sup>
<b>35-008-0100-000</b>	1 10	<b>182,78</b>

**162****MALWA**  
bateria bidetowa

GŁOWICA 40

GRUPA RABATOWA

indeks	pakow. 	cena netto <sup>[zł]</sup>
<b>35-008-0700-000</b>	1 10	<b>197,12</b>

**FAB07****FABIO**  
bateria zlewozmywakowa  
stojąca wysoka

GŁOWICA 40

GRUPA RABATOWA

indeks	pakow. 	cena netto <sup>[zł]</sup>
<b>35-016-0500-001</b>	1 12	<b>194,39</b>

**COR07****CORNELIA**  
bateria zlewozmywakowa  
stojąca wysoka

GŁOWICA 35

GRUPA RABATOWA

indeks	pakow. 	cena netto <sup>[zł]</sup>
<b>35-017-0500-001</b>	1 10	<b>267,73</b>

**ANG05/22****ANGELA**  
bateria zlewozmywakowa stojąca

GŁOWICA 35

GRUPA RABATOWA

indeks	wylewka [cm]	pakow. 	cena netto <sup>[zł]</sup>
<b>35-011-0500-000</b>	22	1 10	<b>137,11</b>



**ANG06/22****ANGELA**

bateria zlewozmywakowa naścienna



GŁOWICA 35

I GRUPA RABATOWA

indeks	wylewka [cm]	pakow. 	cena netto [zł]
35-011-0400-000	22	1 10	219,07

**ANG04****ANGELA**

bateria prysznicowa bez akcesoriów



GŁOWICA 35

I GRUPA RABATOWA

indeks	pakow. 	cena netto [zł]
35-011-0600-000	1 10	196,74

**ANG01****ANGELA**

bateria umywalkowa stojąca



GŁOWICA 35

I GRUPA RABATOWA

indeks	pakow. 	cena netto [zł]
35-011-0100-000	1 10	173,00

**ANG02****ANGELA**

bateria bidetowa



GŁOWICA 35

I GRUPA RABATOWA

indeks	pakow. 	cena netto [zł]
35-011-0700-000	1 10	177,35

**BIA04****BIANCA**

bateria prysznicowa bez akcesoriów



GŁOWICA 35

I GRUPA RABATOWA

indeks	pakow. 	cena netto [zł]
35-012-0600-000	1 10	203,23

**BIA01****BIANCA**

bateria umywalkowa stojąca



GŁOWICA 35

I GRUPA RABATOWA

indeks	pakow. 	cena netto [zł]
35-012-0100-000	1 10	212,90



**ANG03**

**ANGELA**  
bateria wannowa bez  
akcesoriów



GŁOWICA 35

**I** GRUPA RABATOWA

indeks	pakow. 	cena netto <sup>[zł]</sup>
<b>35-011-0000-000</b>	1 12	<b>244,39</b>

**ANG06/18**

**ANGELA**  
bateria umywalkowa  
naścienna



GŁOWICA 35

**I** GRUPA RABATOWA

indeks	wyl. [cm]	pakow. 	cena netto <sup>[zł]</sup>
<b>35-011-0200-000</b>	18	1 10	<b>216,10</b>

**BIA05/22**

**BIANCA**  
bateria zlewozmywakowa  
stojąca



GŁOWICA 35

**I** GRUPA RABATOWA

indeks	wyl. [cm]	pakow. 	cena netto <sup>[zł]</sup>
<b>35-012-0500-000</b>	22	1 10	<b>137,58</b>

**BIA06/22**

**BIANCA**  
bateria zlewozmywakowa  
naścienna



GŁOWICA 35

**I** GRUPA RABATOWA

indeks	wyl. [cm]	pakow. 	cena netto <sup>[zł]</sup>
<b>35-012-0400-000</b>	22	1 10	<b>231,01</b>



**BIA03****BIANCA**bateria wannowa bez  
akcesoriów

GŁOWICA 35

I GRUPA RABATOWA

indeks	pakow. ☐ ☐	cena netto [zł]
35-012-0000-000	1 10	273,43

**BIA06/18****BIANCA**bateria umywalkowa  
naścienna

GŁOWICA 35

I GRUPA RABATOWA

indeks	wyl. [cm]	pakow. ☐ ☐	cena netto [zł]
35-012-0200-000	18	1 10	228,10

**ENR03****ENRICA**bateria wannowa bez  
akcesoriów

GŁOWICA 35

I GRUPA RABATOWA

indeks	pakow. ☐ ☐	cena netto [zł]
35-013-0000-000	1 10	219,32

**ENR06/18****ENRICA**bateria umywalkowa  
naścienna

GŁOWICA 35

I GRUPA RABATOWA

indeks	wyl. [cm]	pakow. ☐ ☐	cena netto [zł]
35-013-0200-000	18	1 10	191,54



**BIA02****BIANCA**

bateria bidetowa



GŁOWICA 35

**I** GRUPA RABATOWA

indeks	pakow. 	cena netto [zł]
<b>35-012-0700-000</b>	1 10	<b>209,10</b>

**ENR07****ENRICA**

bateria zlewozmywakowa stojąca wysoka



GŁOWICA 35

**I** GRUPA RABATOWA

indeks	pakow. 	cena netto [zł]
<b>35-013-0500-001</b>	1 10	<b>174,26</b>

**ENR05/16  
ENR05/22****ENRICA**  
bateria zlewozmywakowa stojąca

GŁOWICA 35

**I** GRUPA RABATOWA

indeks	wyl. [cm]	pakow. 	cena netto [zł]
<b>35-013-0501-000</b>	16	1 10	<b>127,21</b>
<b>35-013-0500-000</b>	22	1 10	<b>132,98</b>

**ENR06/22****ENRICA**

bateria zlewozmywakowa ścienna



GŁOWICA 35

**I** GRUPA RABATOWA

indeks	wyl. [cm]	pakow. 	cena netto [zł]
<b>35-013-0400-000</b>	22	1 10	<b>194,47</b>

**ENR04****ENRICA**

bateria prysznicowa bez akcesoriów



GŁOWICA 35

**I** GRUPA RABATOWA

indeks	pakow. 	cena netto [zł]
<b>35-013-0600-000</b>	1 10	<b>176,91</b>

**ENR01****ENRICA**

bateria umywalkowa stojąca



GŁOWICA 35

**I** GRUPA RABATOWA

indeks	pakow. 	cena netto [zł]
<b>35-013-0100-000</b>	1 10	<b>162,27</b>



**ENR02****ENRICA**  
bateria bidetowa

GŁOWICA 35

GRUPA RABATOWA

indeks	pakow. 	cena netto <sup>[zł]</sup>
<b>35-013-0700-000</b>	1 10	<b>159,39</b>

**1004****IRYS**  
bateria prysznicowa  
naścienna

GŁOWICA 35

GRUPA RABATOWA

indeks	pakow. 	cena netto <sup>[zł]</sup>
<b>35-001-0600-000</b>	1 12	<b>241,82</b>

**1001-I  
1001-I/BS****IRYS**  
bateria umywalkowa  
stojąca z/bez spustu

GŁOWICA 35

GRUPA RABATOWA

indeks	spust	pakow. 	cena netto <sup>[zł]</sup>
<b>35-001-0100-001</b>	tak	1 12	<b>169,12</b>
<b>35-001-0100-002</b>	nie	1 12	<b>158,17</b>

**1005****IRYS**  
bateria zlewozmywakowa  
stojąca

GŁOWICA 35

GRUPA RABATOWA

indeks	wyl. [cm]	pakow. 	cena netto <sup>[zł]</sup>
<b>35-001-0500-000</b>	16	1 10	<b>171,15</b>
<b>35-001-0501-000</b>	22	1 10	<b>171,15</b>

**1006****IRYS**  
bateria zlewozmywakowa  
naścienna

GŁOWICA 35

GRUPA RABATOWA

indeks	wyl. [cm]	pakow. 	cena netto <sup>[zł]</sup>
<b>35-001-0400-000</b>	22	1 12	<b>245,56</b>



**1003****IRYS**

bateria wannowa naścienna



GŁOWICA 35

GRUPA RABATOWA

indeks	pakow. 	cena netto <sup>[zł]</sup>
<b>35-001-0000-000</b>	1 12	<b>279,05</b>

**1006/1****IRYS**

bateria umywalkowa naścienna



GŁOWICA 35

GRUPA RABATOWA

indeks	wyl. [cm]	pakow. 	cena netto <sup>[zł]</sup>
<b>35-001-0200-000</b>	18	1 10	<b>239,99</b>
<b>35-001-0201-000</b>	14	1 10	<b>234,41</b>

**1002****IRYS**

bateria bidetowa



GŁOWICA 35

GRUPA RABATOWA

indeks	pakow. 	cena netto <sup>[zł]</sup>
<b>35-001-0700-000</b>	1 10	<b>184,07</b>

**LAU07****LAURA**

bateria zlewozmywakowa stojąca wysoka



GŁOWICA 35

GRUPA RABATOWA

indeks	pakow. 	cena netto <sup>[zł]</sup>
<b>35-014-0500-001</b>	1 10	<b>179,01</b>

**LAU05/22****LAURA**

bateria zlewozmywakowa stojąca



GŁOWICA 35

GRUPA RABATOWA

indeks	wyl. [cm]	pakow. 	cena netto <sup>[zł]</sup>
<b>35-014-0500-000</b>	22	1 10	<b>135,82</b>





**LAU06/22**

**LAURA**  
bateria zlewozmywakowa  
naścienna



GŁOWICA 35

**I** GRUPA RABATOWA

indeks	wyl. [cm]	pakow. 	cena netto [zł]
<b>35-014-0400-000</b>	22	1 10	<b>196,34</b>

**LAU04**

**LAURA**  
bateria prysznicowa bez  
akcesoriów



GŁOWICA 35

**I** GRUPA RABATOWA

indeks	wyl. [cm]	pakow. 	cena netto [zł]
<b>35-014-0600-000</b>		1 10	<b>178,62</b>

**LAU01**

**LAURA**  
bateria umywalkowa  
stojąca



GŁOWICA 35

**I** GRUPA RABATOWA

indeks	wyl. [cm]	pakow. 	cena netto [zł]
<b>35-014-0100-000</b>		1 10	<b>168,34</b>

**LAU02**

**LAURA**  
bateria bidetowa



GŁOWICA 35

**I** GRUPA RABATOWA

indeks	wyl. [cm]	pakow. 	cena netto [zł]
<b>35-014-0700-000</b>		1 10	<b>160,92</b>

**902/B**

**LILIA**  
bateria zlewozmywakowa  
stojąca



GŁOWICA 35

**I** GRUPA RABATOWA

indeks	wyl. [cm]	pakow. 	cena netto [zł]
<b>35-003-0500-000</b>	22	1 10	<b>171,15</b>

**903/B**

**LILIA**  
bateria zlewozmywakowa  
naścienna



GŁOWICA 35

**I** GRUPA RABATOWA

indeks	wyl. [cm]	pakow. 	cena netto [zł]
<b>35-003-0400-000</b>	22	1 12	<b>245,56</b>



**1015**  
**LILIA**  
bateria wannowa naścienna



GŁOWICA 35

GRUPA RABATOWA

indeks	pakow.	cena netto
		[zł]
<b>35-003-0000-000</b>	1 12	<b>279,05</b>



**2015**  
**LILIA**  
bateria prysznicowa naścienna



GŁOWICA 35

GRUPA RABATOWA

indeks	pakow.	cena netto
		[zł]
<b>35-003-0600-000</b>	1 12	<b>241,82</b>



**LAU03**  
**LAURA**  
bateria wannowa bez akcesoriów



GŁOWICA 35

GRUPA RABATOWA

indeks	pakow.	cena netto
		[zł]
<b>35-014-0000-000</b>	1 10	<b>225,87</b>



**LAU06/18**  
**LAURA**  
bateria umywalkowa naścienna



GŁOWICA 35

GRUPA RABATOWA

indeks	wyl. [cm]	pakow.	cena netto
			[zł]
<b>35-014-0200-000</b>	18	1 10	<b>193,38</b>



**903/B**  
**LILIA**  
bateria umywalkowa naścienna



GŁOWICA 35

GRUPA RABATOWA

indeks	wyl. [cm]	pakow.	cena netto
			[zł]
<b>35-003-0200-000</b>	16	1 12	<b>239,99</b>



**3015-I  
3015-I/BS****LILIA**  
bateria umywalkowa  
stożąca z/bez spustu

GŁOWICA 35

**I** GRUPA RABATOWA

indeks	spust	pakow. ☐ ☐	cena netto [zł]
<b>35-003-0100-001</b>	tak	1 12	<b>169,12</b>
<b>35-003-0100-002</b>	nie	1 12	<b>158,17</b>

**7003****MAK**  
bateria wannowa naścienna**I** GRUPA RABATOWA

indeks	pakow. ☐ ☐	cena netto [zł]
<b>35-000-0000-000</b>	1 10	<b>290,25</b>

**4015****LILIA**  
bateria bidetowa

GŁOWICA 35

**I** GRUPA RABATOWA

indeks	pakow. ☐ ☐	cena netto [zł]
<b>35-003-0700-000</b>	1 10	<b>189,75</b>

**7004****MAK**  
bateria prysznicowa  
naścienna**I** GRUPA RABATOWA

indeks	pakow. ☐ ☐	cena netto [zł]
<b>35-000-0600-000</b>	1 20	<b>217,79</b>

**7007-1 / 7007-2****MAK**  
bateria umywalkowa  
naścienna jednotworowa  
typ C/typ S**I** GRUPA RABATOWA

indeks	wyl. [mm]	pakow. ☐ ☐	cena netto [zł]
<b>35-000-0002-000</b>	18 C	2 40	<b>75,46</b>
<b>35-000-0003-000</b>	18 S	2 40	<b>75,46</b>

**7005****MAK**  
bateria zlewomywakowa  
stożąca**I** GRUPA RABATOWA

indeks	pakow. ☐ ☐	cena netto [zł]
<b>35-000-0502-000</b>	1 10	<b>164,35</b>



**7006 / 7006/1****MAK**  
bateria umywalkowa naścienna**I** GRUPA RABATOWA

indeks	wyl. [cm]	typ	symbol	pak.	cena netto [zł]
<b>35-000-0200-000</b>	18	C	7006	1 10	<b>180,92</b>
<b>35-000-0201-000</b>	18	S	7006	1 10	<b>180,92</b>
<b>35-000-0400-000</b>	22	C	7006-1	1 10	<b>185,98</b>
<b>35-000-0401-000</b>	22	S	7006-1	1 10	<b>185,98</b>

**S2**Zawór ciśnieniowy  
spłukujący czasowy**N** GRUPA RABATOWA**NEXE**  
new line

indeks	pakow.	cena netto [zł]
<b>35-501-0002-000</b>	1	<b>193,53</b>

**S3**Bateria ciśnieniowa  
umywalkowa czasowa**N** GRUPA RABATOWA**NEXE**  
new line

indeks	pakow.	cena netto [zł]
<b>35-501-0003-000</b>	1	<b>157,27</b>

**SYMISO**

Syfon mosiężny okrągły

**N** GRUPA RABATOWA**NEXE**  
new line

indeks	kolor	pakow.	cena netto [zł]
<b>36-200-0000-000</b>	chrom	1 1	<b>142,37</b>
<b>36-200-0000-003</b>	czarny mat	1 1	<b>203,39</b>
<b>36-200-0000-006</b>	złoty	1 1	<b>203,39</b>
<b>36-200-0000-007</b>	różowe złoto	1 1	<b>203,39</b>



chrom



czarny mat



złoty

różowe  
złoto**S4**Bateria ciśnieniowa  
umywalkowa czasowa**N** GRUPA RABATOWA**NEXE**  
new line

indeks	pakow.	cena netto [zł]
<b>35-501-0004-000</b>	1	<b>157,27</b>

**SYMYSK**

Syfon mosiężny kwadratowy

**N** GRUPA RABATOWA**NEXE**  
new line

indeks	kolor	pakow.	cena netto [zł]
<b>36-220-0000-000</b>	chrom	1 1	<b>165,25</b>
<b>36-220-0000-001</b>	biały	1 1	<b>241,52</b>
<b>36-220-0000-003</b>	czarny mat	1 1	<b>241,52</b>
<b>36-220-0000-006</b>	złoty	1 1	<b>241,52</b>
<b>36-220-0000-007</b>	różowe złoto	1 1	<b>241,52</b>

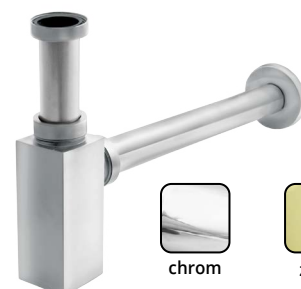

chrom



złoty



biały

różowe  
złoto

czarny mat

**SPPMWK****CLICK-CLACK**

G1¼ z przelewem, wysoki z  
koszem, przycisk duży,  
okrągły, wypukły

(N) GRUPA RABATOWA

**NEXE**  
new line

indeks	kolor	pakow. ☐ ☐	cena netto [zł]
<b>36-300-0000-000</b>	chrom	1 1	<b>74,95</b>
<b>36-300-0000-003</b>	czarny mat	1 1	<b>74,95</b>
<b>36-300-0000-006</b>	złoty	1 1	<b>74,95</b>
<b>36-300-0000-007</b>	różowe złoto	1 1	<b>74,95</b>



chrom



złoty



czarny mat

różowe  
złoto**SPPMWK****CLICK-CLACK**

G1¼ z przelewem, wysoki z  
koszem, przycisk duży,  
okrągły, płaski

(N) GRUPA RABATOWA

**NEXE**  
new line

indeks	kolor	pakow. ☐ ☐	cena netto [zł]
<b>36-300-0010-000</b>	chrom	1 1	<b>74,95</b>
<b>36-300-0010-001</b>	biały	1 1	<b>74,95</b>
<b>36-300-0010-003</b>	czarny mat	1 1	<b>74,95</b>
<b>36-300-0010-006</b>	złoty	1 1	<b>74,95</b>
<b>36-300-0010-007</b>	różowe złoto	1 1	<b>74,95</b>



chrom



złoty



biały

różowe  
złoto

czarny mat

**SPPMWK****CLICK-CLACK**

G1¼ z przelewem, wysoki z  
koszem, przycisk  
kwadratowy, wypukły

(N) GRUPA RABATOWA

**NEXE**  
new line

indeks	kolor	pakow. ☐ ☐	cena netto [zł]
<b>36-300-0020-000</b>	chrom	1 1	<b>78,52</b>
<b>36-300-0020-001</b>	biały	1 1	<b>78,52</b>
<b>36-300-0020-003</b>	czarny mat	1 1	<b>78,52</b>
<b>36-300-0020-006</b>	złoty	1 1	<b>78,52</b>
<b>36-300-0020-007</b>	różowe złoto	1 1	<b>78,52</b>



chrom



złoty



biały

różowe  
złoto

czarny mat

**SPPMK****CLICK-CLACK**

G1¼ z przelewem, z koszem,  
przycisk duży, okrągły,  
wypukły

(N) GRUPA RABATOWA

**NEXE**  
new line

indeks	kolor	pakow. ☐ ☐	cena netto [zł]
<b>36-300-1000-000</b>	chrom	1 1	<b>74,95</b>
<b>36-300-1000-001</b>	biały	1 1	<b>74,95</b>
<b>36-300-1000-003</b>	czarny mat	1 1	<b>74,95</b>
<b>36-300-1000-006</b>	złoty	1 1	<b>74,95</b>
<b>36-300-1000-007</b>	różowe złoto	1 1	<b>74,95</b>



chrom



złoty



biały

różowe  
złoto

czarny mat



**SPPMK****CLICK-CLACK**

G1¼ z przelewem, z koszem,  
przycisk duży, okrągły, płaski

(N) GRUPA RABATOWA

**NEXE**  
new line

indeks	kolor	pakow. ☐ ☐	cena netto [zł]
<b>36-300-1010-000</b>	chrom	1 1	<b>74,95</b>
<b>36-300-1010-001</b>	biały	1 1	<b>74,95</b>
<b>36-300-1010-003</b>	czarny mat	1 1	<b>74,95</b>
<b>36-300-1010-006</b>	złoty	1 1	<b>74,95</b>
<b>36-300-1010-007</b>	różowe złoto	1 1	<b>74,95</b>



chrom



złoty



biały

różowe  
złoto

czarny mat

**SPPMW****CLICK-CLACK**

G1¼ z przelewem, wysoki  
przycisk duży okrągły  
wypukły

(N) GRUPA RABATOWA

**NEXE**  
new line

indeks	kolor	pakow. ☐ ☐	cena netto [zł]
<b>36-400-0000-000</b>	chrom	1 1	<b>71,39</b>
<b>36-400-0000-001</b>	biały	1 1	<b>71,39</b>
<b>36-400-0000-003</b>	czarny mat	1 1	<b>71,39</b>



chrom



biały



czarny mat

**SPPMW****CLICK-CLACK**

G1¼ z przelewem, wysoki  
przycisk duży okrągły płaski

(N) GRUPA RABATOWA

**NEXE**  
new line

indeks	kolor	pakow. ☐ ☐	cena netto [zł]
<b>36-400-0010-000</b>	chrom	1 1	<b>71,39</b>
<b>36-400-0010-003</b>	czarny mat	1 1	<b>71,39</b>



chrom



czarny mat

**SPPMW****CLICK-CLACK**

G1¼ z przelewem, wysoki  
przycisk kwadratowy wypukły

(N) GRUPA RABATOWA

**NEXE**  
new line

indeks	kolor	pakow. ☐ ☐	cena netto [zł]
<b>36-400-0020-000</b>	chrom	1 1	<b>76,15</b>
<b>36-400-0020-003</b>	czarny mat	1 1	<b>76,15</b>



chrom



czarny mat



**SPPM****CLICK-CLACK**G1¼ z przelewem, przycisk  
duży okrągły wypukły**(N)** GRUPA RABATOWA**NEXE**  
new line

indeks	kolor	pakow. ☐ ☐	cena netto [zł]
<b>36-400-1000-000</b>	chrom	1 1	<b>71,39</b>
<b>36-400-1000-001</b>	biały	1 1	<b>71,39</b>
<b>36-400-1000-003</b>	czarny mat	1 1	<b>71,39</b>



chrom



biały



czarny mat

**SPPM****CLICK-CLACK**G1¼ z przelewem, przycisk  
duży okrągły płaski**(N)** GRUPA RABATOWA**NEXE**  
new line

indeks	kolor	pakow. ☐ ☐	cena netto [zł]
<b>36-400-1010-000</b>	chrom	1 1	<b>71,39</b>
<b>36-400-1010-003</b>	czarny mat	1 1	<b>71,39</b>



chrom



czarny mat

**SPPM****CLICK-CLACK**G1¼ z przelewem, przycisk  
kwadratowy wypukły**(N)** GRUPA RABATOWA**NEXE**  
new line

indeks	kolor	pakow. ☐ ☐	cena netto [zł]
<b>36-400-1020-000</b>	chrom	1 1	<b>76,15</b>
<b>36-400-1020-003</b>	czarny mat	1 1	<b>76,15</b>



chrom



czarny mat

**SPMWK****CLICK-CLACK**G1¼ bez przelewu, wysoki, z  
koszem, przycisk duży  
okrągły, wypukły**(N)** GRUPA RABATOWA**NEXE**  
new line

indeks	kolor	pakow. ☐ ☐	cena netto [zł]
<b>36-310-0000-000</b>	chrom	1 1	<b>74,95</b>
<b>36-310-0000-001</b>	biały	1 1	<b>79,72</b>
<b>36-310-0000-003</b>	czarny mat	1 1	<b>79,72</b>



chrom



biały



czarny mat



**SPMWK****CLICK-CLACK**

G1¼ bez przelewu, wysoki, z koszem, przycisk duży okrągły, płaski

(N) GRUPA RABATOWA

**NEXE**  
new line

indeks	kolor	pakow. ☐ ☐	cena netto [zł]
<b>36-310-0010-000</b>	chrom	1 1	<b>73,77</b>
<b>36-310-0010-003</b>	czarny mat	1 1	<b>73,77</b>



chrom



czarny mat

**SPMWK****CLICK-CLACK**

G1¼ bez przelewu, wysoki, z koszem, przycisk kwadratowy, wypukły

(N) GRUPA RABATOWA

**NEXE**  
new line

indeks	kolor	pakow. ☐ ☐	cena netto [zł]
<b>36-310-0020-000</b>	chrom	1 1	<b>76,15</b>
<b>36-310-0020-003</b>	czarny mat	1 1	<b>76,15</b>



chrom



czarny mat

**SPPMWK****CLICK-CLACK**

G1¼ z przelewem, wysoki, z koszem, przycisk ceramiczny duży, okrągły, wypukły

(N) GRUPA RABATOWA

**NEXE**  
new line

indeks	kolor	pakow. ☐ ☐	cena netto [zł]
<b>36-300-0040-001</b>	biały	1 1	<b>80,90</b>
<b>36-300-0040-005</b>	czarny	1 1	<b>80,90</b>



biały



czarny

**SPPT01E****CLICK-CLACK**

G1¼ z przelewem, przycisk duży okrągły wypukły chromowany

(N) GRUPA RABATOWA

**NEXE**  
new line

indeks	kolor	pakow. ☐ ☐	cena netto [zł]
<b>36-500-1000-000</b>	biały	1 1	<b>20,34</b>





**SPPT05E****CLICK-CLACK**

G1¼ z przelewem, przycisk mały okrągły płaski chromowany

**(N)** GRUPA RABATOWA

**NEXE**  
new line

indeks	kolor	pakow. ☐ ☐	cena netto [zł]
<b>36-500-1050-000</b>	biały	1 1	<b>18,80</b>

**PR04**

Przycisk ceramiczny, duży okrągły, wypukły

**(N)** GRUPA RABATOWA

**NEXE**  
new line

indeks	kolor	pakow. ☐ ☐	cena netto [zł]
<b>36-140-0000-001</b>	biały	1 1	<b>22,04</b>
<b>36-140-0000-005</b>	czarny	1 1	<b>22,04</b>



biały



czarny

**SPPTB01****CLICK-CLACK**

G1¼ z przelewem, z blokadą przycisk duży okrągły wypukły chromowany

**(N)** GRUPA RABATOWA

**NEXE**  
new line

indeks	kolor	pakow. ☐ ☐	cena netto [zł]
<b>36-500-1000-100</b>	czarny	1 1	<b>20,23</b>

**PR01**

Przycisk mosiężny okrągły, wypukły

**(N)** GRUPA RABATOWA

**NEXE**  
new line

indeks	kolor	pakow. ☐ ☐	cena netto [zł]
<b>36-130-0000-000</b>	chrom	1 1	<b>20,81</b>
<b>36-130-0000-001</b>	biały	1 1	<b>20,81</b>
<b>36-130-0000-003</b>	czarny mat	1 1	<b>20,81</b>
<b>36-130-0000-006</b>	złoty	1 1	<b>20,81</b>
<b>36-130-0000-007</b>	różowe złoto	1 1	<b>20,81</b>



chrom



złoty



biały



różowe złoto



czarny mat



**PR02**Przycisk mosiężny  
okrągły, płaski**(N)** GRUPA RABATOWA**NEXE**  
new line

indeks	kolor	pakow. ☐ ☐	cena netto [zł]
<b>36-130-0010-000</b>	chrom	1 1	<b>20,81</b>
<b>36-130-0010-001</b>	biały	1 1	<b>20,81</b>
<b>36-130-0010-003</b>	czarny mat	1 1	<b>20,81</b>
<b>36-130-0010-006</b>	złoty	1 1	<b>20,81</b>
<b>36-130-0010-007</b>	różowe złoto	1 1	<b>20,81</b>



chrom



złoty



biały

różowe  
złoto

czarny mat

**PR03**Przycisk mosiężny  
kwadratowy, wypukły**(N)** GRUPA RABATOWA**NEXE**  
new line

indeks	kolor	pakow. ☐ ☐	cena netto [zł]
<b>36-130-0020-000</b>	chrom	1 1	<b>26,93</b>
<b>36-130-0020-001</b>	biały	1 1	<b>30,61</b>
<b>36-130-0020-003</b>	czarny mat	1 1	<b>30,61</b>
<b>36-130-0020-006</b>	złoty	1 1	<b>30,61</b>
<b>36-130-0020-007</b>	różowe złoto	1 1	<b>30,61</b>



chrom



złoty



biały

różowe  
złoto

czarny mat

**8B**Korek zamykający  
click-clack z przelewem,  
umywalkowy, okrągły,  
36 mm**(N)** GRUPA RABATOWA**NEXE**  
new line

indeks	kolor	pakow. ☐ ☐	cena netto [zł]
<b>36-104-0003-000</b>	chrom	1 50	<b>45,76</b>

**12**Korek zamykający  
click-clack z przelewem,  
umywalkowy, kwadratowy,  
68 mm**(N)** GRUPA RABATOWA**NEXE**  
new line

indeks	kolor	pakow. ☐ ☐	cena netto [zł]
<b>36-104-0000-000</b>	chrom	1 30	<b>80,12</b>

**NA-112PR+NA-1113X****IBIZA**  
komplet prysnicowy  
ze słuchawką 3-funkcyjną**(I)** GRUPA RABATOWA

indeks	pakow. ☐ ☐	cena netto [zł]
<b>35-200-0024-000</b>	1 10	<b>95,24</b>



**ZY-3046****LIMITA**komplet prysznicowy  
ze słuchawką 1-funkcyjną**I** GRUPA RABATOWA

indeks	pakow. 	cena netto [zł]
<b>35-200-0030-000</b>	1 1	<b>219,20</b>

**20**Komplet prysznicowy  
ze słuchawką 1-funkcyjną**N** GRUPA RABATOWA**NEXE**  
new line

indeks	pakow. 	cena netto [zł]
<b>36-105-0001-000</b>	1 1	<b>415,99</b>

Produkt dostępny  
do wyczerpania zapasów**JY-1302****MARCO**deszczownia ze słuchawką  
1-funkcyjną**I** GRUPA RABATOWA

indeks	pakow. 	cena netto [zł]
<b>35-200-0037-000</b>	1 1	<b>113,27</b>



20 x 20 cm

10  
x 10 cm**HY-1290****MASSIMO**deszczownia ze słuchawką  
1-funkcyjną**I** GRUPA RABATOWA

indeks	pakow. 	cena netto [zł]
<b>35-200-0038-000</b>	1 1	<b>100,81</b>



20 x 20 cm



10 x 10 cm

**TS-1337****MATTEO**deszczownia ze słuchawką  
1-funkcyjną**I** GRUPA RABATOWA

indeks	pakow. 	cena netto [zł]
<b>35-200-0032-000</b>	1 1	<b>77,66</b>



20 x 20 cm

10  
x 10 cm**JY-1504****MAURO**deszczownia ze słuchawką  
1-funkcyjną**I** GRUPA RABATOWA

indeks	pakow. 	cena netto [zł]
<b>35-200-0036-000</b>	1 1	<b>87,82</b>

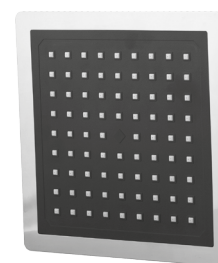

20 x 20 cm

9,5  
x 9,5 cm

**TS-1128**

**MAXIMO**  
deszczownia ze słuchawką  
1-funkcyjną



**I** GRUPA RABATOWA

indeks	pakow.	cena netto [zł]
<b>35-200-0031-000</b>	1 1	<b>68,73</b>

**HY-1310**

**CAMBIO/GOMERA**  
słuchawka prysznicowa  
1-funkcyjna



**I** GRUPA RABATOWA

indeks	pakow.	cena netto [zł]
<b>35-101-0014-000</b>	1 100	<b>14,98</b>

**HY-151B**

**PETRA**  
słuchawka prysznicowa  
1-funkcyjna



**N** GRUPA RABATOWA

**NEXE**  
new line

indeks	pakow.	cena netto [zł]
<b>36-101-0000-003</b>	1 100	<b>21,70</b>

**HY-026**

**RETINA**  
słuchawka prysznicowa  
1-funkcyjna



**N** GRUPA RABATOWA

**NEXE**  
new line

indeks	pakow.	cena netto [zł]
<b>36-101-0001-000</b>	1 100	<b>23,37</b>

**SH-1007**

**ALA**  
słuchawka prysznicowa  
1-funkcyjna



**I** GRUPA RABATOWA

indeks	pakow.	cena netto [zł]
<b>35-100-0001-000</b>	1 200	<b>13,81</b>

**NA-1151P**

**AZUR**  
słuchawka prysznicowa  
1-funkcyjna



**I** GRUPA RABATOWA

indeks	pakow.	cena netto [zł]
<b>35-101-0007-000</b>	1 40	<b>21,04</b>



**TS-1787****ANDREA**

słuchawka zlewozmywakowa  
2-funkcyjna do baterii  
z wymiową wylewką



**I** GRUPA RABATOWA

indeks	pakow. ☐ ☐	cena netto [zł]
<b>35-102-0002-000</b>	1 40	<b>40,57</b>

**SH-2005****KINGA**

słuchawka zlewozmywakowa  
2-funkcyjna do baterii  
z wymiową wylewką



**I** GRUPA RABATOWA

indeks	pakow. ☐ ☐	cena netto [zł]
<b>35-100-0006-000</b>	1 40	<b>40,57</b>

**HY-1406****GERTA**

słuchawka prysznicowa  
3-funkcyjna



**N** GRUPA RABATOWA

**NEXE**  
new line

indeks	pakow. ☐ ☐	cena netto [zł]
<b>36-103-0002-000</b>	1 20	<b>30,09</b>



funkcja  
STOP

**HY-001B****MORENA**

słuchawka prysznicowa  
3-funkcyjna



**N** GRUPA RABATOWA

**NEXE**  
new line

indeks	pakow. ☐ ☐	cena netto [zł]
<b>36-103-0000-103</b>	1 20	<b>52,09</b>



Wciśnij przycisk,  
aby zmienić funkcję  
strumienia wody!

**HY-018C****NOEMI**

słuchawka prysznicowa  
3-funkcyjna



**N** GRUPA RABATOWA

**NEXE**  
new line

indeks	pakow. ☐ ☐	cena netto [zł]
<b>36-103-0005-000</b>	1 20	<b>37,04</b>

**HY-002B****TREVIA**

słuchawka prysznicowa  
3-funkcyjna



**N** GRUPA RABATOWA

**NEXE**  
new line

indeks	pakow. ☐ ☐	cena netto [zł]
<b>36-103-0001-103</b>	1 20	<b>52,09</b>



Wciśnij przycisk,  
aby zmienić funkcję  
strumienia wody!

**HY-006**

**WEDERA**  
słuchawka prysznicowa  
3-funkcyjna



**(N)** GRUPA RABATOWA

**NEXE**  
new line

indeks	pakow.	cena netto [zł]
<b>36-103-0004-000</b>	1 20	<b>30,09</b>



**Czyszczenie mechaniczne**

**NA-1235**

**GAZELA**  
słuchawka prysznicowa  
3-funkcyjna



**(I)** GRUPA RABATOWA

indeks	pakow.	cena netto [zł]
<b>35-103-0009-000</b>	1 50	<b>24,39</b>

**NA-1115B**

**BORNEO**  
słuchawka prysznicowa  
3-funkcyjna



**(I)** GRUPA RABATOWA

indeks	pakow.	cena netto [zł]
<b>35-103-0005-000</b>	1 25	<b>39,38</b>

**NA-1113X**

**ITAKA**  
słuchawka prysznicowa  
3-funkcyjna



**(I)** GRUPA RABATOWA

indeks	pakow.	cena netto [zł]
<b>35-103-0003-000</b>	1 50	<b>22,63</b>

**NA-1113**

**FIDZI**  
słuchawka prysznicowa  
3-funkcyjna



**(I)** GRUPA RABATOWA

indeks	pakow.	cena netto [zł]
<b>35-103-0010-000</b>	1 40	<b>23,45</b>

**NA-1113S**

**TRIO**  
słuchawka prysznicowa  
3-funkcyjna



**(I)** GRUPA RABATOWA

indeks	pakow.	cena netto [zł]
<b>35-103-0004-000</b>	1 50	<b>29,86</b>



**HY-053**

**MARINI**  
słuchawka prysznicowa  
5-funkcyjna



**(N)** GRUPA RABATOWA

**NEXE**  
new line

indeks	pakow.	cena netto [zł]
<b>36-105-0003-000</b>	1 50	<b>33,39</b>



**NA-1223**

**BRAVA**  
słuchawka prysznicowa  
5-funkcyjna



**(I)** GRUPA RABATOWA

indeks	pakow.	cena netto [zł]
<b>35-105-0003-000</b>	1 20	<b>39,25</b>



**TS-1124**

**SIMONA**  
słuchawka prysznicowa  
5-funkcyjna



**(I)** GRUPA RABATOWA

indeks	pakow.	cena netto [zł]
<b>35-105-0008-000</b>	1 30	<b>43,74</b>



**BD-9009**

**LANGUSTA**  
drążek prysznicowy  
z przysawką

**(I)** GRUPA RABATOWA

indeks	pakow.	cena netto [zł]
<b>35-200-0043-000</b>	1 10	<b>123,49</b>

Produkt dostępny  
do wyczerpania zapasów



ok.  $\varnothing$ 22,5 mm  
Możliwość regulacji



**TS-4017**

**REMO**  
drążek prysznicowy z mydelniczką  
dł. 60cm

**(I)** GRUPA RABATOWA

indeks	pakow.	cena netto [zł]
<b>35-200-0040-000</b>	1 20	<b>101,88</b>



**TS-4023**

**ROBERTO**  
drążek prysznicowy  
dł. 64cm

**(I)** GRUPA RABATOWA

indeks	pakow.	cena netto [zł]
<b>35-200-0039-000</b>	1 20	<b>87,98</b>

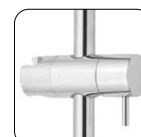

**NA-1112PD****ZANZIBAR**

drążek prysznicowy z mydelniczką

I GRUPA RABATOWA

indeks	pakow.	cena netto [zł]
35-200-0015-000	1 10	93,15

**NA123WD****PASJA**

Drążek wygięty z półką

I GRUPA RABATOWA

**NEXE**  
new line

indeks	pakow.	cena netto [zł]
35-200-0016-000	1 20	91,60

**R10N**

Ramię prysznicowe dla zestawów podtynkowych z deszczownicą

N GRUPA RABATOWA

**NEXE**  
new line

indeks	pakow.	cena netto [zł]
36-107-0000-000	1 1	264,82

Produkt dostępny do wyczerpania zapasów

**BR9015****KORAL**

uchwyt punktowy prysznicowy

I GRUPA RABATOWA

indeks	pakow.	cena netto [zł]
35-200-0044-000	1 500	7,43

**BR-9005M****KRAB**

uchwyt punktowy prysznicowy

I GRUPA RABATOWA

indeks	pakow.	cena netto [zł]
35-200-0018-000	1 100	24,77

**BR-9009****LANGUSTA**

uchwyt punktowy prysznicowy z przysawką

I GRUPA RABATOWA

indeks	pakow.	cena netto [zł]
35-200-0028-000	1 100	36,69

Produkt dostępny do wyczerpania zapasów





**BR9008****RAK**  
uchwyt punktowy prysznicowy**I** GRUPA RABATOWA

indeks	pakow. ☐ ☐	cena netto [zł]
<b>35-200-0019-000</b>	1 200	<b>7,73</b>

**P9**

Uchwyt punktowy

**N** GRUPA RABATOWA**NEXE**  
new line

indeks	pakow. ☐ ☐	cena netto [zł]
<b>36-103-0000-000</b>	1 100	<b>31,00</b>

**R10**Uchwyt punktowy z ruchomą  
końcówką**N** GRUPA RABATOWA**NEXE**  
new line

indeks	pakow. ☐ ☐	cena netto [zł]
<b>36-103-0000-003</b>	1 100	<b>26,55</b>

**HS-019**Wąż prysznicowy wzmocniony  
½" x ½"**I** GRUPA RABATOWA

indeks	wąż [cm]	pakow. ☐ ☐	cena netto [zł]
<b>35-400-1200-000</b>	120	1 60	<b>23,44</b>
<b>35-400-1500-000</b>	150	1 60	<b>25,42</b>
<b>35-400-1750-000</b>	175	1 60	<b>28,37</b>
<b>35-400-2000-000</b>	200	1 60	<b>32,23</b>

**HS-020**Wąż prysznicowy elastyczny -  
rozciągliwy ½"x½"**I** GRUPA RABATOWA

indeks	wąż [cm]	pakow. ☐ ☐	cena netto [zł]
<b>35-401-1200-000</b>	120-150	1 50	<b>38,65</b>
<b>35-401-1500-000</b>	150-180	1 30	<b>45,23</b>
<b>35-401-1750-000</b>	175-210	1 50	<b>46,12</b>

**P4CM**

Wąż prysznicowy

**N** GRUPA RABATOWA**NEXE**  
new line

indeks	wąż [cm]	pakow. ☐ ☐	cena netto [zł]
<b>36-117-0150-003</b>	150	1 50	<b>44,60</b>



**P4S**

Wąż prysznicowy

**(N)** GRUPA RABATOWA**NEXE**  
new line

indeks	wąż [cm]	pakow.	cena netto [zł]
<b>36-115-0150-008</b>	150	1 50	<b>44,60</b>

**P19CM**

Wąż prysznicowy

**(N)** GRUPA RABATOWA**NEXE**  
new line

indeks	wąż [cm]	pakow.	cena netto [zł]
<b>36-116-0150-003</b>	150	1 50	<b>35,00</b>

**HS-018**

Wąż do baterii z wymiową wylewką, M15x1 x 1/2"

**(I)** GRUPA RABATOWA

indeks	wąż [cm]	pakow.	cena netto [zł]
<b>35-402-1200-100</b>	120	1 50	<b>22,59</b>

**NA-12H**

Wąż prysznicowy 1/2" x 1/2" „Bamboo”

**(I)** GRUPA RABATOWA

indeks	wąż [cm]	pakow.	cena netto [zł]
<b>35-402-1500-000</b>	150	1 60	<b>23,56</b>

Produkt dostępny do wyczerpania zapasów

**BT-9009****LANGUSTA**  
zawieszanie do ręcznika z przyssawką**(I)** GRUPA RABATOWA

indeks	pakow.	cena netto [zł]
<b>35-308-0000-300</b>	1 10	<b>90,95</b>

Produkt dostępny do wyczerpania zapasów

**BS-9009****LANGUSTA**  
mydelniczka z przyssawką**(I)** GRUPA RABATOWA

indeks	pakow.	cena netto [zł]
<b>35-310-0000-000</b>	1 50	<b>57,89</b>

Produkt dostępny do wyczerpania zapasów



**BPK-9009****LANGUSTA**zawieszanie do papieru  
toaletowego z przyssawką

I GRUPA RABATOWA

indeks	pakow. ☐ ☐	cena netto [zł]
<b>35-308-0000-100</b>	1 20	<b>66,14</b>

Produkt dostępny  
do wyczerpania zapasów**BPS-9009****LANGUSTA**zawieszanie do papieru  
toaletowego z przyssawką

I GRUPA RABATOWA

indeks	pakow. ☐ ☐	cena netto [zł]
<b>35-308-0000-200</b>	1 50	<b>52,57</b>

Produkt dostępny  
do wyczerpania zapasów**BPR-9009****LANGUSTA**zawieszanie do ręcznika  
z przyssawką

I GRUPA RABATOWA

indeks	pakow. ☐ ☐	cena netto [zł]
<b>35-308-0000-000</b>	1 20	<b>66,14</b>

Produkt dostępny  
do wyczerpania zapasów**BB-9009****LANGUSTA**

szczotka do WC z przyssawką

I GRUPA RABATOWA

indeks	pakow. ☐ ☐	cena netto [zł]
<b>35-309-0000-000</b>	1 10	<b>99,21</b>

Produkt dostępny  
do wyczerpania zapasów**BS-9009/1****LANGUSTA**adapter do akcesoriów  
z przyssawką do nierównych  
powierzchni

I GRUPA RABATOWA

indeks	pakow. ☐ ☐	cena netto [zł]
<b>35-311-0000-000</b>	1 400	<b>10,04</b>

Produkt dostępny  
do wyczerpania zapasów**BD-9009/1****LANGUSTA**adapter do drążka BD-9009  
do nierównych powierzchni

I GRUPA RABATOWA

indeks	pakow. ☐ ☐	cena netto [zł]
<b>35-311-0000-100</b>	1 200	<b>10,04</b>

Produkt dostępny  
do wyczerpania zapasów



## AKCESORIA/ CZĘŚCI DO BATERII 124-127

Perlatory	125
Przedłużki i pokrętła	126
Głowice do baterii	126
Wylewki do baterii	127
Inne akcesoria	127

**P1****NEXE ECO**  
perlator do baterii**NEXE**  
new line

indeks	wielkość	pakowanie		cena netto [zł]
<b>36-114-0001-000</b>	M24 x GZ1"	1	250	<b>16,00</b>



GRUPA RABATOWA

**P2****NEXE ECO**  
perlator do baterii**NEXE**  
new line

indeks	wielkość	pakowanie		cena netto [zł]
<b>36-114-0000-000</b>	M22 x GW1"	1	250	<b>16,00</b>



GRUPA RABATOWA

**08**

Perlator do baterii



indeks	wielkość	pakowanie		cena netto [zł]
<b>35-301-0000-000</b>	M22 x GW1"	25	2000	<b>4,41</b>



GRUPA RABATOWA

**09**

Perlator do baterii



indeks	wielkość	pakowanie		cena netto [zł]
<b>35-301-0006-000</b>	M24 x GZ1"	100	1000	<b>4,41</b>



GRUPA RABATOWA

**10**

Perlator do baterii



indeks	wielkość	pakowanie		cena netto [zł]
<b>35-301-0001-000</b>	M28 x GZ1"	10	1000	<b>8,82</b>



GRUPA RABATOWA

**NA-PR1P****TUKAN**  
perlator długi z redukcją  
2-funkcyjny długi wąż tworzywowy

indeks	pakowanie		cena netto [zł]
<b>35-301-0003-000</b>	1	100	<b>15,85</b>



GRUPA RABATOWA

**NA-PR2****PELIKAN**  
perlator długi z redukcją  
2-funkcyjny długi wąż chromowany

indeks	pakowanie		cena netto [zł]
<b>35-301-0004-000</b>	1	100	<b>19,97</b>



GRUPA RABATOWA

**NA-PR3P****ARA**  
perlator z redukcją 2-funkcyjny  
na przegubie krótkim

indeks	pakowanie		cena netto [zł]
<b>35-301-0005-000</b>	1	100	<b>15,85</b>



GRUPA RABATOWA

**BR9045****KOLIBER**

Perlator krótki z redukcją  
2-funkcyjny



indeks	pakowanie		cena netto [zł]
	☐	☐	
<b>35-301-0002-000</b>	1	100	<b>10,59</b>

I GRUPA RABATOWA

**PHA-351**

Przedłużka pod baterię  
naścienną mosiężna  
chromowana WZ

**PERFEKT<sup>2</sup>SYSTEM**

indeks	wielkość	PN	Tmax	pakowanie		cena netto [zł]
				☐	☐	
<b>07-351-0200-000</b>	¾"	16	+180°C	20	180	<b>17,71</b>

D GRUPA RABATOWA

**H511**

Pokrętło baterii  
2-uchwytowych PRIMULA



indeks	wielkość	kolor	pakowanie		cena netto [zł]
			☐	☐	
<b>35-300-0000-000</b>	½" x ¾"	niebieski lub czerwony	50	400	<b>7,10</b>

I GRUPA RABATOWA

**POLONIA**

**POLONIA**  
głowica do baterii  
2-uchwytowych



indeks	wielkość	typ	pakowanie		cena netto [zł]
			☐	☐	
<b>35-302-0000-010</b>	¾"	dziewczynka	50	400	<b>7,07</b>
<b>35-302-0000-000</b>	½"	dziewczynka	30	240	<b>9,47</b>
<b>35-302-0000-100</b>	½"	chłopiec	30	240	<b>9,47</b>

I GRUPA RABATOWA

**10C/10N**

Głowica ceramiczna prawa  
do baterii 2-uchwytowych



indeks	typ	kolor	pakowanie		cena netto [zł]
			☐	☐	
<b>35-302-0001-000</b>	prawa	czerwona	1	400	<b>14,03</b>
<b>35-302-0001-100</b>	prawa	niebieska	1	400	<b>14,03</b>

I GRUPA RABATOWA

**C201/C202**

Głowica ceramiczna  
do baterii 1-uchwytowych



indeks	wielkość	typ	symbol	pakowanie		cena netto [zł]
				☐	☐	
<b>35-302-0002-350</b>	35	niska	C201	1	100	<b>16,55</b>
<b>35-302-0003-350</b>	35	wysoka	C202	1	100	<b>16,55</b>
<b>35-302-0002-400</b>	40	niska	C201	1	100	<b>16,90</b>
<b>35-302-0003-400</b>	40	wysoka	C202	1	100	<b>16,90</b>

I GRUPA RABATOWA

**07**

Mimośród do baterii



indeks	wielkość	pakowanie		cena netto [zł]
		☐	☐	
<b>35-303-0000-000</b>	½" x ¾"	2	320	<b>13,32</b>

I GRUPA RABATOWA

**WL1**

Wylewka płaska do baterii,  
wygięta, nakrętki 3/4"



I GRUPA RABATOWA

indeks	wielkość	typ	nakrętki	pakowanie		cena netto [zł]
<b>35-304-0000-300</b>	14 cm	wygięta	3/4"	1	100	<b>33,16</b>
<b>35-304-0000-100</b>	16 cm	wygięta	3/4"	1	100	<b>35,07</b>
<b>35-304-0000-200</b>	22 cm	wygięta	3/4"	1	100	<b>44,66</b>

**WL2C**

Wylewka rurkowa  
do baterii



I GRUPA RABATOWA

indeks	wielkość	typ	nakrętki	pakowanie		cena netto [zł]
<b>35-304-0000-400</b>	16 cm	C	1/2"	1	50	<b>27,13</b>
<b>35-304-0000-500</b>	25 cm	C	1/2"	1	50	<b>30,29</b>

**WL2S**

Wylewka rurkowa  
do baterii



I GRUPA RABATOWA

indeks	wielkość	typ	nakrętki	pakowanie		cena netto [zł]
<b>35-304-0000-600</b>	16 cm	S	1/2"	1	50	<b>27,13</b>
<b>35-304-0000-700</b>	25 cm	S	1/2"	1	50	<b>30,29</b>

**DIV-1**

Przełącznik mechaniczny  
do baterii wannowej



I GRUPA RABATOWA

indeks	pakowanie		cena netto [zł]
<b>35-306-0000-000</b>	50	400	<b>14,67</b>

UNIWERSALNE ZASTOSOWANIE, NIEZALEŻNIE OD CIŚNIENIA W INSTALACJI

**PAD-1**

Stabilizator do mocowania  
baterii stojących



I GRUPA RABATOWA

indeks	pakowanie		cena netto [zł]
<b>35-307-0000-000</b>	1	500	<b>5,26</b>

**A.695/09004W**

Zaślepka



E GRUPA RABATOWA

indeks	pakowanie		cena netto [zł]
<b>98-035-0001-000</b>	100	1000	<b>13,70</b>

**A.695/09004C**

Zaślepka



E GRUPA RABATOWA

indeks	pakowanie		cena netto [zł]
<b>98-035-0002-000</b>	100	1000	<b>14,20</b>



Możliwość rozciągnięcia  
i kształtowania

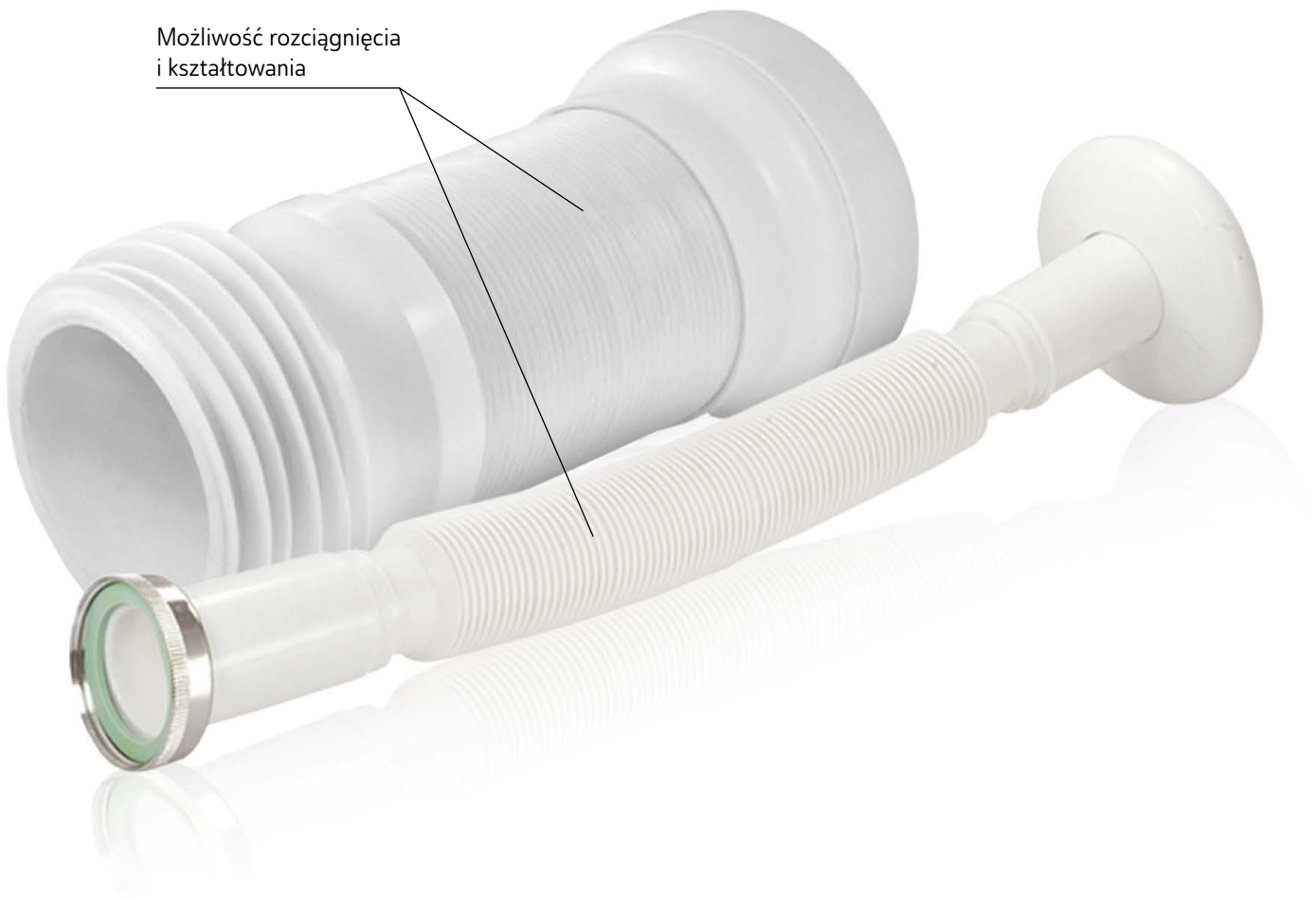

# ARMATURA SANITARNA 128-129

Przyłącza

129

Węże do pralki

129



## 969

Przyłącze elastyczne ABS



indeks	wielkość	pakowanie		cena netto [zł]
<b>40-969-3232-000</b>	1¼ x 32	1	100	<b>8,13</b>
<b>40-969-4050-000</b>	1½ x 40/50	1	100	<b>9,78</b>

**E** GRUPA RABATOWA

## 991

Przyłącze rozciągliwe WC



indeks	pakowanie		cena netto [zł]
<b>40-991-0000-000</b>	1	30	<b>29,79</b>

**E** GRUPA RABATOWA

## 997

Łącznik mimośrodowy WC



indeks	pakowanie		cena netto [zł]
<b>40-997-0000-000</b>	1	60	<b>9,83</b>

**E** GRUPA RABATOWA

Produkt dostępny do wyczerpania zapasów

## 998

Łącznik prosty WC



indeks	pakowanie		cena netto [zł]
<b>40-998-0000-000</b>	1	60	<b>9,83</b>

**E** GRUPA RABATOWA

Produkt dostępny do wyczerpania zapasów

## 96C/96W

Syfon do pralki natynkowy



indeks	kolor	pakowanie		cena netto [zł]
<b>40-961-0000-000</b>	chrom	1	100	<b>15,98</b>
<b>40-960-0000-000</b>	biały	1	100	<b>11,48</b>

**E** GRUPA RABATOWA

## 291

Wąż zasilający do pralki ¾" x ¾"



indeks	wielkość	pakowanie		cena netto [zł]
<b>35-403-1500-000</b>	150	1	10	<b>19,20</b>
<b>35-403-2000-000</b>	200	1	10	<b>19,39</b>
<b>35-403-2500-000</b>	250	1	10	<b>22,71</b>
<b>35-403-3000-000</b>	300	1	10	<b>25,19</b>

**C** GRUPA RABATOWA

## 306

Wąż odprowadzający do pralki



indeks	wielkość	pakowanie		cena netto [zł]
<b>35-404-1500-000</b>	150	1	1	<b>12,08</b>
<b>35-405-2000-000</b>	200	1	1	<b>13,90</b>
<b>35-405-2500-000</b>	250	1	1	<b>19,13</b>
<b>35-404-3000-000</b>	300	1	1	<b>16,32</b>

**C** GRUPA RABATOWA



## WARUNKI RABATÓW

grupa	
A	
B	
C	
D	
E	
G	
H	
HS	
I	
J	
K	
K1	
K2	
K3	
L	
N	
P	
Z	



### **ZŁOTY LAUR KONSUMENTA**

w kategorii Producent i importer  
branży instalacyjno-grzewczej, łazienkowej i sanitarnej

### **LAUR KONSUMENTA - ODKRYCIE ROKU**

w kategorii Polska jakość branży budowlanej.  
Jakość produktów, usług i obecność w świadomości  
konsumentów

Niniejszy cennik nie stanowi oferty w rozumieniu przepisów Kodeksu Cywilnego i jest tylko informacją wstępną. Do zawarcia indywidualnej umowy może dojść wyłącznie po uzgodnieniu istotnych jej postanowień. Równocześnie Producent zastrzega sobie prawo do wprowadzenia zmian i modyfikacji cen oraz danych technicznych produktów wymienionych w niniejszym Cenniku, a także zmian wynikających z mogących wystąpić błędów lub pomyłek.

Zdjęcia produktów mają charakter poglądowy.  
Do podanych cen netto należy doliczyć podatek VAT w wysokości 23%.

Perfexim spółka z ograniczoną odpowiedzialnością  
ul. Samotna 2, 61-441 Poznań, Polska